

# easYgen-3000 Series

Manual | Genset Control



**easYgen-3100/3200 P1/P2**

Software Version 1.2109 or higher

37532F

This is no translation but the original Technical Manual.  
Designed in Germany.

**Woodward GmbH**

Handwerkstrasse 29

70565 Stuttgart

Germany

Telephone: +49 (0) 711 789 54-510

Fax: +49 (0) 711 789 54-101

Email: [stgt-info@woodward.com](mailto:stgt-info@woodward.com)

Internet: <http://www.woodward.com>

© 2015

## Brief Overview

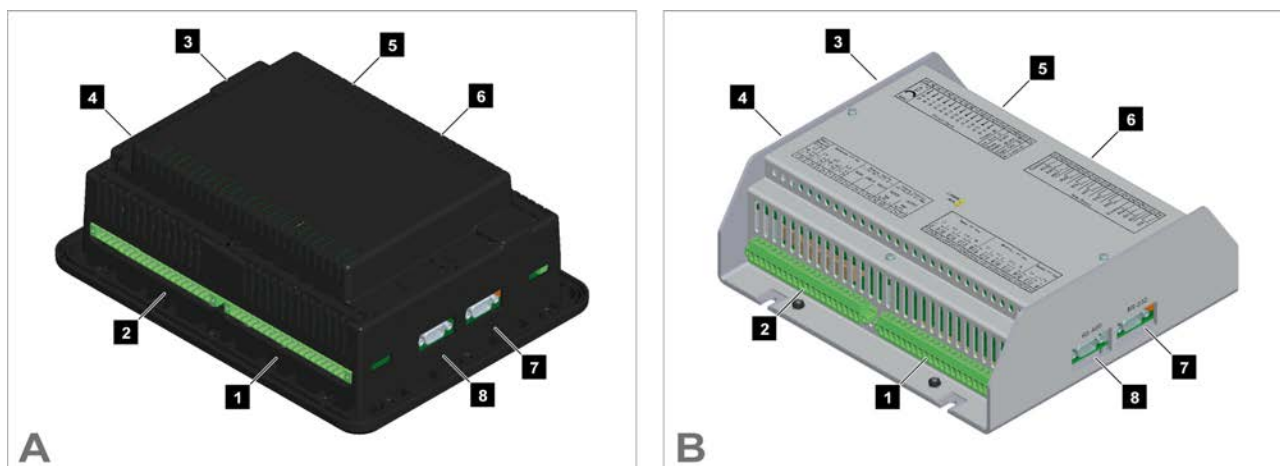

Fig. 1: easYgen-3000 Series (housing variants)

A easYgen-3200 (plastic housing with display)

B easYgen-3100 (sheet metal housing)

1 Mains/generator/busbar PT terminal

2 Analog inputs/outputs and generator CT terminal

3 CAN bus interface connector #1

4 CAN bus interface connector #2

5 Discrete inputs terminal

6 Relay outputs terminal

7 RS-232 interface connector

8 RS-485 interface connector

The easYgen-3000 Series are control units for engine-generator system management applications.

The control units can be used in applications such as: co-generation, stand-by, AMF, peak shaving, import/export or distributed generation.

The easYgen-3000 Series is also applicable for island, island parallel, mains parallel and multiple unit mains parallel operations.

Sample application setup

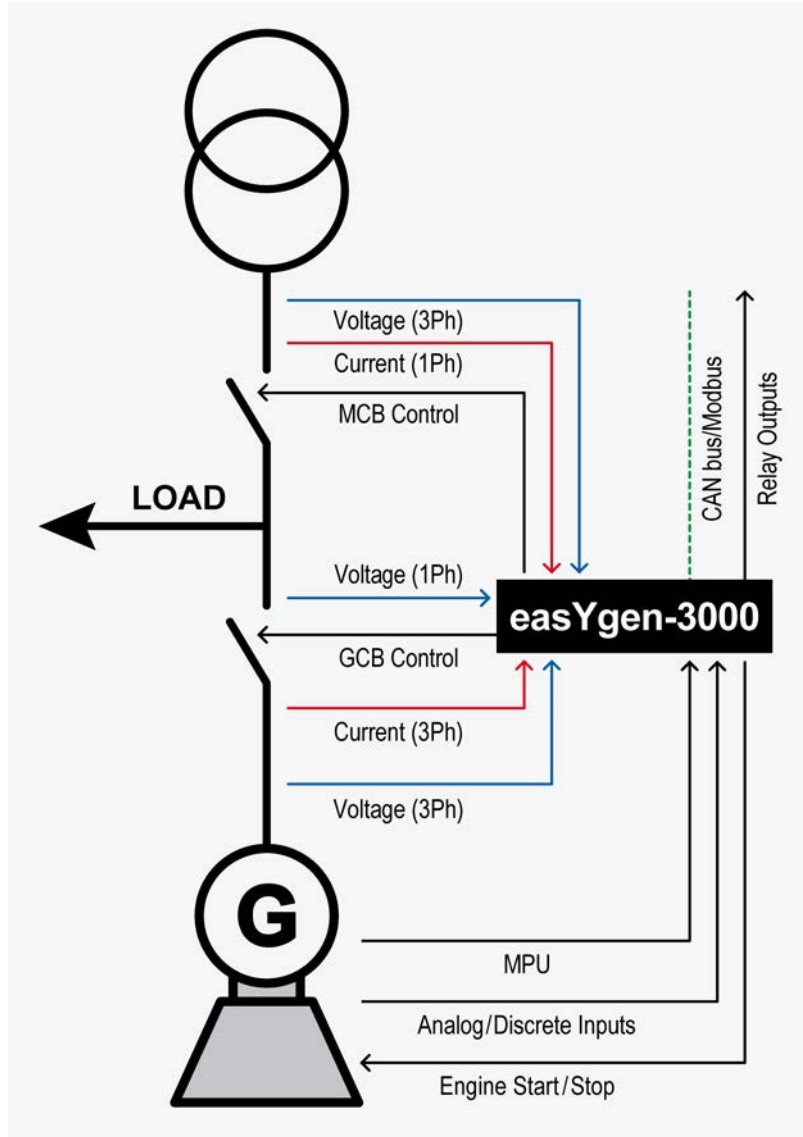

Fig. 2: Sample application setup

A typical application mode for the control unit is the use for mains parallel operation.

- In this case, the easYgen will function as an engine control with generator, mains and engine protection.
- The control unit can open and close the generator circuit breaker (GCB) and the mains circuit breaker (MCB).



For a listing of additional application modes and setups please refer to chapter 6 “Application” on page 417.

Packages



The easYgen-3100/3200 controllers are available in different packages. The differences are listed below.

easYgen-3100/3200	Package P1	Package P2
Freely configurable PID controllers	—	3
External discrete inputs / outputs via CANopen (maximum)	16 / 16	32 / 32
External analog inputs / outputs via CANopen (maximum)	—	16 / 4

**Scope of delivery**

The following parts are included in the scope of delivery. Please check prior to the installation that all parts are present.

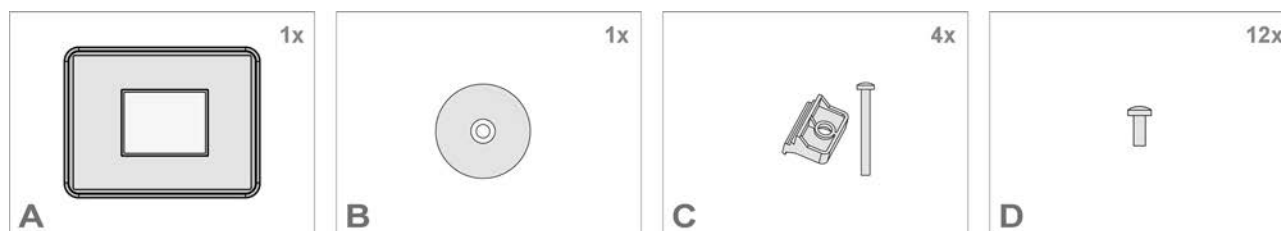

*Fig. 3: Scope of delivery - schematic*

- A easYgen-3100/3200 genset control
- B Product CD (configuration software and manual)
- C Clamp fastener installation material - 4x (easYgen-3200 only)
- D Screw kit installation material - 12x (easYgen-3200 only)



## Table of contents

<b>1</b>	<b>General Information</b> .....	<b>17</b>
1.1	About This Manual.....	17
1.1.1	Revision History.....	17
1.1.2	Depiction Of Notes And Instructions.....	23
1.2	Copyright And Disclaimer.....	24
1.3	Service And Warranty.....	25
1.4	Safety.....	25
1.4.1	Intended Use.....	25
1.4.2	Personnel.....	26
1.4.3	General Safety Notes.....	27
1.4.4	Protective Equipment And Tools.....	30
<b>2</b>	<b>System Overview</b> .....	<b>33</b>
2.1	Display And Status Indicators.....	33
2.2	Hardware Interfaces (Terminals).....	34
2.3	Application Modes Overview.....	35
<b>3</b>	<b>Installation</b> .....	<b>37</b>
3.1	Mount Unit (Sheet Metal Housing).....	37
3.2	Mount Unit (Plastic Housing).....	39
3.2.1	Clamp Fastener Installation.....	40
3.2.2	Screw Kit Installation.....	41
3.3	Setup Connections.....	42
3.3.1	Terminal Allocation.....	42
3.3.2	Wiring Diagram.....	43
3.3.3	Power Supply.....	45
3.3.4	Charging Alternator.....	46
3.3.5	Voltage Measuring.....	47
3.3.5.1	Generator Voltage.....	47
3.3.5.2	Mains Voltage.....	55
3.3.5.3	Busbar Voltage.....	61
3.3.6	Current Measuring.....	64
3.3.6.1	Generator Current.....	64
3.3.6.2	Mains Current.....	66
3.3.6.3	Ground Current.....	67
3.3.7	Power Measuring.....	68
3.3.8	Power Factor Definition.....	69
3.3.9	Magnetic Pickup Unit (MPU).....	70
3.3.10	Discrete Inputs.....	71
3.3.11	Relay Outputs (LogicsManager).....	73

3.3.12	Analog Inputs (0 to 500 Ohm   0/4 to 20 mA).....	74
3.3.13	Analog Outputs.....	77
3.3.13.1	Analog Outputs ( $\pm 20$ mA, $\pm 10$ V, PWM).....	77
3.3.14	Serial Interfaces.....	78
3.3.14.1	RS-485 Interface.....	78
3.3.14.2	RS-232 Interface.....	79
3.4	CAN Bus Interfaces.....	80
3.5	Connecting 24 V Relays.....	82
<b>4</b>	<b>Configuration.....</b>	<b>85</b>
4.1	Basic Setup.....	85
4.1.1	Configure Language/Clock.....	85
4.1.2	Configure Display.....	89
4.1.3	Lamp Test.....	89
4.1.4	Enter Password.....	89
4.1.5	System Management.....	92
4.1.6	Password System.....	93
4.2	Configure Measurement.....	94
4.2.1	Configure Transformer.....	99
4.2.2	External Mains Active Power.....	102
4.2.3	External Mains Reactive Power.....	103
4.3	Function Of Inputs And Outputs.....	103
4.3.1	Discrete Inputs.....	103
4.3.2	Discrete Outputs.....	106
4.4	Configure Monitoring.....	109
4.4.1	Generator.....	109
4.4.1.1	Generator Operating Voltage / Frequency.....	110
4.4.1.2	Generator Overfrequency (Level 1 & 2) ANSI# 81O.....	110
4.4.1.3	Generator Underfrequency (Level 1 & 2) ANSI# 81U.....	112
4.4.1.4	Generator Overvoltage (Level 1 & 2) ANSI# 59.....	113
4.4.1.5	Generator Undervoltage (Level 1 & 2) ANSI# 27.....	115
4.4.1.6	Generator Time-Overcurrent (Level 1, 2 & 3) ANSI# 50/51.....	116
4.4.1.7	Generator Reverse/Reduced Power (Level 1 & 2) ANSI# 32R/F.....	117
4.4.1.8	Generator Overload IOP (Level 1 & 2) ANSI# 32.....	119
4.4.1.9	Generator Overload MOP (Level 1 & 2) ANSI# 32.....	121
4.4.1.10	Generator Unbalanced Load (Level 1 & 2) ANSI# 46.....	122
4.4.1.11	Generator Voltage Asymmetry.....	124
4.4.1.12	Generator Ground Fault (Level 1 & 2).....	125
4.4.1.13	Generator Phase Rotation.....	129
4.4.1.14	Generator Inverse Time-Overcurrent ANSI# IEC 255.....	131
4.4.1.15	Generator Lagging Power Factor (Level 1 & 2).....	134
4.4.1.16	Generator Leading Power Factor (Level 1 & 2).....	136



---

4.4.1.17	Generator Voltage Restrained Overcurrent Monitoring - ANSI #51.....	137
4.4.2	Mains.....	139
4.4.2.1	Mains Operating Voltage / Frequency.....	139
4.4.2.2	Mains Decoupling.....	140
4.4.2.3	Mains Overfrequency (Level 1 & 2) ANSI# 81O.....	147
4.4.2.4	Mains Underfrequency (Level 1 & 2) ANSI# 81U.....	148
4.4.2.5	Mains Overvoltage (Level 1 & 2) ANSI# 59.....	149
4.4.2.6	Mains Undervoltage (Level 1 & 2) ANSI# 27.....	151
4.4.2.7	Mains Voltage Increase.....	152
4.4.2.8	Mains Time-Dependent Voltage.....	154
4.4.2.9	QV Monitoring.....	157
4.4.2.10	Change Of Frequency.....	159
4.4.2.11	Mains Voltage Phase Rotation.....	163
4.4.2.12	Mains Import Power (Level 1 & 2).....	164
4.4.2.13	Mains Export Power (Level 1 & 2).....	166
4.4.2.14	Mains Lagging Power Factor (Level 1 & 2).....	167
4.4.2.15	Mains Leading Power Factor (Level 1 & 2).....	169
4.4.2.16	Blocking of Mains Protection.....	170
4.4.3	Engine.....	171
4.4.3.1	Engine Overspeed (Level 1 & 2) ANSI# 12.....	171
4.4.3.2	Engine Underspeed (Level 1 & 2).....	172
4.4.3.3	Engine/Generator Speed Detection.....	173
4.4.3.4	Engine/Generator Active Power Mismatch.....	175
4.4.3.5	Engine/Mains Active Power Mismatch.....	176
4.4.3.6	Engine/Generator Unloading Mismatch.....	177
4.4.3.7	Engine Start Failure.....	178
4.4.3.8	Engine Shutdown Malfunction .....	178
4.4.3.9	Engine Unintended Stop .....	179
4.4.3.10	Engine Operating Range Failure.....	180
4.4.3.11	Engine Charge Alternator (D+).....	181
4.4.3.12	Cylinder Temperature.....	182
4.4.4	Breaker.....	188
4.4.4.1	Configure GCB.....	188
4.4.4.2	Synchronization GCB .....	189
4.4.4.3	Configure MCB.....	190
4.4.4.4	Synchronization MCB .....	192
4.4.4.5	Generator/Busbar/Mains Phase Rotation.....	193
4.4.5	Flexible Limits.....	194
4.4.6	Miscellaneous.....	199
4.4.6.1	Alarm Acknowledgement.....	199
4.4.6.2	Free Configurable Alarms.....	200
4.4.6.3	CAN Bus Overload.....	201

4.4.6.4	CAN Interface 1.....	202
4.4.6.5	CAN Interface 2.....	203
4.4.6.6	CAN Interface 2 - J1939 Interface.....	204
4.4.6.7	J1939 Interface - Red Stop Alarm.....	205
4.4.6.8	J1939 Interface - Amber Warning Alarm.....	206
4.4.6.9	Battery Overvoltage (Level 1 & 2).....	207
4.4.6.10	Battery Undervoltage (Level 1 & 2).....	208
4.4.6.11	Multi-Unit Parameter Alignment.....	209
4.4.6.12	Multi-Unit Missing Members.....	211
4.4.6.13	Neutral Interlocking.....	212
4.5	Configure Application.....	212
4.5.1	Configure Breakers.....	212
4.5.1.1	Dead Bus Closing GCB.....	213
4.5.1.2	Synchronization GCB/MCB.....	215
4.5.1.3	Dead Bus Closing MCB.....	216
4.5.1.4	Open GCB.....	217
4.5.1.5	Open MCB.....	218
4.5.1.6	Transition Modes (Breaker Logic).....	218
4.5.1.7	Parameters.....	222
4.5.1.8	Breakers GCB.....	225
4.5.1.9	Breakers MCB.....	229
4.5.1.10	Synchronization.....	232
4.5.1.11	Neutral Interlocking.....	234
4.5.2	Inputs And Outputs.....	235
4.5.2.1	Analog Inputs.....	235
4.5.2.2	External Analog Inputs.....	242
4.5.3	Discrete Inputs.....	246
4.5.4	External Discrete Inputs.....	249
4.5.5	Discrete Outputs (LogicsManager).....	251
4.5.6	External Discrete Outputs.....	253
4.5.7	Analog Outputs.....	254
4.5.7.1	Analog Outputs 1 and 2.....	254
4.5.8	External Analog Outputs.....	258
4.5.9	Engine.....	260
4.5.9.1	Engine Type.....	260
4.5.9.2	Engine Start/Stop.....	267
4.5.9.3	Magnetic Pickup Unit.....	273
4.5.9.4	Idle Mode.....	274
4.5.10	Emergency Run.....	276
4.5.11	Automatic Run.....	278
4.5.11.1	Load Dependent Start Stop (LDSS).....	281
4.5.11.2	Critical Mode.....	294

4.5.12	Configure Controller.....	300
4.5.12.1	Frequency Control.....	302
4.5.12.2	Load Control.....	308
4.5.12.3	Derating (Uprating) Of Power .....	315
4.5.12.4	Frequency Depending Derating Of Power.....	321
4.5.12.5	Voltage Control.....	323
4.5.12.6	Power Factor Control.....	327
4.5.12.7	Load Share Control.....	336
4.5.12.8	PID {x} Control.....	347
4.5.12.9	Discrete Raise/Low Function.....	350
4.6	Configure Interfaces.....	352
4.6.1	CAN Interface 1.....	352
4.6.1.1	Additional Server SDOs (Service Data Objects).....	354
4.6.1.2	Receive PDO {x} (Process Data Object).....	355
4.6.1.3	Transmit PDO {x} (Process Data Object).....	358
4.6.2	CAN Interface 2.....	362
4.6.2.1	CANopen Interface.....	362
4.6.2.2	J1939 Interface.....	364
4.6.3	Load Share Parameters.....	369
4.6.4	RS-232 Interface.....	369
4.6.5	RS-485 Interface.....	370
4.6.6	Modbus Protocol.....	370
4.6.7	Modem (Active Call Function).....	372
4.6.8	Enable External DO/AO.....	375
4.7	Configure LogicsManager.....	375
4.8	Configure Counters.....	379
4.8.1	General Counters.....	379
<b>5</b>	<b>Operation.....</b>	<b>383</b>
5.1	Access Via PC (ToolKit).....	383
5.1.1	Install ToolKit.....	383
5.1.2	Install ToolKit Configuration Files.....	385
5.1.3	Configure ToolKit.....	387
5.1.4	Connect ToolKit.....	387
5.1.5	View And Set Values In ToolKit.....	390
5.2	Front Panel Access.....	392
5.2.1	Front Panel.....	393
5.2.2	Basic Navigation.....	394
5.2.3	Standard Menu Screens.....	399
5.2.3.1	Navigation Screens.....	399
5.2.3.2	Status/Monitoring Screens.....	400
5.2.3.3	Value Setting Screens.....	401

5.2.4	Specialised Menu Screens.....	401
5.2.4.1	Main Screen Voltage Display.....	401
5.2.4.2	Alarm List.....	402
5.2.4.3	Sequencing.....	403
5.2.4.4	States easYgen.....	404
5.2.4.5	Setpoints.....	404
5.2.4.6	PID1 - PID3 .....	405
5.2.4.7	Synchroscope (Generator/Busbar And Busbar/Mains).....	406
5.2.4.8	LogicsManager Conditions.....	406
5.2.4.9	LogicsManager.....	407
5.2.4.10	Event History.....	407
5.2.4.11	Mains Decoupling Threshold.....	407
5.2.4.12	Test Mains Decoupling (VDE AR-N 4105).....	408
5.2.4.13	CAN Interface 1/2 State.....	409
5.2.4.14	Genset Bad Parameter Alignment.....	409
5.2.4.15	J1939 Special.....	410
5.2.4.16	Time Indication According To Operating Condition .....	410
5.3	Change Operating Modes.....	411
5.3.1	Operating Mode STOP.....	411
5.3.2	Operating Mode MANUAL.....	412
5.3.3	Operating Mode AUTOMATIC.....	414
5.4	Restore Language Setting via HMI and Softkeys.....	415
<b>6</b>	<b>Application.....</b>	<b>417</b>
6.1	Application Modes Overview.....	417
6.2	Basic Applications.....	418
6.2.1	Application Mode A01 (None).....	418
6.2.2	Application Mode A02 (GCBopen).....	419
6.2.3	Application Mode A03 (GCB).....	421
6.2.4	Application Mode A04 (GCB/MCB).....	423
6.3	Multiple Genset Applications.....	425
6.3.1	Configuring Load-Dependent Start/Stop.....	427
6.3.2	Configuring Automatic Operation.....	429
6.3.3	Configuring Emergency Operation.....	429
6.3.4	Configuring Power Control.....	430
6.4	Special Applications.....	430
6.4.1	Generator Excitation Protection.....	430
6.4.2	Configuring A Setpoint Control Via Analog Input.....	431
6.4.3	Creating Self-Toggling (Pulsing) Relays.....	434
6.4.4	Changing A Starter Battery Set.....	435
6.4.5	Performing Remote Start/Stop And Acknowledgement.....	436
6.4.5.1	Operating Modes.....	437

---

6.4.5.2	Setting Up A Test With Or Without Load.....	438
6.4.5.3	Remote Start/Stop, Shutdown, And Acknowledgement.....	439
6.4.6	Connecting An IKD 1 On CAN Bus 1.....	442
6.4.7	Configuring A PWM Duty Cycle For A CAT ADEM Controller.....	447
6.4.8	Connecting A GSM Modem.....	448
6.4.9	Connecting A Landline Modem.....	453
6.4.10	Wiring Self Powered Discrete Inputs.....	457
6.4.11	Connecting Analog Inputs In Series.....	457
6.4.12	Setup Phoenix Expansion Modules.....	458
6.4.12.1	Configure External Inputs/Outputs (Phoenix).....	462
6.4.13	Phase Angle Compensation.....	465
6.4.14	Start/Stop Logic Mode "Off".....	467
6.4.15	Ripple Control Receiver.....	470
6.4.16	Neutral Interlocking.....	473
6.5	CANopen Applications.....	477
6.5.1	Remote Control.....	477
6.5.1.1	Remote Start/Stop, Shutdown, And Acknowledgement.....	477
6.5.1.2	Transmitting A Frequency Setpoint.....	481
6.5.1.3	Transmitting A Voltage Setpoint.....	483
6.5.1.4	Transmitting A Power Factor Setpoint.....	485
6.5.1.5	Transmitting A Power Setpoint.....	488
6.5.1.6	Transmitting Multiple Setpoints.....	490
6.5.1.7	Remotely Changing The Setpoint.....	491
6.5.1.8	Transmitting A Remote Control Bit.....	494
6.5.2	Sending A Data Protocol via TPDO.....	496
6.5.3	Troubleshooting.....	497
6.6	Modbus Applications.....	498
6.6.1	Remote Control.....	498
6.6.1.1	Remote Start/Stop, Shutdown, And Acknowledgement.....	498
6.6.1.2	Setpoint Setting.....	501
6.6.1.3	Remotely Changing The Setpoint.....	503
6.6.2	Changing Parameter Settings.....	505
6.6.2.1	Parameter Setting.....	505
6.6.2.2	Configuration Of LogicsManager Functions.....	507
6.6.2.3	Configuration Of LogicsManager Functions For Remote Access.....	510
6.6.2.4	Remotely Acknowledge Single Alarm Messages.....	517
6.6.2.5	Remotely Clearing The Event History.....	517
6.6.2.6	Remotely Resetting The Default Values.....	518
6.6.3	Exception Responses.....	520
<b>7</b>	<b>Interfaces And Protocols.....</b>	<b>521</b>
7.1	Interfaces Overview.....	521

---

7.2	CAN Interfaces.....	522
7.2.1	CAN Interface 1 (Guidance level).....	522
7.2.2	CAN Interface 2 (Engine level).....	522
7.3	Serial Interfaces.....	523
7.3.1	RS-232 Interface (Serial Interface 1).....	523
7.3.2	RS-485 Interface (Serial Interface 2).....	524
7.4	CANopen Protocol.....	524
7.5	J1939 Protocol.....	526
7.5.1	Displayed Messages (Visualization).....	527
7.5.2	Supported J1939 ECUs & Remote Control Messages.....	531
7.5.3	Device Type Standard.....	534
7.6	Modbus Protocol.....	536
7.7	Load Sharing.....	540
<b>8</b>	<b>Technical Specifications.....</b>	<b>543</b>
8.1	Technical Data.....	543
8.1.1	Measuring Values.....	543
8.1.2	Ambient Variables.....	544
8.1.3	Inputs/Outputs.....	544
8.1.4	Interface.....	546
8.1.5	Battery.....	547
8.1.6	Housing.....	547
8.1.7	Approvals.....	547
8.1.8	Generic Note.....	548
8.2	Environmental Data.....	548
8.3	Accuracy.....	549
<b>9</b>	<b>Appendix.....</b>	<b>551</b>
9.1	Characteristics.....	551
9.1.1	Triggering Characteristics.....	551
9.1.2	VDO Inputs Characteristics.....	556
9.1.2.1	VDO Input "Pressure" .....	556
9.1.2.2	VDO Input "Temperature" .....	558
9.1.2.3	Pt100 RTD.....	562
9.2	Data Protocols.....	563
9.2.1	CANopen/Modbus.....	563
9.2.1.1	Data Protocol 5003 (Basic Visualization).....	563
9.2.2	CANopen.....	586
9.2.2.1	Protocol 4103 (J1939 Standard Visualization).....	586
9.2.2.2	Protocol 4104 (J1939 Scania S6 Visualization).....	591
9.2.2.3	Protocol 4105 (J1939 Deutz EMR2 Visualization).....	592
9.2.2.4	Protocol 4110 (J1939 MTU ADEC Visualization).....	592

---

9.2.2.5	Protocol 5004 (Generator Values Visualization).....	593
9.2.2.6	Protocol 5005 (Mains Values Visualization).....	598
9.2.2.7	Protocol 5011 (Alarm Values Visualization).....	600
9.2.2.8	Protocol 6000 (Load Share Message).....	619
9.2.2.9	Protocol 65000 (External Discrete I/O 1 to 8).....	625
9.2.2.10	Protocol 65001 (External Discrete I/O 9 to 16).....	625
9.2.3	Modbus.....	626
9.2.3.1	Protocol 5010 (Basic Visualization).....	626
9.2.4	Additional Data Identifier.....	663
9.2.4.1	Transmit Data.....	663
9.2.4.2	Receive Data.....	669
9.3	Analog Manager Reference.....	671
9.3.1	Data Sources.....	671
9.3.1.1	Group 00: Internal Values.....	671
9.3.1.2	Group 01: Generator Values.....	672
9.3.1.3	Group 02: Mains Values.....	673
9.3.1.4	Group 03: Busbar 1 Values.....	674
9.3.1.5	Group 05: Controller Setpoints.....	674
9.3.1.6	Group 06: DC Analog Input Values.....	675
9.3.1.7	Group 07: Engine Values 1 (J1939).....	675
9.3.1.8	Group 08: External Analog Input Values.....	678
9.3.1.9	Group 09: Engine Values 2 (J1939).....	679
9.3.2	Reference Values.....	679
9.3.2.1	Generator Rated Voltage.....	679
9.3.2.2	Mains Rated Voltage.....	680
9.3.2.3	Rated Frequency.....	680
9.3.2.4	Generator Rated Active Power.....	681
9.3.2.5	Generator Rated Reactive Power.....	681
9.3.2.6	Mains Rated Voltage.....	682
9.3.2.7	Mains Rated Reactive Power.....	683
9.3.2.8	Generator Rated Apparent Power.....	683
9.3.2.9	Mains Rated Apparent Power.....	684
9.3.2.10	Generator / Mains Power Factor.....	685
9.3.2.11	Generator Rated Current.....	686
9.3.2.12	Mains Rated Current.....	687
9.3.2.13	Rated Speed.....	687
9.3.2.14	Battery Voltage.....	688
9.3.2.15	Busbar 1 Rated Voltage.....	688
9.3.2.16	Display Value Format.....	688
9.4	LogicsManager Reference.....	689
9.4.1	LogicsManager Overview.....	689
9.4.2	Logical Symbols.....	691

## Table of contents

---

9.4.3	Logical Outputs.....	693
9.4.4	Logical Command Variables.....	697
9.4.4.1	Group 00: Flags Condition 1.....	698
9.4.4.2	Group 01: Alarm System.....	703
9.4.4.3	Group 02: Systems Condition.....	703
9.4.4.4	Group 03: Engine Control.....	705
9.4.4.5	Group 04: Applications Condition.....	707
9.4.4.6	Group 05: Engine Related Alarms.....	709
9.4.4.7	Group 06: Generator Related Alarms.....	710
9.4.4.8	Group 07: Mains Related Alarms.....	711
9.4.4.9	Group 08: System Related Alarms.....	712
9.4.4.10	Group 09: Discrete Inputs.....	713
9.4.4.11	Group 10: Analog Inputs.....	714
9.4.4.12	Group 11: Clock And Timer.....	714
9.4.4.13	Group 12: External Discrete Inputs 1.....	715
9.4.4.14	Group 13: Discrete Outputs.....	716
9.4.4.15	Group 14: External Discrete Outputs 1.....	716
9.4.4.16	Group 15: Flexible Limits.....	717
9.4.4.17	Group 17: Alarm System 2 (VDE-AR-N 4105 & Free Alarms).....	718
9.4.4.18	Group 18: Transistor Outputs.....	719
9.4.4.19	Group 22: External Discrete Inputs 2.....	720
9.4.4.20	Group 23: External Discrete Outputs 2.....	720
9.4.4.21	Group 24: Flags Condition 2.....	721
9.4.4.22	Group 25: Ext. Analog inputs.....	723
9.4.5	Factory Settings.....	723
9.5	Event And Alarm Reference.....	733
9.5.1	Alarm Classes.....	733
9.5.2	Conversion Factors.....	734
9.5.3	Status Messages.....	735
9.5.4	Event History.....	737
9.5.4.1	Event Messages.....	738
9.5.4.2	Alarm Messages.....	739
9.6	Formulas.....	747
9.6.1	Load Dependent Start Stop (LDSS) Formulas.....	747
9.7	Additional Information.....	749
9.7.1	D-SUB Connector Housing.....	749
9.7.2	CAN Bus Pin Assignments Of Third-Party Units.....	750
<b>10</b>	<b>Glossary And List Of Abbreviations.....</b>	<b>753</b>
<b>11</b>	<b>Index.....</b>	<b>755</b>



# 1 General Information

## 1.1 About This Manual

### 1.1.1 Revision History

Rev.	Date	Editor	Changes
F	2015-05-26	GG	<p><b>Describes software version 1.2109 and ToolKit version 4.7.3</b></p> <p>New features following BDEW requirements:</p> <ul style="list-style-type: none"> <li>■ Default Minimum values of parameter's 3004 ↪ p. 151 and 3010 ↪ p. 151 changed to 10%.</li> <li>■ Power factor characteristic PF(P) changed with two additional ramp points. Refer to: ↪ <i>Chapter 4.5.12.2 "Load Control" on page 308</i></li> <li>■ Q(V) monitoring takes into account both mains voltage and reactive voltage without using the minimum current, because this is only required for the consideration from voltage and phase angle. With this decision parameter 3287 [<i>Minimum Current</i>] is no longer available.</li> <li>■ Power factor Q(V) characteristic changed with two additional ramp points. Refer to: ↪ <i>Chapter 4.5.12.6.3.1 "Power factor characteristic PF(P)" on page 333</i></li> </ul> <p>Solving known problems:</p> <ul style="list-style-type: none"> <li>■ The Neutral Contactor (NC) feedback is considered in the event logger only if parameter 1840 ↪ p. 234 Neutral Interlocking is enabled. In this case both messages NC and DI12 appear. Otherwise the event logger shows DI12 messages only.</li> <li>■ Neutral Interlocking works in both AUTOMATIC and (new:) MANUAL mode to avoid missing NC connection. Refer to: ↪ <i>Chapter 4.5.1.11 "Neutral Interlocking" on page 234</i></li> <li>■ MANUAL mode only: After GCB synchronization and opening the MCB sometimes the GCB opened unexpectedly, too. This dead busbar situation now is eliminated.</li> <li>■ If genset is running and operation mode is changed from AUTOMATIC to MANUAL the 1PH3W voltage measuring now starts with the actual measured generator phase-phase voltage (L3L1) instead of L1N.</li> <li>■ Pressing the Remote Panel's STOP button is now correctly initializing unloading function, first. Refer to: ↪ <i>Chapter 4.5.12.9 "Discrete Raise/Low Function" on page 350</i></li> <li>■ The discrete raise/lower power setpoint function is no longer depending on MCB status. Now this setpoint function is available in isolated operation, too. Refer to: ↪ <i>Chapter 4.5.12.9 "Discrete Raise/Low Function" on page 350</i></li> <li>■ From this software version on the internal RAM is cleared before flashing with new data.</li> <li>■ Parameter source of voltage and frequency setpoints displayed in MANUAL mode came with AUTO mode parameters. MANUAL mode parameter sources are displayed now (values continue to be displayed correct).</li> <li>■ In run-up synchronization in conjunction with an undelayed closed GCB order, the dead busbar closure negotiation is now cancelled. This leads to a no-interrupted run-up procedure.</li> </ul> <p><b>Manual</b></p> <ul style="list-style-type: none"> <li>■ Updated according to the changes described above</li> <li>■ Derating/uprating of power described in more detail: Refer to ↪ <i>Chapter 4.5.12.3 "Derating (Uprating) Of Power" on page 315.</i></li> <li>■ Minor (typo) corrections</li> </ul>

Rev.	Date	Editor	Changes
E	2014-02-17	GG	<p><b>Describes software version 1.2102 and ToolKit version 4.4</b></p> <p><b>New device features &amp; updates:</b></p> <ul style="list-style-type: none"> <li>■ New Suspect Parameter Numbers (SPNs) available with J1939 Protocol: 2629, 3644, (0)158, 1761, 4367, and 4368. Refer to ↗ <i>“Standard visualization messages” on page 527</i> for details.</li> <li>■ GCB dead busbar closure is realized faster, if LogigsManager ID 12210 ↗ p. 228 “Undelayed close GCB” is set to TRUE. Refer to ↗ <i>“Dead Busbar Negotiation” on page 214</i> for details.</li> </ul> <p><b>ToolKit 4.4</b></p> <ul style="list-style-type: none"> <li>■ Updated for next version.</li> </ul> <p><b>Manual</b></p> <ul style="list-style-type: none"> <li>■ Updated according to the changes described above and minor typo/layout corrections.</li> <li>■ Parameter description corrected: 2104 ↗ p. 171, 3110 ↗ p. 141, 3315 ↗ p. 270, and 8856 ↗ p. 187.</li> <li>■ Parameter setting range corrected: 3504 ↗ p. 208, 3505 ↗ p. 209, 5743 ↗ p. 332, and 5744 ↗ p. 332.</li> <li>■ New description of faster GCB dead busbar closure. Refer to ↗ <i>“Dead Busbar Negotiation” on page 214</i> for details.</li> <li>■ Description of load sharing and segments optimized. Refer to ↗ <i>Chapter 4.5.12.7.8.1 “Load Share Control Grouping” on page 343</i> for details.</li> <li>■ Dimension/size of receive PDO objects corrected (bytes changed to bits). Refer to ↗ <i>Chapter 6.5.1.6 “Transmitting Multiple Setpoints” on page 490</i> for details.</li> <li>■ Minor (typo) corrections.</li> </ul>

Rev.	Date	Editor	Changes
D	2013-09-12	GG	<p><b>New device features &amp; updates with software version 1.2005</b></p> <ul style="list-style-type: none"> <li>■ The easYgen provides LogicsManager equations to release frequency control LM 00.96 and/or voltage control LM 00.97. The operator can now from outside determine when which control is executed. For details refer to: <ul style="list-style-type: none"> <li>– Release f-control parameter ID 12909 ↗ p. 308</li> <li>– Release V-control parameter ID 12938 ↗ p. 327</li> </ul> </li> <li>■ The easYgen provides a third active power setpoint, which can be switched like setpoint 1 and 2 from outside. Refer to Setp. 3load parameter ID 12998 ↗ p. 315 for details. (Beneficial, when demanded VDE-AR-N 4105).</li> <li>■ The reactive power controller additionally provides the reactive power regulation at the interchange point. Refer to ↗ <i>Chapter 4.5.12.6.1 "Control The Power Factor / Reactive Power At The Mains Interchange Point"</i> on page 328 for details.</li> <li>■ Load sharing: The ramping of an engine onto others will be interrupted if not enough nominal power on the busbar is available. Refer to ↗ <i>Chapter 4.5.12.7 "Load Share Control"</i> on page 336 for details.</li> <li>■ The easYgen provides a voltage restraint Time Over Current Relay (ANSI 51 V). Refer to ↗ <i>Chapter 4.4.1.17 "Generator Voltage Restrained Overcurrent Monitoring - ANSI #51"</i> on page 137</li> <li>■ The easYgen provides an external mains kvar sensing (via analog input). Refer to ↗ <i>Chapter 4.2.3 "External Mains Reactive Power"</i> on page 103 for details.</li> <li>■ The df/dt monitoring (ROCOF-Relay) is additionally applicable with Phase Shift Monitoring. Refer to ↗ <i>"Phase shift"</i> on page 159 for details.</li> <li>■ The QV monitoring function according the German grid code VDE-AR-N 4105 depends on the parameter "phase-phase/ phase-neutral monitoring" (Even if the grid code requires only phase/phase). Refer to ↗ <i>Chapter 4.4.2.9 "QV Monitoring"</i> on page 157 for details.</li> <li>■ A dedicated LogicsManager is installed to disable all mains monitoring and the decoupling function. The mains decoupling function can be released or blocked from outside now. Refer to ↗ <i>Chapter 4.4.2.16 "Blocking of Mains Protection"</i> on page 170 for details.</li> <li>■ The easYgen allows, under given circumstances, the external closure of GCB and MCB in synchronization mode "Off" being in AUTOMATIC. Refer to ↗ <i>Chapter 4.5.1.10 "Synchronization"</i> on page 232 for details.</li> <li>■ The easYgen synchronizer allows a negative slipping frequency at the interchange point for synchronization the MCB. This avoids in critical application exporting of power short after synchronization the MCB. Refer to ↗ <i>Chapter 4.5.1.9 "Breakers MCB"</i> on page 229 for details.</li> <li>■ The Neutral Interlocking feature controls a Neutral Contactor (NC) of each generator. The rule is that only one neutral contactor of all running generators are closed. The Logic must ensure that with changing of generators the neutral link is passed over to another running generator. Refer to ↗ <i>Chapter 4.5.1.11 "Neutral Interlocking"</i> on page 234 for details.</li> <li>■ The Generator monitoring can be blocked with a LogicsManager equation. This supports application, where the engine/generator monitoring shall be released or blocked from outside.</li> <li>■ The easYgen provides 4 configurable alarms with all related settings and free editable alarm texts. Refer to ↗ <i>Chapter 4.4.6.2 "Free Configurable Alarms"</i> on page 200 for details.</li> <li>■ The setting range for number of teeth of the Magnetic Pickup Unit is expanded. Refer to ↗ <i>Chapter 4.5.9.3 "Magnetic Pickup Unit"</i> on page 273 for details.</li> <li>■ The easYgen provides 8 dedicated thresholds out of the 40 flexible thresholds with an additionally configurable delay-off time. The flexible thresholds no. 25 through 32 are used. This feature ensures other functionalities, like for example load shedding. The individual fall-back times can be taken to generate 8 steps with individual priorities. Refer to ↗ <i>Chapter 4.4.5 "Flexible Limits"</i> on page 194 for details.</li> <li>■ The easYgen can automatically check, whether I/O expansion boards are connected. If not the easYgen disables accordingly functionalities, which are not needed and improves thereby the performance of HMI, Toolkit and Modbus.</li> </ul>

Rev.	Date	Editor	Changes
			<ul style="list-style-type: none"> <li>■ The remote control word 503 is equipped with the "Shut-Down-Command" (Bit 9). Refer to <a href="#">☞ "Bit enabling via Modbus protocol and RS-485 interface" on page 441</a> for details.</li> <li>■ The operating range monitor ( <a href="#">☞ Chapter 4.4.3.6 "Engine/Generator Unloading Mismatch" on page 177</a>) checks additionally the plausibility of generator and busbar, if GCB is closed.</li> <li>■ The Generator "Unload mismatch" monitor                         <ul style="list-style-type: none"> <li>– is usable in Application mode "None",</li> <li>– includes all alarm classes and a self reset feature.</li> </ul> </li> <li>■ The power factor monitoring is activated, if the generator current expires 5% rated Generator current. The monitoring shall be switched off, if the current under runs 3% rated Generator current. Refer to <a href="#">☞ Chapter 4.4.1.15 "Generator Lagging Power Factor (Level 1 &amp; 2)" on page 134</a> for details.</li> <li>■ A Time Indication is included to inform the operator, when the device will switch into a next operating condition, as long it is definable. The sequence of the events is related on the configuration of the device and the application. Refer to <a href="#">☞ Chapter 5.2.4.16 "Time Indication According To Operating Condition " on page 410</a>for details.</li> <li>■ The loading of settings files into the device can be accelerated, while being in STOP mode.</li> </ul> <p><b>ToolKit</b></p> <ul style="list-style-type: none"> <li>■ Pages with measurement values are faster refreshed.</li> <li>■ The wset-file procedure allows the editing and loading of partial setting files.</li> <li>■ The loading of settings files into the device can be accelerated, while being in STOP mode. Refer to <a href="#">☞ Chapter 4.1.5 "System Management" on page 92</a> for details.</li> </ul> <p><b>Manual</b></p> <ul style="list-style-type: none"> <li>■ More detailed explanation how it is dealt with the External Mains Active Power ( <a href="#">☞ Chapter 4.2.2 "External Mains Active Power" on page 102</a>).</li> <li>■ Descriptions of the new device features and updates listed above.</li> <li>■ Minor changes.</li> </ul>

Rev.	Date	Editor	Changes
C	2012-12-03	GG	<p><b>New device features &amp; updates with software version 1.2004</b></p> <ul style="list-style-type: none"> <li>■ The mains decoupling thresholds are displayed according to VDE-AR-N 4105. Refer to <a href="#">Chapter 5.2.4 "Specialised Menu Screens" on page 401</a> for details.</li> <li>■ A button (menu item) for testing the Decoupling Facility is included according to VDE-AR-N 4105. Refer to <a href="#">weitere Informationen on page 408</a> for details.</li> <li>■ The diagnostic to ensure the Single-failure-proof is included according to VDE-AR-N 4105. Refer to <a href="#">"Monitoring according AR-N-4105" on page 144</a> for details.</li> <li>■ The Droop Tracking can be disabled. Refer to <a href="#">"Droop related parameters" on page 347</a> for details.</li> <li>■ The load sharing can be disabled, when droop becomes active. Refer to <a href="#">"Load sharing in Droop mode On/Off" on page 347</a> for details.</li> <li>■ Mains Decoupling causes now Breaker Open alarm. Refer to <a href="#">Chapter 4.4.2.2 "Mains Decoupling" on page 140</a> for details.</li> <li>■ Changing from operating mode AUTO to MANUAL during droop is active holds the latest frequency and voltage setpoint.</li> </ul> <p><b>Corrections</b></p> <ul style="list-style-type: none"> <li>■ Two power factor characteristics are available for selection: <ul style="list-style-type: none"> <li>– The power factor in relation to the real power PF(P) or</li> <li>– the reactive power in relation to the mains voltage Q(V).</li> </ul> Refer to <a href="#">Chapter 4.5.12.6.3 "Power Factor Characteristic" on page 333</a> for details.</li> <li>■ Asynchron generator mode: Now the frequency 3-position controller considers the pickup speed regulation instead of the generator frequency. [CAC No. 50_0079]</li> </ul> <p><b>Manual</b></p> <ul style="list-style-type: none"> <li>■ New chapter explaining 'droop'. Refer to <a href="#">Chapter 4.5.12.7.9 "Droop" on page 345</a> for details.</li> <li>■ Changes caused by VDE-AR-N 4105 described/updated. Refer to <a href="#">Chapter 4.4.2.2.1 "Setup Grid Code AR-N-4105" on page 143</a> for details.</li> <li>■ New chapter explaining which functions are relevant to handle electrical energy sources running parallel to the medium voltage grid according to the German BDEW Grid Code. Refer to <a href="#">Chapter 4.4.2.2.2 "Setup Grid Code BDEW (medium voltage guideline)" on page 146</a> for details.</li> <li>■ The explanation how to control the LogicsManager via Modbus is reworked. Refer to <a href="#">Chapter 6.6.2.2 "Configuration Of LogicsManager Functions" on page 507</a> for details.</li> <li>■ Minor changes.</li> </ul>
B	2012-07-24	GG	<p><b>New device features &amp; updates</b></p> <ul style="list-style-type: none"> <li>■ New display unit language (parameter 1700): "Swedish". For details refer to 1700 <a href="#">p. 85</a>.</li> </ul> <p><b>Manual</b></p> <ul style="list-style-type: none"> <li>■ Minor corrections</li> </ul>

Rev.	Date	Editor	Changes
A	2012-03-12	TE	<p><b>Manual</b></p> <ul style="list-style-type: none"> <li>■ Minor corrections</li> </ul> <p><b>New device features &amp; updates</b></p> <p>Requirements: easYgen-3100/3200 genset control with software version 1.2002 or higher. The described changes relate to the previous software version 1.2001.</p> <p>Feature updates</p> <ul style="list-style-type: none"> <li>■ Mains voltage monitoring. Refer to <a href="#">Chapter 4.4.2 "Mains" on page 139</a> for details. The setting range of "Mains voltage monitoring" (parameter 1771 <a href="#">p. 139</a>) was extended to the entry "All".</li> <li>■ Mains time-dependent voltage monitoring. Refer to <a href="#">Chapter 4.4.2.8 "Mains Time-Dependent Voltage" on page 154</a> for details. The setting range of "Point 1 time" (parameter 4961 <a href="#">p. 156</a>) is configurable now.</li> </ul>
NEW	2011-09-14	TE	<p><b>Manual</b></p> <ul style="list-style-type: none"> <li>■ Release</li> </ul> <p><b>New device features &amp; updates</b></p> <p>Requirements: easYgen-3100/3200 genset control with software version 1.20xx or higher. The described changes relate to the previous software version 1.15xx.</p> <p>New features</p> <ul style="list-style-type: none"> <li>■ Phase angle compensation. Refer to <a href="#">Chapter 4.5.1.8 "Breakers GCB" on page 225</a> and <a href="#">Chapter 4.5.1.9 "Breakers MCB" on page 229</a> for details.</li> <li>■ Derating of power. Refer to <a href="#">Chapter 4.5.12.3 "Derating (Uprating) Of Power" on page 315</a> for details.</li> <li>■ Manual control of LogicsManager (GCB, MCB and Engine). Refer to <a href="#">Chapter 4.5.1.8 "Breakers GCB" on page 225</a>, <a href="#">Chapter 4.5.1.9 "Breakers MCB" on page 229</a> and <a href="#">Chapter 4.5.9.2 "Engine Start/Stop" on page 267</a> for details.</li> <li>■ Alarm class C &amp; E can be delayed in isolated operation. Refer to <a href="#">Chapter 4.5.11 "Automatic Run" on page 278</a> for details.</li> <li>■ QV monitoring. Refer to <a href="#">Chapter 4.4.2.9 "QV Monitoring" on page 157</a> for details.</li> <li>■ Mains time-dependent voltage monitoring. Refer to <a href="#">Chapter 4.4.2.8 "Mains Time-Dependent Voltage" on page 154</a> for details.</li> <li>■ Power factor characteristic. Refer to <a href="#">Chapter 4.5.12.6.3 "Power Factor Characteristic" on page 333</a> for details.</li> <li>■ Frequency depending derating of power. Refer to <a href="#">Chapter 4.5.12.4 "Frequency Depending Derating Of Power" on page 321</a> for details.</li> <li>■ Mains voltage increase monitoring. Refer to <a href="#">Chapter 4.4.2.7 "Mains Voltage Increase" on page 152</a> for details.</li> </ul> <p>Feature updates</p> <ul style="list-style-type: none"> <li>■ Remote control. Refer to <a href="#">Chapter 9.2.4 "Additional Data Identifier" on page 663</a> for details. "Remote control word 3" allows 16 independent interface command bits for free remote control.</li> <li>■ Support of MTU ADEC ECU8. Refer to <a href="#">Chapter 4.6.2.2 "J1939 Interface" on page 364</a> for details. The setting range of "Device type" (parameter 15102 <a href="#">p. 364</a>) was extended to the entry "ADEC ECU8 MTU".</li> <li>■ Mains undervoltage monitoring. Refer to <a href="#">Chapter 4.4.2.6 "Mains Undervoltage (Level 1 &amp; 2) ANSI# 27" on page 151</a> for details. The setting range of "Limit" (parameter 3004 <a href="#">p. 151</a> and 3010 <a href="#">p. 151</a>) has been lowered from 50% to 45%.</li> <li>■ Engine type. Refer to <a href="#">Chapter 4.5.9.1 "Engine Type" on page 260</a> for details. The setting range of "Start/stop mode logic" (parameter 3321 <a href="#">p. 260</a>) was extended to the entry "Off". This allows to completely disable the start/stop sequence.</li> </ul>

Rev.	Date	Editor	Changes
			<ul style="list-style-type: none"> <li>■ Change of frequency monitoring. Refer to <a href="#">Chapter 4.4.2.10 "Change Of Frequency" on page 159</a> for details. The setting range resolution of "Delay" (parameter 3105 <a href="#">p. 162</a>) has been changed from 0.1 s to 0.01 s.</li> <li>■ Configure counters. Refer to <a href="#">Chapter 4.8 "Configure Counters" on page 379</a> for details. The code level of parameter "Codelevel set operation hours" (parameter 2573 <a href="#">p. 381</a>) has been changed from level 5 to level 3.</li> <li>■ Configure language/clock. Refer to <a href="#">Chapter 4.1.1 "Configure Language/Clock" on page 85</a> for details. The setting range of "Language" (parameter 1700 <a href="#">p. 85</a>) was extended to the entry "Suomi". The easYgen now supports Finnish language.</li> <li>■ Analog Inputs. Refer to <a href="#">Chapter 4.5.2.1 "Analog Inputs" on page 235</a> for details. The parameters "Display temperature in" (parameter 3631 <a href="#">p. 235</a>) and "Display pressure in" (parameter 3630 <a href="#">p. 235</a>) now show the J1939 SPN values °C/°F respectively bar/psi in the device display.</li> <li>■ Mains undervoltage. Refer to <a href="#">Chapter 4.4.2.6 "Mains Undervoltage (Level 1 &amp; 2) ANSI# 27" on page 151</a> for details. The mains undervoltage 1 alarm can be linked to the mains decoupling function (parameter 8844 <a href="#">p. 152</a>).</li> <li>■ Mains overvoltage. Refer to <a href="#">Chapter 4.4.2.5 "Mains Overvoltage (Level 1 &amp; 2) ANSI# 59" on page 149</a> for details. The mains overvoltage 1 alarm can be linked to the mains decoupling function (parameter 8845 <a href="#">p. 151</a>).</li> </ul>

## 1.1.2 Depiction Of Notes And Instructions

### Safety instructions

Safety instructions are marked with symbols in these instructions. The safety instructions are always introduced by signal words that express the extent of the danger.



#### **DANGER!**

This combination of symbol and signal word indicates an immediately-dangerous situation that could cause death or severe injuries if not avoided.



#### **WARNING!**

This combination of symbol and signal word indicates a possibly-dangerous situation that could cause death or severe injuries if it is not avoided.



#### **CAUTION!**

This combination of symbol and signal word indicates a possibly-dangerous situation that could cause slight injuries if it is not avoided.



#### **NOTICE!**

This combination of symbol and signal word indicates a possibly-dangerous situation that could cause property and environmental damage if it is not avoided.

Tips and recommendations



*This symbol indicates useful tips and recommendations as well as information for efficient and trouble-free operation.*

Additional markings

To emphasize instructions, results, lists, references, and other elements, the following markings are used in these instructions:

Marking	Explanation
	Step-by-step instructions
	Results of action steps
	References to sections of these instructions and to other relevant documents
	Listing without fixed sequence
<i>[Buttons]</i>	Operating elements (e.g. buttons, switches), display elements (e.g. signal lamps)
<i>"Display"</i>	Screen elements (e.g. buttons, programming of function keys)

## 1.2 Copyright And Disclaimer

### Disclaimer

All information and instructions in this manual have been provided under due consideration of applicable guidelines and regulations, the current and known state of the art, as well as our many years of in-house experience. Woodward GmbH assumes no liability for damages due to:

- Failure to comply with the instructions in this manual
- Improper use / misuse
- Willful operation by non-authorized persons
- Unauthorized conversions or non-approved technical modifications
- Use of non-approved spare parts

The originator is solely liable to the full extent for damages caused by such conduct. The agreed upon obligations in the delivery contract, the general terms and conditions, the manufacturer's delivery conditions, and the statutory regulations valid at the time the contract was concluded, apply.

### Copyright

This manual is protected by copyright. No part of this manual may be reproduced in any form or incorporated into any information retrieval system without written permission of Woodward GmbH.

Delivery of this manual to third parties, duplication in any form - including excerpts - as well as exploitation and/or communication of the content, are not permitted without a written declaration of release by Woodward GmbH.



Actions to the contrary exact damage compensation. We reserve the right to enforce additional claims.

## 1.3 Service And Warranty

Our Customer Service is available for technical information. Please see page 2 for the contact data.

In addition, our employees are constantly interested in new information and experiences that arise from usage and could be valuable for the improvement of our products.

### Warranty terms



*Please enquire about the terms of warranty from your nearest Woodward representative.*

*For our contact search webpage please go to:  
<http://www.woodward.com/Directory.aspx>*

## 1.4 Safety

### 1.4.1 Intended Use

The genset control unit has been designed and constructed solely for the intended use described in this manual.

The genset control unit must be used exclusively for engine-generator system management applications.

- Intended use requires operation of the control unit within the specifications listed in *Chapter 8.1 "Technical Data" on page 543*.
- All permissible applications are outlined in *Chapter 6 "Application" on page 417*.
- Intended use also includes compliance with all instructions and safety notes presented in this manual.
- Any use which exceeds or differs from the intended use shall be considered improper use.
- No claims of any kind for damage will be entertained if such claims result from improper use.



#### **NOTICE!**

##### **Damage due to improper use!**

Improper use of the genset control unit may cause damage to the control unit as well as connected components.

Improper use includes, but is not limited to:

- Operation outside the specified operation conditions.

## 1.4.2 Personnel



**WARNING!**

**Hazards due to insufficiently qualified personnel!**

If unqualified personnel perform work on or with the control unit hazards may arise which can cause serious injury and substantial damage to property.

- Therefore, all work must only be carried out by appropriately qualified personnel.

This manual specifies the personnel qualifications required for the different areas of work, listed below:

- Well trained for electrical installations.
- Skilled and competent to be aware especially of the local safety regulations.
- Experienced in working on electronic measuring and control devices.
- Allowed to manage the controlled (engine/generator) system.

The workforce must only consist of persons who can be expected to carry out their work reliably. Persons with impaired reactions due to, for example, the consumption of drugs, alcohol, or medication are prohibited.

When selecting personnel, the age-related and occupation-related regulations governing the usage location must be observed.

### 1.4.3 General Safety Notes

#### Electrical hazards



#### **DANGER!**

#### **Life-threatening hazard from electric shock!**

There is an imminent life-threatening hazard from electric shocks from live parts. Damage to insulation or to specific components can pose a life-threatening hazard.

- Only a qualified electrician should perform work on the electrical equipment.
- Immediately switch off the power supply and have it repaired if there is damage to the insulation.
- Before beginning work at live parts of electrical systems and resources, cut the electricity and ensure it remains off for the duration of the work. Comply with the five safety rules in the process:
  - cut electricity;
  - safeguard against restart;
  - ensure electricity is not flowing;
  - earth and short-circuit; and
  - cover or shield neighboring live parts.
- Never bypass fuses or render them inoperable. Always use the correct amperage when changing fuses.
- Keep moisture away from live parts. Moisture can cause short circuits.

#### Prime mover safety



#### **WARNING!**

#### **Hazards due to insufficient prime mover protection**

The engine, turbine, or other type of prime mover should be equipped with an overspeed (over-temperature, or over-pressure, where applicable) shutdown device(s), that operates totally independently of the prime mover control device(s) to protect against runaway or damage to the engine, turbine, or other type of prime mover with possible personal injury or loss of life should the mechanical-hydraulic governor(s) or electric control(s), the actuator(s), fuel control(s), the driving mechanism(s), the linkage(s), or the controlled device(s) fail.

#### Device implemented self test

this Woodward device has a self test check implemented. Permanently under control are:

- processor function and
- supply voltage.

This internal signal "self check" is aligned in series with the inverse signal "Ready for op. OFF" parameter 12580 ↵ p. 252/↵ p. 253. Per default (factory settings) discrete output R01 is energized/closed if device itself is OK.

LM equation 00.41 allows to customize this safety relay by changing conditions for LM command variable 12580.



*Be careful in changing safety relevant settings!*



### **CAUTION!**

#### **Uncontrolled operation due to faulty configuration**

The discrete output "Ready for operation OFF" must be wired in series with an emergency stop function.

This means that it must be ensured that the generator circuit breaker is opened and the engine is stopped if this discrete output is de-energized.

If the availability of the plant is important, this fault must be signaled independently from the unit.

## Modifications



### **WARNING!**

#### **Hazards due to unauthorized modifications**

Any unauthorized modifications to or use of this equipment outside its specified mechanical, electrical, or other operating limits may cause personal injury and/or property damage, including damage to the equipment.

Any unauthorized modifications:

- constitute "misuse" and/or "negligence" within the meaning of the product warranty thereby excluding warranty coverage for any resulting damage
- invalidate product certifications or listings.

## Use of batteries/alternators



### **NOTICE!**

#### **Damage to the control system due to improper handling**

Disconnecting a battery from a control system that uses an alternator or battery-charging device whilst the charging device is still connected causes damage to the control system.

- Make sure the charging device is turned off before disconnecting the battery from the system.

## Electrostatic discharge

Protective equipment: ■ ESD wrist band



### NOTICE!

#### Damage from electrostatic discharge

All electronic equipment sensitive to damage from electrostatic discharge, which can cause the control unit to malfunction or fail.

- To protect electronic components from static damage, take the precautions listed below.



1. Avoid build-up of static electricity on your body by not wearing clothing made of synthetic materials. Wear cotton or cotton-blend materials as much as possible because these do not store static electric charges as easily as synthetics.
2. Before any maintenance work on the control unit, ground yourself by touching and holding a grounded metal object (pipes, cabinets, equipment, etc.) to discharge any static electricity.  
Alternatively wear an ESD wrist band connected to ground.
3. Keep plastic, vinyl, and Styrofoam materials (such as plastic or Styrofoam cups, cigarette packages, cellophane wrappers, vinyl books or folders, plastic bottles, etc.) away from the control unit, modules and work area.
4. Opening the control cover may void the unit warranty. Do not remove the printed circuit board (PCB) from the control cabinet unless instructed by this manual.



*If instructed by this manual to remove the PCB from the control cabinet, follow these precautions:*

- *Ensure that the device is completely voltage-free (all connectors have to be disconnected).*
- *Do not touch any part of the PCB except the edges.*
- *Do not touch the electrical conductors, connectors, or components with conductive devices or with bare hands.*
- *When replacing a PCB, keep the new PCB in the plastic antistatic protective bag it comes in until you are ready to install it. Immediately after removing the old PCB from the control cabinet, place it in the antistatic protective bag.*



*For additional information on how to prevent damage to electronic components caused by improper handling, read and observe the precautions in:*

- *"Woodward manual 82715, Guide for Handling and Protection of Electronic Controls, Printed Circuit Boards, and Modules".*

### Notes on marine usage

Marine usage of the easYgen genset control requires additional precautions as listed below:



*The specified marine approvals are initially only valid for metal housing units. They are only valid for plastic housing units, if they are installed using the screw kit .*

- *Use all 12 screws and tighten accordingly.*

- The easYgen-3000(XT) Series has an internally isolated power supply.



#### **NOTICE!**

#### **Malfunctions due to insufficient protection against electromagnetic interference**

Exposure to increased electromagnetic interference on bridge and deck zones may cause malfunctions or incorrect internal readings.

- Install an EMI filter (i.e. TIMONTA FSS2-65-4/3) for the power supply inputs when using the control unit on bridge and deck zones.



*Some additional, independent safety and protection devices are necessary to meet safety requirements of Rules and Regulations of marine Classification Societies.*

- *Please refer to the corresponding documents issued by marine Classification Societies for the applicable requirements.*



*The easYgen is type approved by LR Lloyd's Register.*

- *Please consider for final functional arrangements to comply with appropriate Lloyd's Register Rules as subject of the Plan Approval process.*

## 1.4.4 Protective Equipment And Tools

### Protective gear

Personal protective equipment serves to protect risks to the safety and health of persons as well as to protect delicate components during work.

Certain tasks presented in this manual require the personnel to wear protective equipment. Specific required equipment is listed in each individual set of instructions.

The cumulative required personal protective equipment is detailed below:

**ESD wrist band**

The ESD (electrostatic discharge) wrist band keeps the user's body set to ground potential. This measure protects sensitive electronic components from damage due to electrostatic discharge.

**Tools**

Use of the proper tools ensures successful and safe execution of tasks presented in this manual.

Specific required tools are listed in each individual set of instructions.

The cumulative required tools are detailed below:

**Torque screwdriver**

A torque-screwdriver allow fastening of screws to a precisely specified torque.

- Note the required torque range individually specified in the tasks listed in this manual.

## General Information

---

Safety > Protective Equipment And T...



## 2 System Overview

This chapter provides a basic overview of the genset control unit.

Refer to the comprehensive chapters indicated below to commission the control unit:

- [Chapter 3 “Installation” on page 37](#) provides information on how to mount the unit and setup connections.
- [Chapter 4 “Configuration” on page 85](#) provides information on basic setup and reference information on all configurable parameters.
- [Chapter 5 “Operation” on page 383](#) provides information on how to access the unit via the front panel or remotely using the ToolKit software provided by Woodward.
- [Chapter 6 “Application” on page 417](#) provides application examples as well as instructions for the corresponding required configuration.
- [Chapter 7 “Interfaces And Protocols” on page 521](#) provides reference information on the usage of the interfaces and protocols provided by the control unit.

### 2.1 Display And Status Indicators

#### easYgen-3200 display



Fig. 4: Display

The display ( Fig. 4) as part of the easYgen-3200 is used for direct access to status information and configuration.



For information on the usage of the graphical user interface refer to [Chapter 5.2 “Front Panel Access” on page 392](#).

The easYgen-3100 is not equipped with a display and requires remote access for configuration ( [Chapter 5.1 “Access Via PC \(ToolKit\)” on page 383](#)).

#### easYgen-3100 LEDs

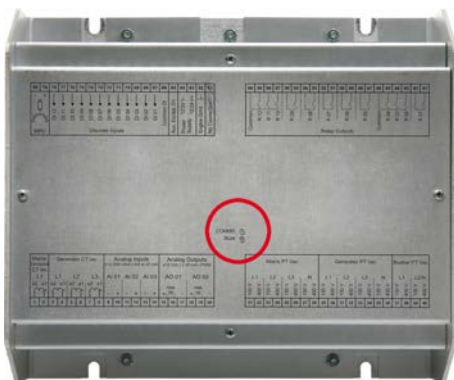

Fig. 5: Position of LEDs

The easYgen-3100 unit with metal housing and without display and buttons features two LEDs ( Fig. 5) on the front plate.

The two LEDs indicate the following states:

State	Indication
NOT illuminated	No data is received by any interface.
Blinking green	Data is received by any interface.
Illuminated red	The number of participants on the load share bus does not match with the configuration.
Blinking green/red	The number of participants on the load share bus does not match with the configuration and data is received by any interface.

Table 1: COMMS LED





State	Indication
 NOT illuminated	The unit is not ready for operation.
 Illuminated green	The unit is ready for operation and no alarm is present.
 Blinking green/red	The unit is ready for operation, but a warning alarm (alarm class A or B) is present.
 Illuminated red	The unit is ready for operation, but a shutdown alarm (alarm class C, D, E or F) is present.

Table 2: RUN LED



**Definition**

An alarm is "present" when it is active or latched (triggered).

**2.2 Hardware Interfaces (Terminals)**

The easYgen-3100/3200 ( Fig. 6) provides the following terminals.

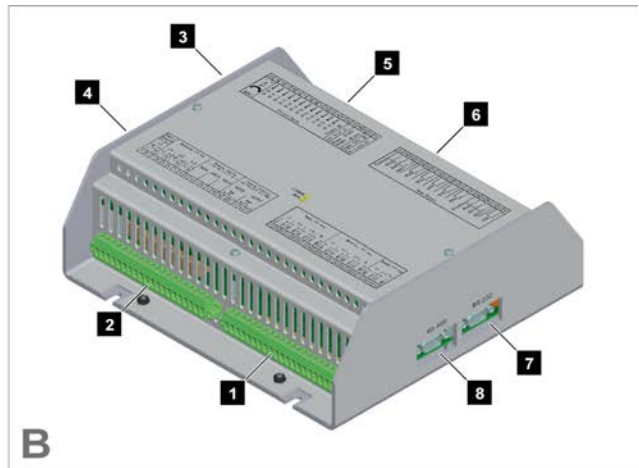
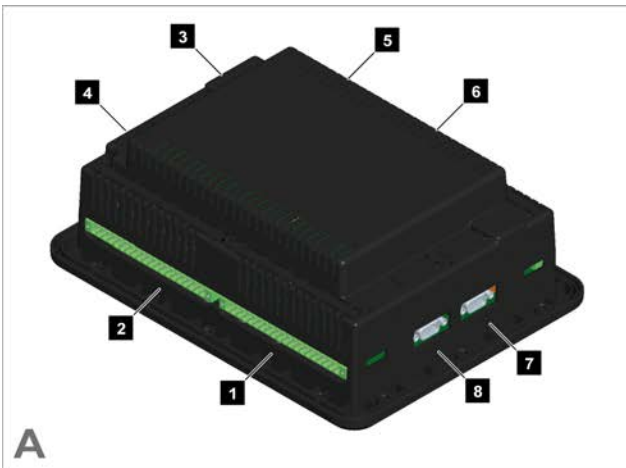

Fig. 6: easYgen-3000 Series (housing variants)

- A easYgen-3200 (plastic housing with display)
- B easYgen-3100 (sheet metal housing)
- 1 Mains/generator/busbar PT terminal
- 2 Analog inputs/outputs and generator CT terminal
- 3 CAN bus interface connector #1

- 4 CAN bus interface connector #2
- 5 Discret inputs terminal
- 6 Relay outputs terminal
- 7 RS-232 interface connector
- 8 RS-485 interface connector



For information on how to setup connections refer to [Chapter 3.3 "Setup Connections"](#) on page 42.

For information on the interfaces and protocols refer to [Chapter 7 "Interfaces And Protocols"](#) on page 521.

## 2.3 Application Modes Overview

The genset control provides the following basic functions via the application modes listed below.



*For detailed information on the application modes and special applications refer to [Chapter 6 “Application”](#) on page 417.*

Application mode	Symbol	Function
None	<b>A01</b>	<p>No breaker control.</p> <p>This application mode provides the following functions:</p> <ul style="list-style-type: none"> <li>■ Measuring of engine/generator parameters (i.e. voltage, frequency, current, power, coolant temperature, oil pressure, etc.)</li> <li>■ Engine start/stop</li> </ul>
GCBopen	<b>A02</b>	<p>GCB control (open)</p> <p>This application mode provides the following functions:</p> <ul style="list-style-type: none"> <li>■ Measuring of engine/generator parameters (i.e. voltage, frequency, current, power, coolant temperature, oil pressure, etc.)</li> <li>■ Engine start/stop</li> <li>■ Engine/generator protection (relay output to open GCB)</li> <li>■ Mains failure detection with mains decoupling (GCB)</li> </ul>
GCB	<b>A03</b>	<p>GCB control (open/close)</p> <p>This application mode provides the following functions:</p> <ul style="list-style-type: none"> <li>■ Measuring of engine/generator parameters (i.e. voltage, frequency, current, power, coolant temperature, oil pressure, etc.)</li> <li>■ Engine start/stop</li> <li>■ Engine/generator protection (relay output to open GCB)</li> <li>■ GCB operation (relay output to close GCB)</li> <li>■ Mains failure detection with mains decoupling (GCB)</li> </ul>
GCB/MCB	<b>A04</b>	<p>GCB/MCB control (open/close)</p> <p>This application mode provides the following functions:</p> <ul style="list-style-type: none"> <li>■ Measuring of engine/generator parameters (i.e. voltage, frequency, current, power, coolant temperature, oil pressure, etc.)</li> <li>■ Engine start/stop</li> <li>■ Engine/generator protection (relay output to open GCB)</li> <li>■ GCB operation (relay output to close GCB)</li> <li>■ MCB operation (relay outputs to open and close MCB)</li> <li>■ Mains failure detection with mains decoupling (GCB and/or MCB)</li> <li>■ Auto mains failure operation (AMF)</li> </ul>



### 3 Installation

#### 3.1 Mount Unit (Sheet Metal Housing)

##### Dimensions

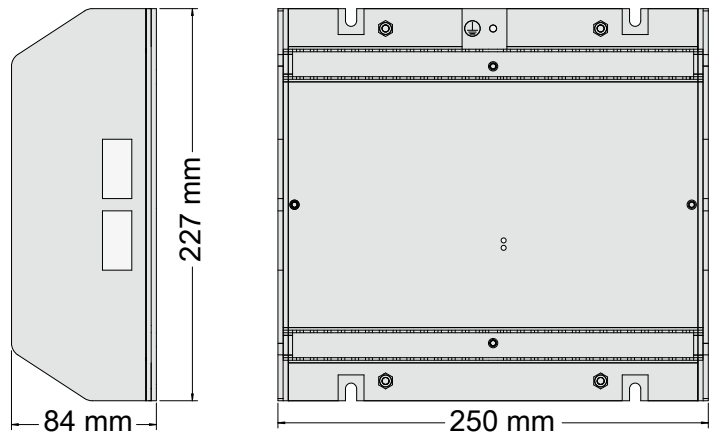

*Fig. 7: Sheet metal housing - dimensions*

Mounting into a cabinet

Special tool: ■ Torque screwdriver

Proceed as follows to install the unit using the screw kit:

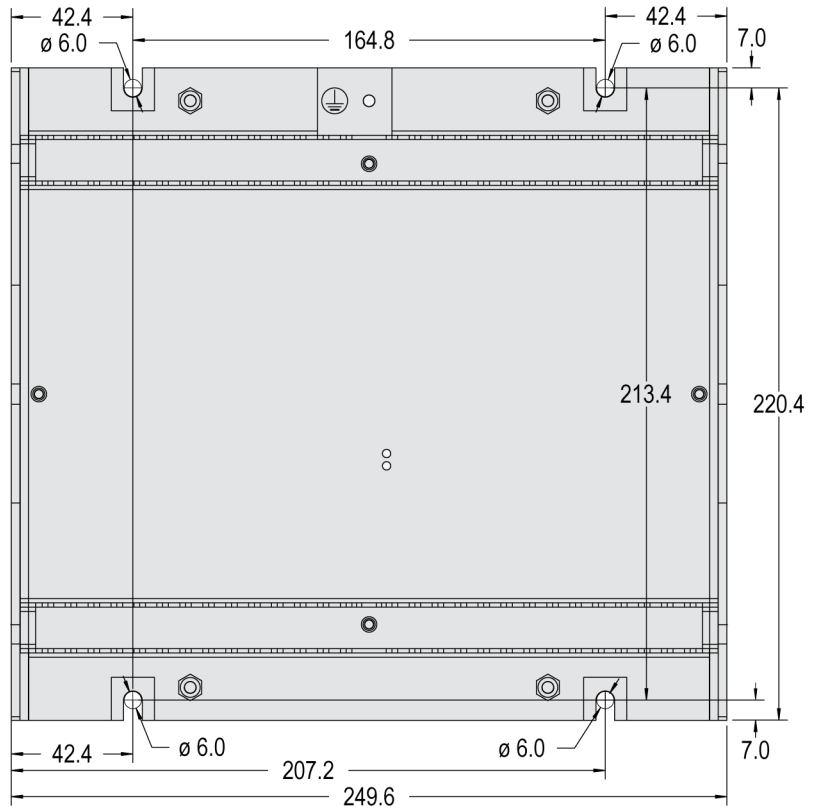

Fig. 8: Sheet metal housing - drill plan

1. ▶ Drill the holes according to the dimensions in Fig. 8 (dimensions shown in mm).

**i** Ensure sufficient clearance for access to the terminals (top and bottom) and connectors located at the sides.

2. ▶ Mount the unit to the back panel and insert the screws.
3. ▶ Tighten the screws to a torque according to the quality class of the used screws.

**i** Tighten the screws with a crosswise pattern to ensure even pressure distribution.

**i** If the thickness of the panel sheet exceeds 2.5 mm, be sure to use screws with a length exceeding the panel sheet thickness by 4 mm.

### 3.2 Mount Unit (Plastic Housing)

Mount the unit **either** using the clamp fasteners (☞ Chapter 3.2.1 “Clamp Fastener Installation” on page 40) **or** the screw kit (☞ Chapter 3.2.2 “Screw Kit Installation” on page 41).

**i**

- Don't drill holes if you want to use the clamp fasteners. If the holes are drilled into the panel, the clamp fasteners cannot be used anymore.
- In order to enhance the protection to IP 66, fasten the unit with the screw kit instead of the clamp fastener hardware.

#### Dimensions

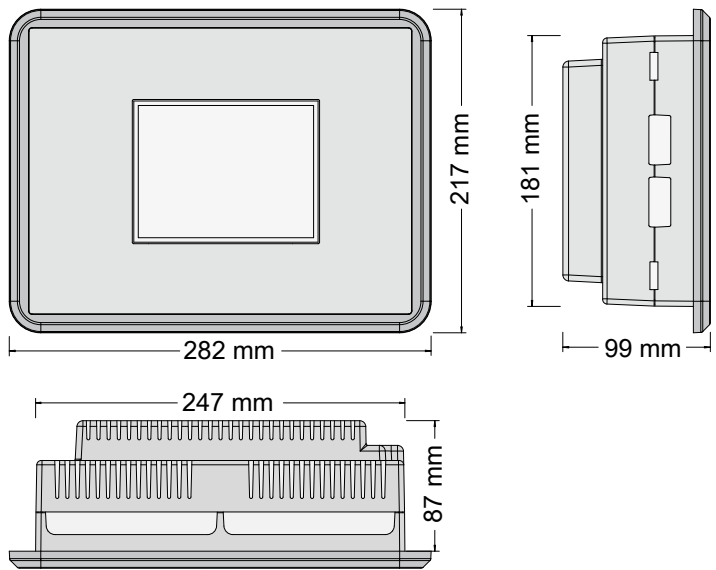

Fig. 9: Plastic housing - dimensions

#### Panel cutout

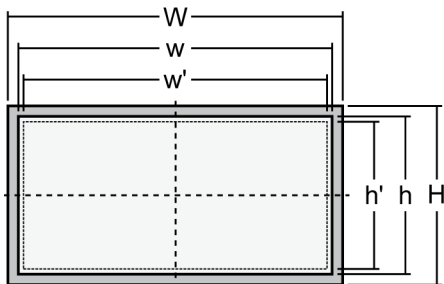

Fig. 10: Cutout schematic

Measure	Description			Tolerance
H	Height	Total	217 mm	---
		Panel cutout	183 mm	+ 1.0 mm
		Housing dimension	181 mm	
W	Width	Total	282 mm	---
		Panel cutout	249 mm	+ 1.1 mm
		Housing dimension	247 mm	
	Depth	Total	99 mm	---



*The maximum permissible corner radius is 4 mm.*

### 3.2.1 Clamp Fastener Installation

For installation into a door panel with the fastening clamps, proceed as follows:

1. ➤ Cut out the panel according to the dimensions in Fig. 10.



*Don't drill the holes if you want to use the clamp fasteners. If the holes are drilled into the panel, the clamp fasteners cannot be used anymore!*

2. ➤ Loosen the wire connection terminal screws on the back of the unit and remove the wire connection terminal strip if required.

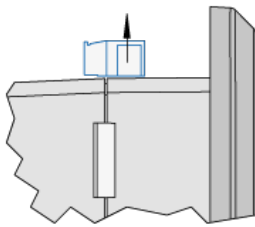
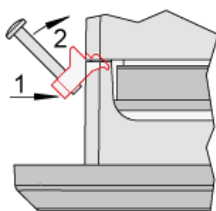

*Fig. 11: Remove terminals*



3. ➤ Insert the four clamping screws into the clamp inserts from the shown side ( Fig. 12; opposite the nut insert) until they are almost flush. Do not completely insert the screws into the clamp inserts.
4. ➤ Insert the unit into the panel cutout. Verify that the unit fits correctly in the cutout. If the panel cutout is not big enough, enlarge it accordingly.

*Fig. 12: Insert screws in clamps*



5. ➤ Re-install the clamp inserts by tilting the insert to a 45° angle. ( Fig. 13/1) Insert the nose of the insert into the slot on the side of the housing. ( Fig. 13/2) Raise the clamp insert so that it is parallel to the control panel.

*Fig. 13: Attach clamp inserts*







Special tool: ■ Torque screwdriver

Proceed as follows to install the unit using the screw kit:

1. ➤ Cut out the panel and drill the holes according to the dimensions in Fig. 16 (dimensions shown in mm).
2. ➤ Insert the unit into the panel cutout. Verify that the unit fits correctly in the cutout. If the panel cutout is not big enough, enlarge it accordingly.
3. ➤ Insert the screws and tighten to 0.6 Nm (5.3 pound inches) of torque.

 *Tighten the screws with a crosswise pattern to ensure even pressure distribution.*

 *If the thickness of the panel sheet exceeds 2.5 mm, be sure to use screws with a length exceeding the panel sheet thickness by 4 mm.*

### 3.3 Setup Connections

#### General notes

 **NOTICE!**  
**Malfunctions due to literal use of example values**  
 All technical data and ratings indicated in this chapter are merely listed as examples. Literal use of these values does not take into account all actual specifications of the control unit as delivered.

- For definite values please refer to chapter [↪ Chapter 8.1 “Technical Data” on page 543.](#)

#### Wire sizes

AWG	mm <sup>2</sup>	AWG	mm <sup>2</sup>	AWG	mm <sup>2</sup>	AWG	mm <sup>2</sup>	AWG	mm <sup>2</sup>	AWG	mm <sup>2</sup>
30	0.05	21	0.38	14	2.5	4	25	3/0	95	600MCM	300
28	0.08	20	0.5	12	4	2	35	4/0	120	750MCM	400
26	0.14	18	0.75	10	6	1	50	300MCM	150	1000MCM	500
24	0.25	17	1.0	8	10	1/0	55	350MCM	185		
22	0.34	16	1.5	6	16	2/0	70	500MCM	240		

Table 3: Conversion chart - wire sizes

#### 3.3.1 Terminal Allocation

The device terminals are allocated as follows:

- Plastic housing - for easYgen-3200
- Sheet metal housing - for easYgen-3100

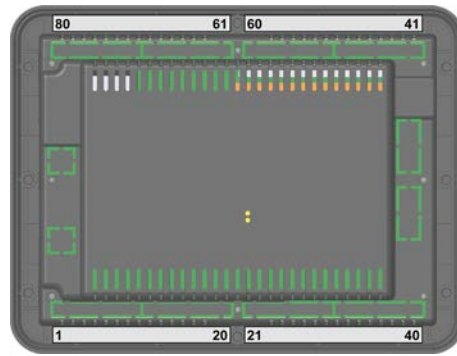

Fig. 17: easYgen-3200 plastic housing

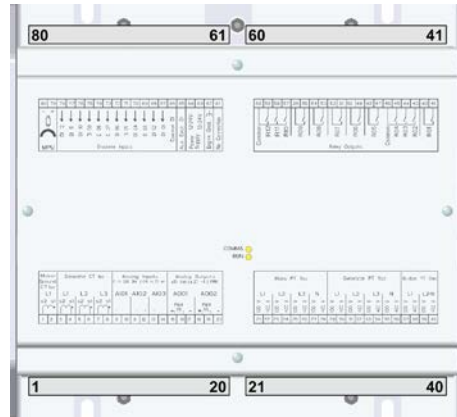

Fig. 18: easYgen-3100 sheet metal housing

### 3.3.2 Wiring Diagram



The Protective Earth terminal 61 is not connected on the sheet metal housing.

- Use the protective earth (PE) connector located at the bottom center of the sheet metal housing instead.

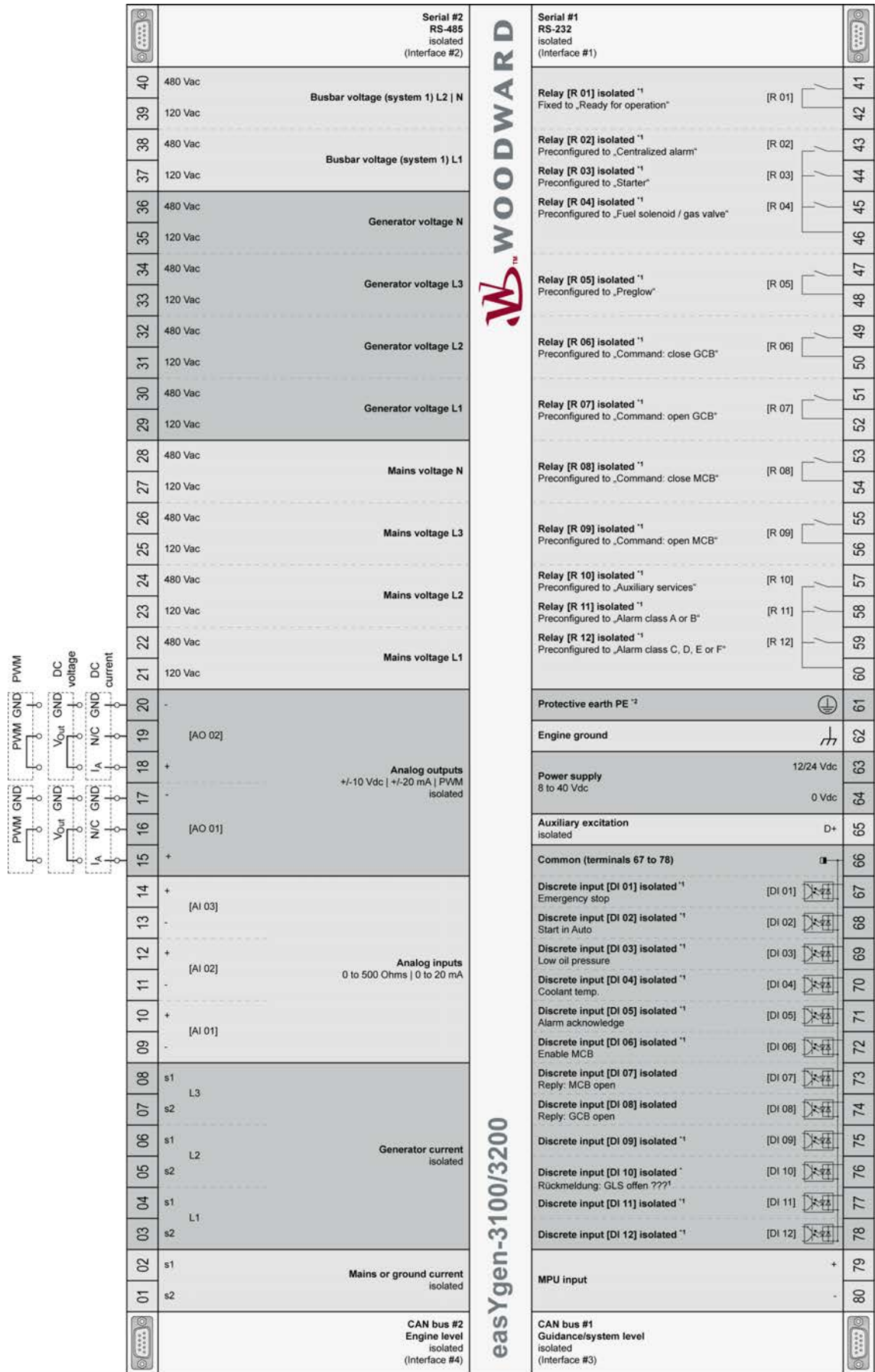

Subject to technical modifications.

\* = configurable via LogicManager \*\* = only available in easYgen-3200

easYgen-3100/3200 Wiring Diagram | Rev. F

Fig. 19: Wiring diagram

### 3.3.3 Power Supply

#### General notes



#### WARNING!

##### Risk of electric shock - plastic housing

- Connect Protective Earth (PE) to the unit to avoid the risk of electric shock. Setup the connection using screw-plug-terminal 61.
- The conductor providing the connection must have a wire larger than or equal to 2.5 mm<sup>2</sup> (14 AWG). The connection must be performed properly.



#### WARNING!

##### Risk of electric shock - sheet metal housing

- Connect Protective Earth (PE) to the unit to avoid the risk of electric shock. Use the protective earth (PE) connector located at the bottom center of the sheet metal housing.
- The conductor providing the connection must have a wire larger than or equal to 2.5 mm<sup>2</sup> (14 AWG). The connection must be performed properly.



#### WARNING!

##### Permissible differential voltage

The maximum permissible differential voltage between terminal 64 (B-) and terminal 61 (PE) is 40 V. On engines where a direct connection between battery minus and PE is not possible, it is recommended to use an isolated external power supply if the differential voltage between battery minus and PE exceeds 40 V.



*Woodward recommends to use one of the following slow-acting protective devices in the supply line to terminal 63:*

- Fuse NEOZED D01 6A or equivalent **or**
- Miniature Circuit Breaker 6A / Type C  
(for example: ABB type: S271C6 or equivalent)

#### Schematic and terminals

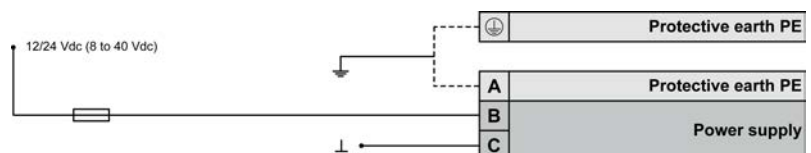

Fig. 20: Power supply - wiring

Terminal	Description	A <sub>max</sub>
A	61 PE (protective earth) - plastic housing ONLY	2.5 mm <sup>2</sup>
B	63 12/24Vdc (8 to 40.0 Vdc)	2.5 mm <sup>2</sup>
C	64 0 Vdc	2.5 mm <sup>2</sup>

Table 4: Power supply - terminal assignment

Characteristics

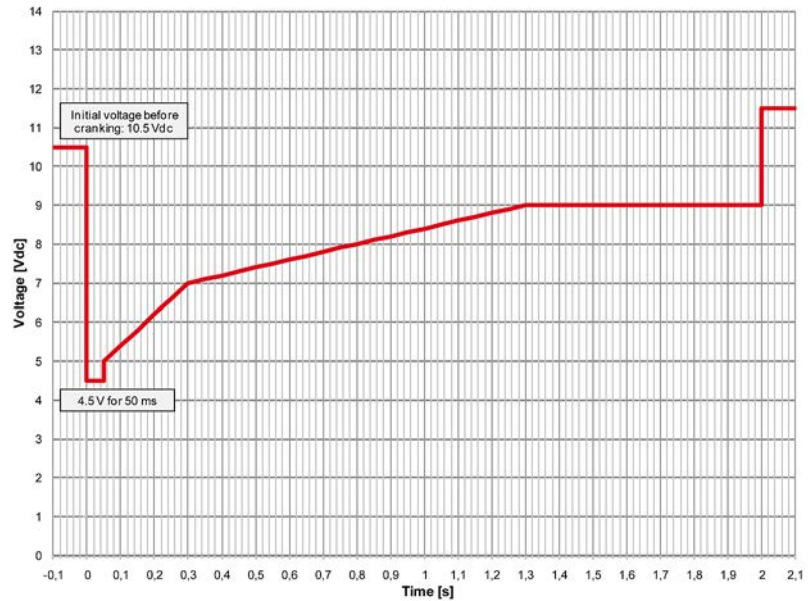

Fig. 21: Power supply - crank waveform

3.3.4 Charging Alternator

General notes



The charging alternator D+ acts as an pre-exciting output during the engine start-up.

During regular operation, it acts as an input for monitoring the charging voltage.

Schematic and terminals

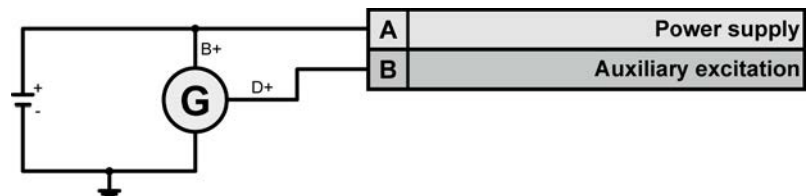

Fig. 22: Charging alternator - wiring

Terminal	Description	A <sub>max</sub>	
A	63	Battery B+ (8 to 40.0 Vdc)	2.5 mm <sup>2</sup>
B	65	Auxiliary excitation (D+) output	2.5 mm <sup>2</sup>

Table 5: Charging alternator - terminal assignment

### 3.3.5 Voltage Measuring

#### General notes



**NOTICE!**

**Incorrect readings due to improper setup**

The control unit will not measure voltage correctly if the 120 V and 480 V inputs are utilized simultaneously.

- Never use both sets of voltage measuring inputs.



Woodward recommends protecting the voltage measuring inputs with slow-acting fuses rated for 2 to 6 A.

#### 3.3.5.1 Generator Voltage

#### General notes



If parameter 1800 ↪ p. 99 ("Gen. PT secondary rated volt.") is configured with a value between 50 and 130 V, the 120 V input terminals must be used for proper measurement.

If parameter 1800 ↪ p. 99 ("Gen. PT secondary rated volt.") is configured with a value between 131 and 480 V, the 480 V input terminals must be used for proper measurement.

#### Schematic and terminals

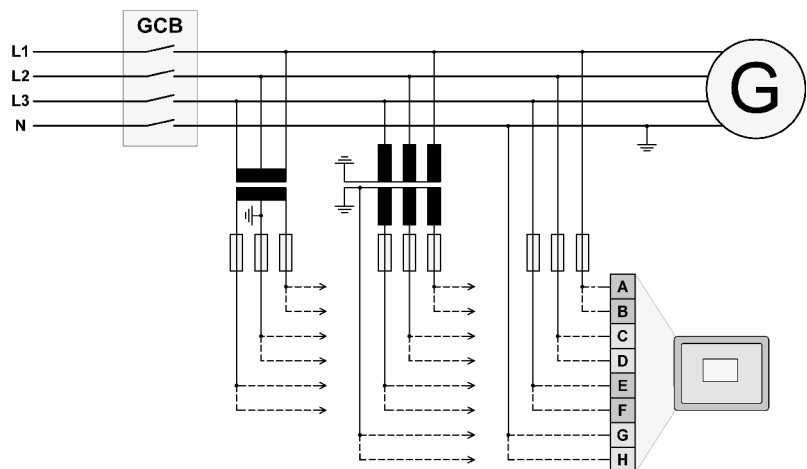

Fig. 23: Voltage measuring - generator - wiring

Terminal		Description		A <sub>max</sub>
A	29	Generator voltage - L1	120 Vac	2.5 mm <sup>2</sup>
B	30		480 Vac	2.5 mm <sup>2</sup>
C	31	Generator voltage - L2	120 Vac	2.5 mm <sup>2</sup>
D	32		480 Vac	2.5 mm <sup>2</sup>
E	33	Generator voltage - L3	120 Vac	2.5 mm <sup>2</sup>
F	34		480 Vac	2.5 mm <sup>2</sup>
G	35	Generator voltage - N	120 Vac	2.5 mm <sup>2</sup>
H	36		480 Vac	2.5 mm <sup>2</sup>

Table 6: Voltage measuring - generator - terminal assignment

3.3.5.1.1 Parameter Setting '3Ph 4W OD' (3-phase, 4-wire, Open delta)

Generator windings

A generator system that is connected to the load through a 3-phase, 4-wire connection but have the device wired for a 3-phase, 3-wire installation may have the L2 phase grounded on the secondary side. In this application the device will be configured for 3-phase, 4-wire OD for correct power measurement.

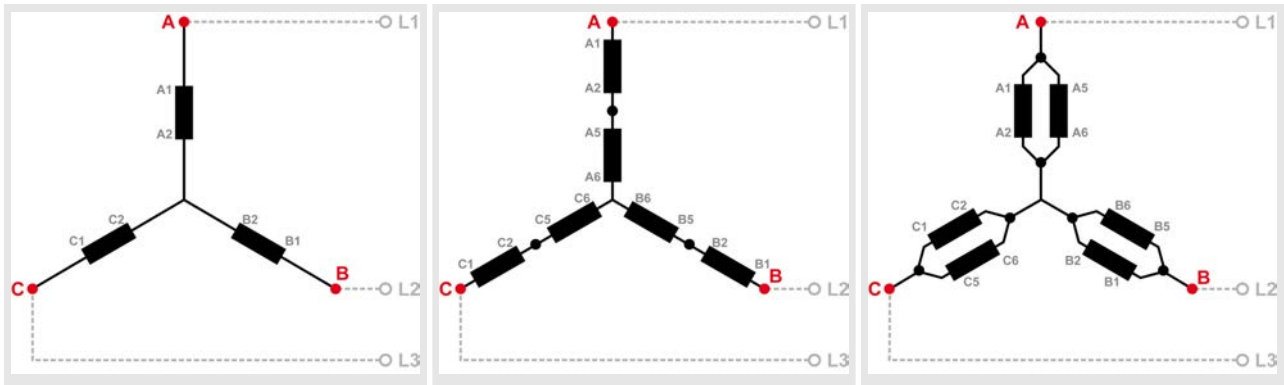

Table 7: Generator windings - 3Ph 4W OD



Measuring inputs

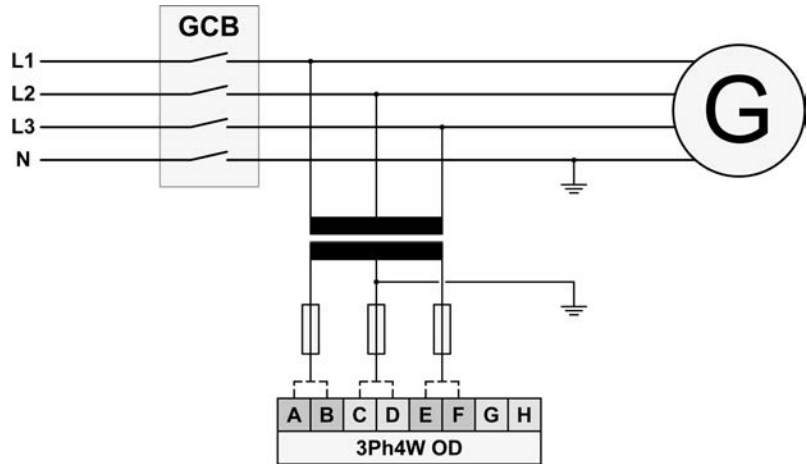

Fig. 24: Measuring inputs - 3Ph 4W OD

Terminal assignment

3Ph 4W OD	Wiring terminals							
Rated voltage (range)	120 V (50 to 130 V <sub>eff.</sub> )				480 V (131 to 480 V <sub>eff.</sub> )			
Measuring range (max.)	0 to 150 Vac				0 to 600 Vac			
Terminal	A	C	E	G	B	D	F	H
	29	31	33	35	30	32	34	36
Phase	L1	L2	L3	—	L1	L2	L3	—



For different voltage systems, different wiring terminals have to be used.

3.3.5.1.2 Parameter Setting '3Ph 4W' (3-phase, 4-wire)

Generator windings

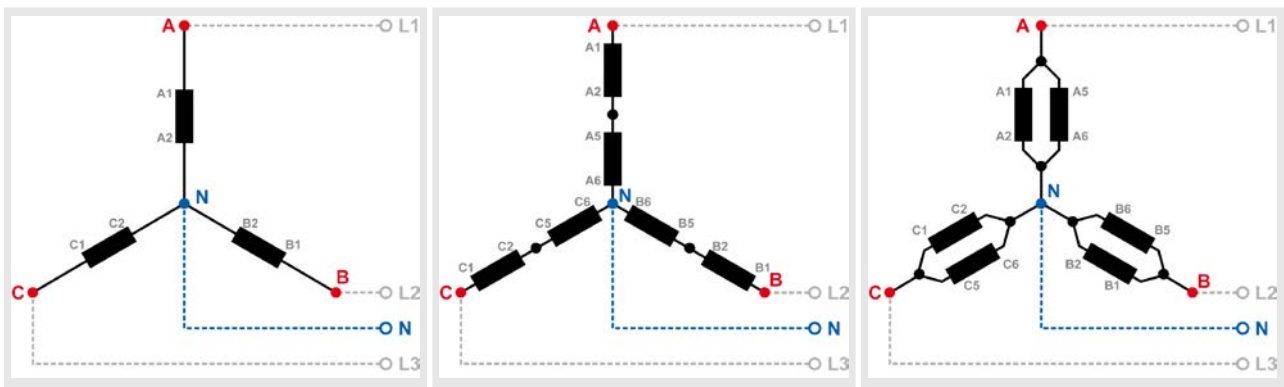

Table 8: Generator windings - 3Ph 4W

Measuring inputs

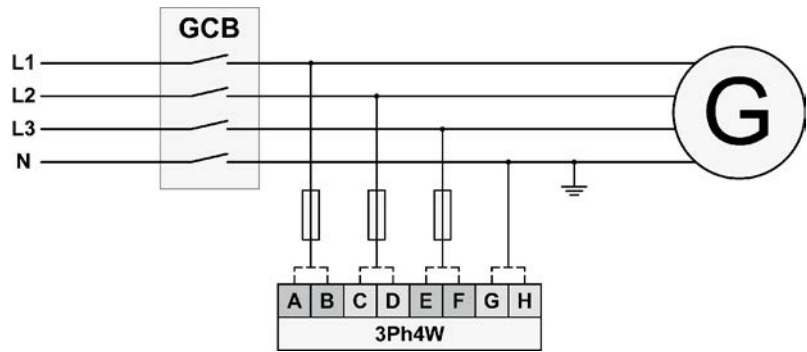

Fig. 25: Measuring inputs - 3Ph 4W

Terminal assignment

3Ph 4W	Wiring terminals							
	Rated voltage (range)	120 V (50 to 130 V <sub>eff.</sub> )				480 V (131 to 480 V <sub>eff.</sub> )		
Measuring range (max.)	0 to 150 Vac				0 to 600 Vac			
Terminal	A	C	E	G	B	D	F	H
	29	31	33	35	30	32	34	36
Phase	L1	L2	L3	N	L1	L2	L3	N



For different voltage systems, different wiring terminals have to be used.

Incorrect measurements are possible, if both voltage systems use the same N terminal.

3.3.5.1.3 Parameter Setting '3Ph 3W' (3-phase, 3-wire)

Generator windings

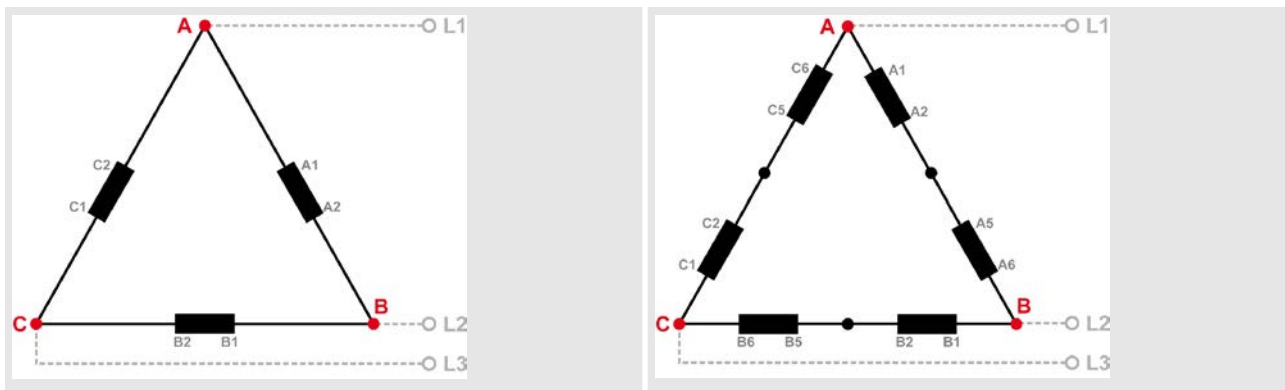

Table 9: Generator windings - 3Ph 3W

Measuring inputs

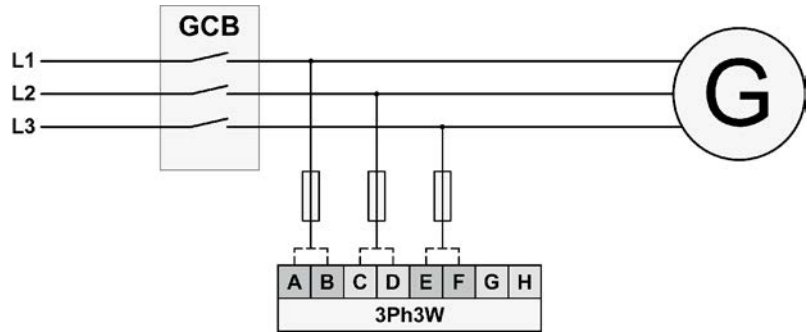

Fig. 26: Measuring inputs - 3Ph 3W

Terminal assignment

3Ph 3W	Wiring terminals							
	Rated voltage (range)	120 V (50 to 130 V <sub>eff.</sub> )				480 V (131 to 480 V <sub>eff.</sub> )		
Measuring range (max.)	0 to 150 Vac				0 to 600 Vac			
Terminal	A	C	E	G	B	D	F	H
	29	31	33	35	30	32	34	36
Phase	L1	L2	L3	—	L1	L2	L3	—



For different voltage systems, different wiring terminals have to be used.

3.3.5.1.4 Parameter Setting '1Ph 3W' (1-phase, 3-wire)

Generator windings

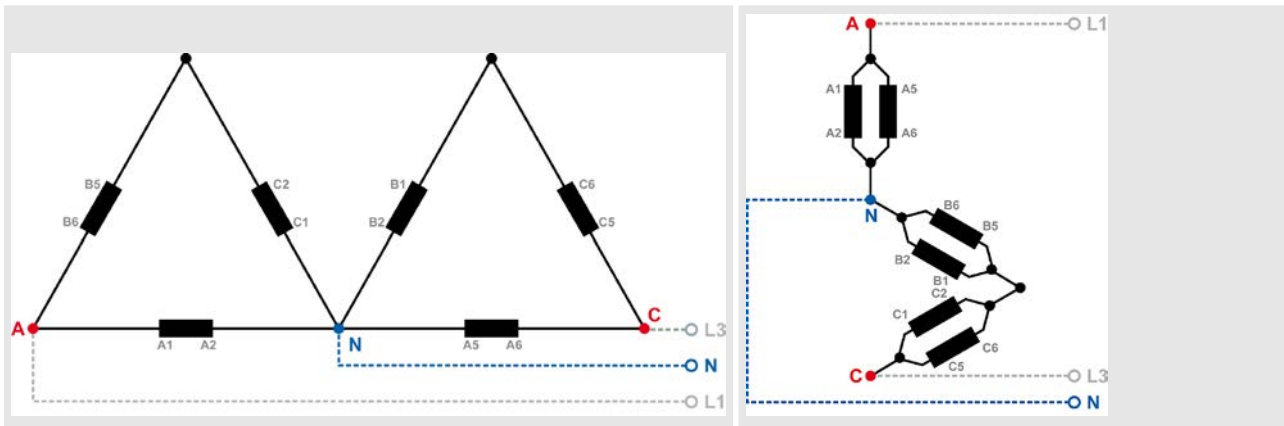

Table 10: Generator windings - 1Ph 3W

Measuring inputs

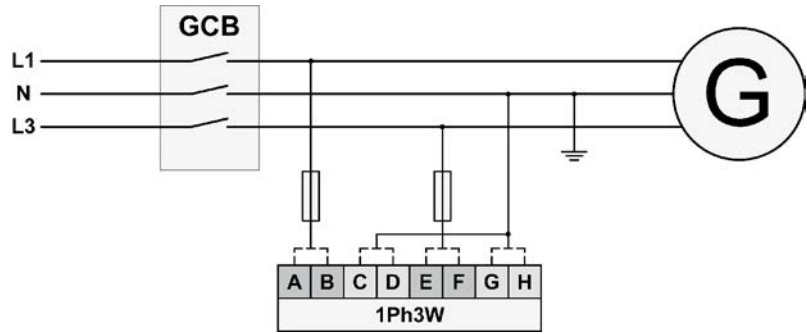

Fig. 27: Measuring inputs - 1Ph 3W

Terminal assignment

1Ph 3W	Wiring terminals							
Rated voltage (range)	120 V (50 to 130 V <sub>eff.</sub> )				480 V (131 to 480 V <sub>eff.</sub> )			
Measuring range (max.)	0 to 150 Vac				0 to 600 Vac			
Terminal	A	C	E	G	B	D	F	H
	29	31	33	35	30	32	34	36
Phase	L1	N	L3	N	L1	N	L3	N



For different voltage systems, different wiring terminals have to be used.

Incorrect measurements are possible, if both voltage systems use the same N terminal.

3.3.5.1.5 Parameter Setting '1Ph 2W' (1-phase, 2-wire)



The 1-phase, 2-wire measurement may be performed **phase-neutral** or **phase-phase**.

– Please note to configure and wire the easYgen consistently.

'1Ph 2W' Phase-Neutral Measuring

Generator windings

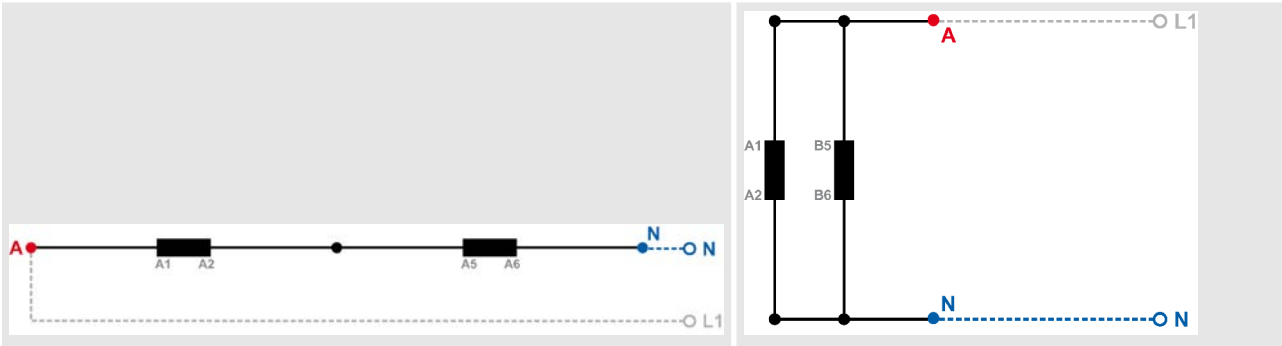

Table 11: Generator windings - 1Ph 2W (phase neutral)

Measuring inputs

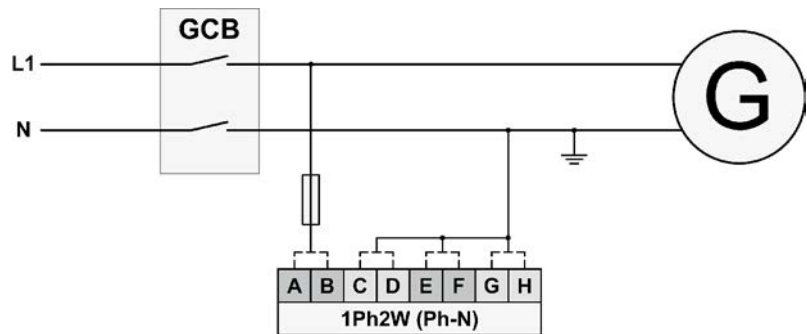

Fig. 28: Measuring inputs - 1Ph 2W (phase neutral)

Terminal assignment

1Ph 2W	Wiring terminals							
	Rated voltage (range)	120 V (50 to 130 V <sub>eff.</sub> )				480 V (131 to 480 V <sub>eff.</sub> )		
Measuring range (max.)	0 to 150 Vac				0 to 600 Vac			
Terminal	A	C	E	G	B	D	F	H
	29	31	33	35	30	32	34	36
Phase	L1	N	N	N	L1	N	N	N



For different voltage systems, different wiring terminals have to be used.

Incorrect measurements are possible if both voltage systems use the same N terminal.



Never configure the busbar measurement for phase-neutral, if the other systems like mains and generator are configured as 3ph 3W or 4ph 4W without being the neutral in the middle of the triangle.

The phase angle for synchronization would be incorrect.

'1Ph 2W' Phase-Phase Measuring

Generator windings

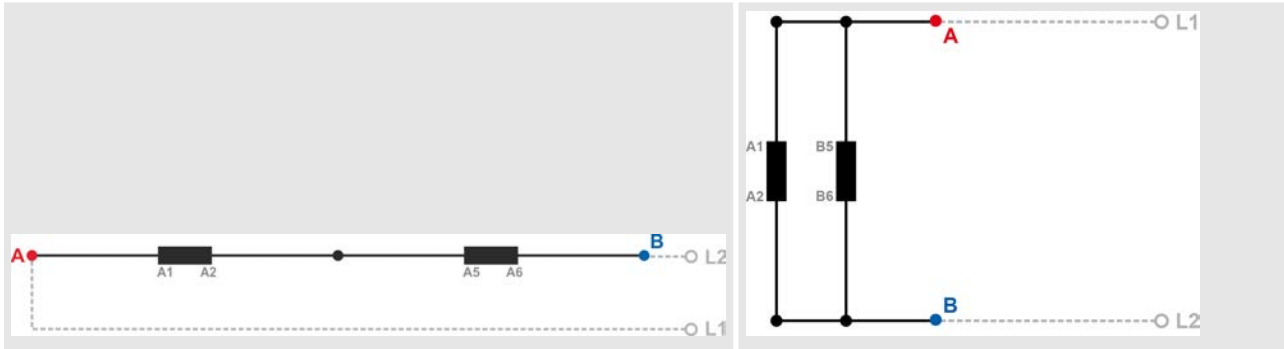

Table 12: Generator windings - 1Ph 2W (phase-phase)

Measuring inputs

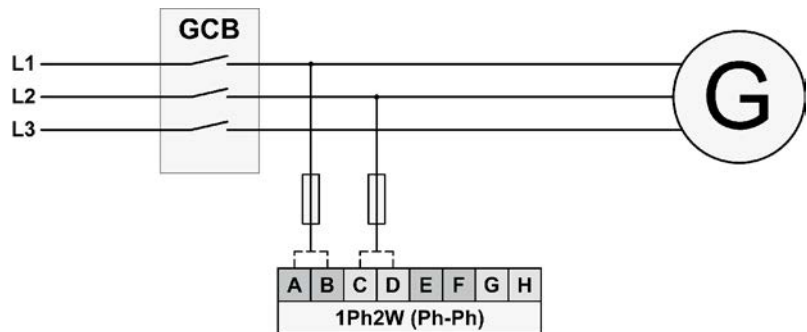

Fig. 29: Measuring inputs - 1Ph 2W (phase-phase)

Terminal assignment

1Ph 2W	Wiring terminals							
	Rated voltage (range)	120 V (50 to 130 V <sub>eff.</sub> )				480 V (131 to 480 V <sub>eff.</sub> )		
Measuring range (max.)	0 to 150 Vac				0 to 600 Vac			
Terminal	A	C	E	G	B	D	F	H
	29	31	33	35	30	32	34	36
Phase	L1	L2	—	—	L1	L2	—	—



For different voltage systems, different wiring terminals have to be used.

3.3.5.2 Mains Voltage

General notes



If parameter 1803 ↻ p. 101 ("Mains PT secondary rated volt.") is configured with a value between 50 and 130 V, the 120 V input terminals must be used for proper measurement.

If parameter 1803 ↻ p. 101 ("Mains PT secondary rated volt.") is configured with a value between 131 and 480 V, the 480 V input terminals must be used for proper measurement.



If the easYgen is intended to be operated in parallel with the mains, the mains voltage measuring inputs must be connected.

If an external mains decoupling is performed, jumpers between busbar and mains voltage measuring inputs may be installed.

Schematic and terminals

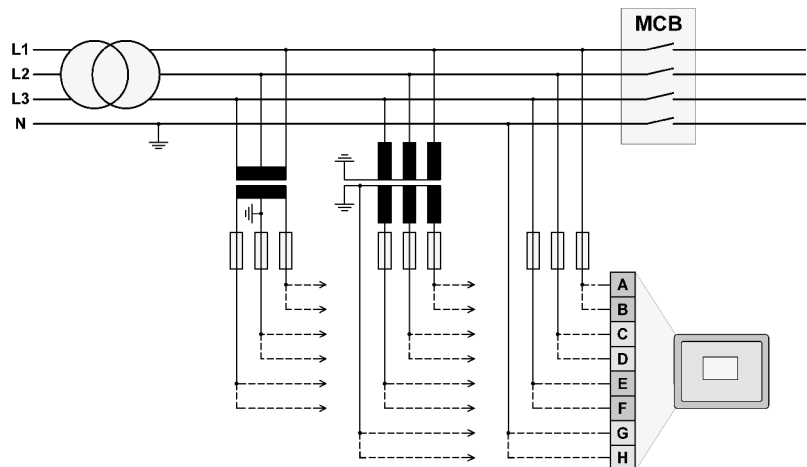

Fig. 30: Voltage measuring - mains - wiring

Terminal	Description	$A_{max}$
A	Mains voltage - L1	120 Vac
B		480 Vac
C	Mains voltage - L2	120 Vac
D		480 Vac
E	Mains voltage - L3	120 Vac
F		480 Vac
G	Mains voltage - N	120 Vac
H		480 Vac

Table 13: Voltage measuring - mains - terminal assignment

3.3.5.2.1 Parameter Setting '3Ph 4W' (3-phase, 4-wire)

Mains windings

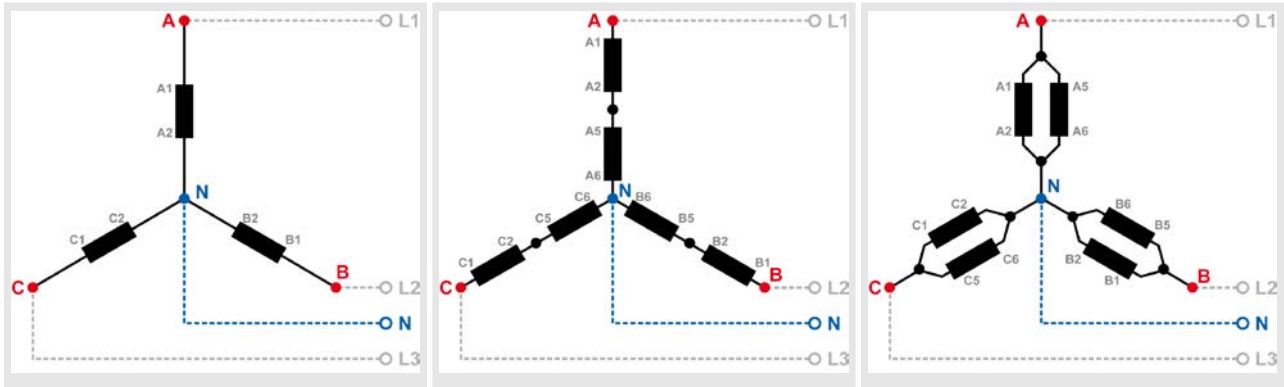

Table 14: Mains windings - 3Ph 4W

Measuring inputs

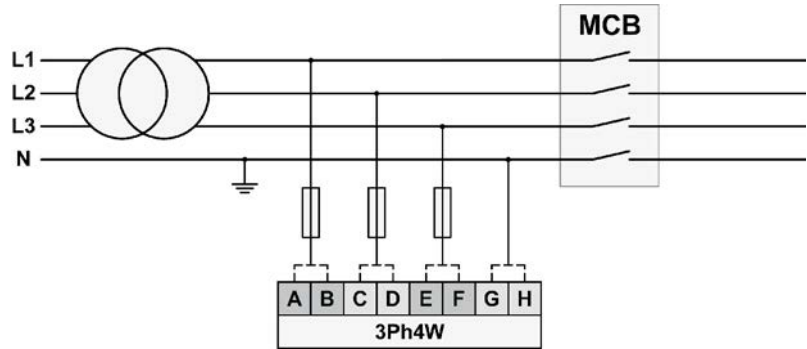

Fig. 31: Measuring inputs - 3Ph 4W

Terminal assignment

3Ph 4W	Wiring terminals							
	Rated voltage (range)	120 V (50 to 130 V <sub>eff.</sub> )				480 V (131 to 480 V <sub>eff.</sub> )		
Measuring range (max.)	0 to 150 Vac				0 to 600 Vac			
Terminal	A	C	E	G	B	D	F	H
	21	23	25	27	22	24	26	28
Phase	L1	L2	L3	N	L1	L2	L3	N



For different voltage systems, different wiring terminals have to be used.

Incorrect measurements are possible if both voltage systems use the same N terminal.



3.3.5.2.2 Parameter Setting '3Ph 3W' (3-phase, 3-wire)

Mains windings

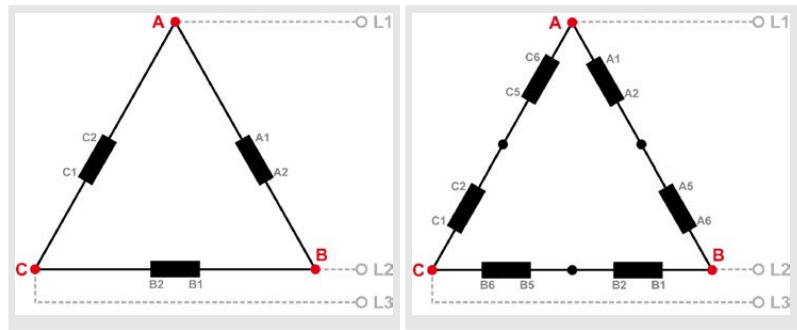

Table 15: Mains windings - 3Ph 3W

Measuring inputs

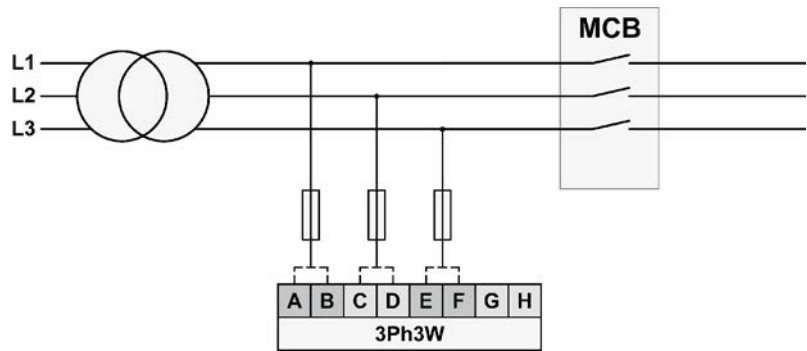

Fig. 32: Measuring inputs - 3Ph 3W

Terminal assignment

3Ph 3W	Wiring terminals							
	Rated voltage (range)	120 V (50 to 130 V <sub>eff.</sub> )				480 V (131 to 480 V <sub>eff.</sub> )		
Measuring range (max.)	0 to 150 Vac				0 to 600 Vac			
Terminal	A	C	E	G	B	D	F	H
	21	23	25	27	22	24	26	28
Phase	L1	L2	L3	---	L1	L2	L3	---



For different voltage systems, different wiring terminals have to be used.

3.3.5.2.3 Parameter Setting '1Ph 3W' (1-phase, 3-wire)

Mains windings

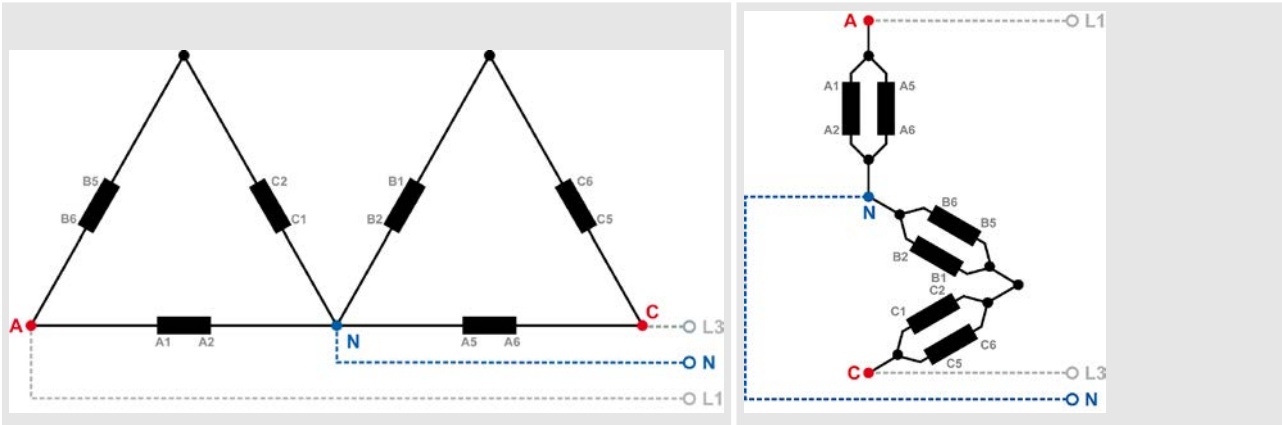

Table 16: Mains windings - 1Ph 3W

Measuring inputs

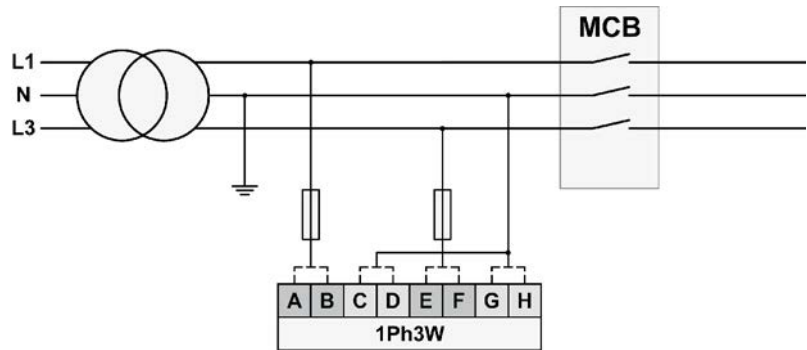

Fig. 33: Measuring inputs - 1Ph 3W

Terminal assignment

1Ph 3W	Wiring terminals							
	Rated voltage (range)	120 V (50 to 130 V <sub>eff.</sub> )				480 V (131 to 480 V <sub>eff.</sub> )		
Measuring range (max.)	0 to 150 Vac				0 to 600 Vac			
Terminal	A	C	E	G	B	D	F	H
	21	23	25	27	22	24	26	28
Phase	L1	N	L3	N	L1	N	L3	N



For different voltage systems, different wiring terminals have to be used.

Incorrect measurements are possible, if both voltage systems use the same N terminal.

3.3.5.2.4 Parameter Setting '1Ph 2W' (1-phase, 2-wire)



The 1-phase, 2-wire measurement may be performed **phase-neutral** or **phase-phase**.

- Please note to configure and wire the easYgen consistently.

'1Ph 2W' Phase-Neutral Measuring

Mains windings

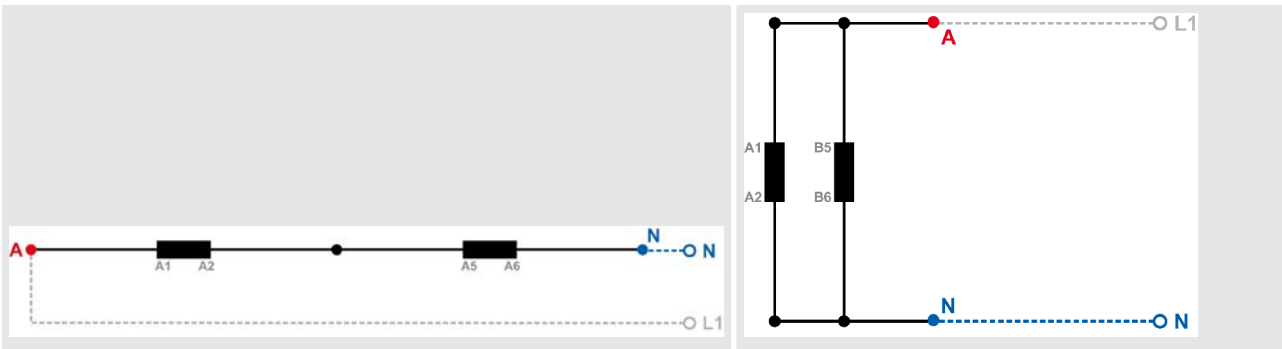

Table 17: Mains windings - 1Ph 2W (phase neutral)

Measuring inputs

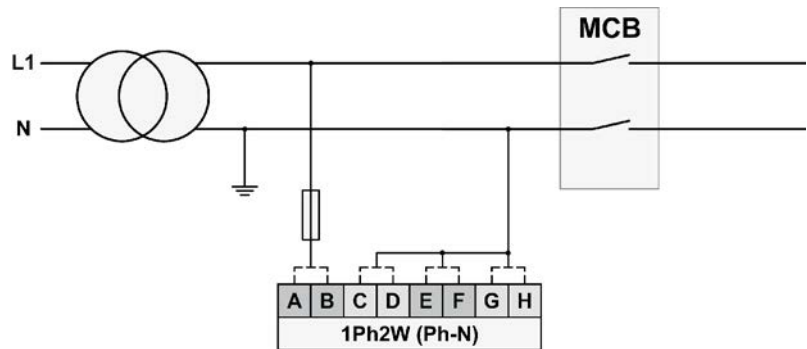

Fig. 34: Measuring inputs - 1Ph 2W (phase neutral)

Terminal assignment

1Ph 2W	Wiring terminals							
	Rated voltage (range)	120 V (50 to 130 V <sub>eff.</sub> )				480 V (131 to 480 V <sub>eff.</sub> )		
Measuring range (max.)	0 to 150 Vac				0 to 600 Vac			
Terminal	A	C	E	G	B	D	F	H
	21	23	25	27	22	24	26	28
Phase	L1	N	N	N	L1	N	N	N



For different voltage systems, different wiring terminals have to be used.

Incorrect measurements are possible, if both voltage systems use the same N terminal.

**'1Ph 2W' Phase-Phase Measuring  
Mains windings**

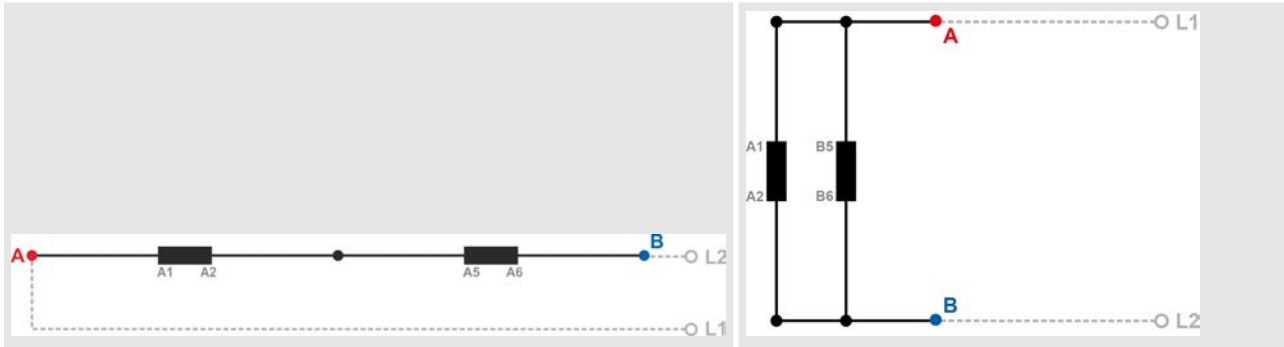

Table 18: Mains windings - 1Ph 2W (phase-phase)

**Measuring inputs**

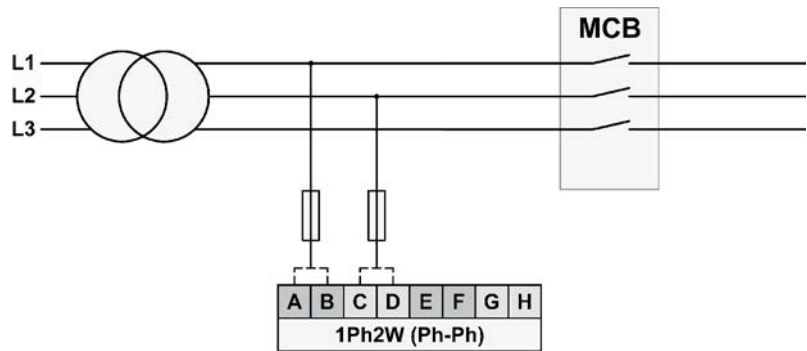

Fig. 35: Measuring inputs - 1Ph 2W (phase-phase)

**Terminal assignment**

1Ph 2W	Wiring terminals							
	Rated voltage (range)	120 V (50 to 130 V <sub>eff.</sub> )				480 V (131 to 480 V <sub>eff.</sub> )		
Measuring range (max.)	0 to 150 Vac				0 to 600 Vac			
Terminal	A	C	E	G	B	D	F	H
	21	23	25	27	22	24	26	28
Phase	L1	L2	---	---	L1	L2	---	---



For different voltage systems, different wiring terminals have to be used.

### 3.3.5.3 Busbar Voltage

#### General notes



If parameter 1812 ↪ p. 100 ("Bus1 PT secondary rated volt.") is configured with a value between 50 and 130 V, the 120 V input terminals must be used for proper measurement.

If parameter 1812 ↪ p. 100 ("Bus1 PT secondary rated volt.") is configured with a value between 131 and 480 V, the 480 V input terminals must be used for proper measurement.

#### Schematic and terminals

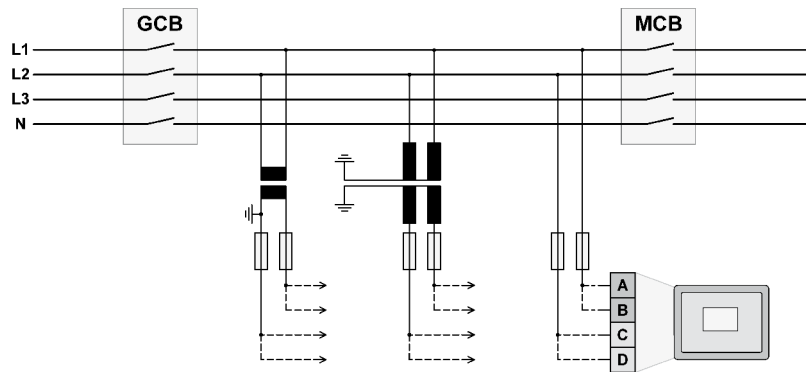

Fig. 36: Voltage measuring - busbar - wiring

Terminal	Description	$A_{max}$
A	37 Busbar voltage (system 1) - phase L1	120 Vac
B		480 Vac
C	39 Busbar voltage (system 1) - phase L2 / N	120 Vac
D		480 Vac

Table 19: Voltage measuring - busbar - terminal assignment

#### 3.3.5.3.1 Parameter Setting '1Ph 2W' (1-phase, 2-wire)



The 1-phase, 2-wire measurement may be performed **phase-neutral** or **phase-phase**.

– Please note to configure and wire the easYgen consistently.

**'1Ph 2W' Phase-Neutral Measuring**

**Busbar windings**

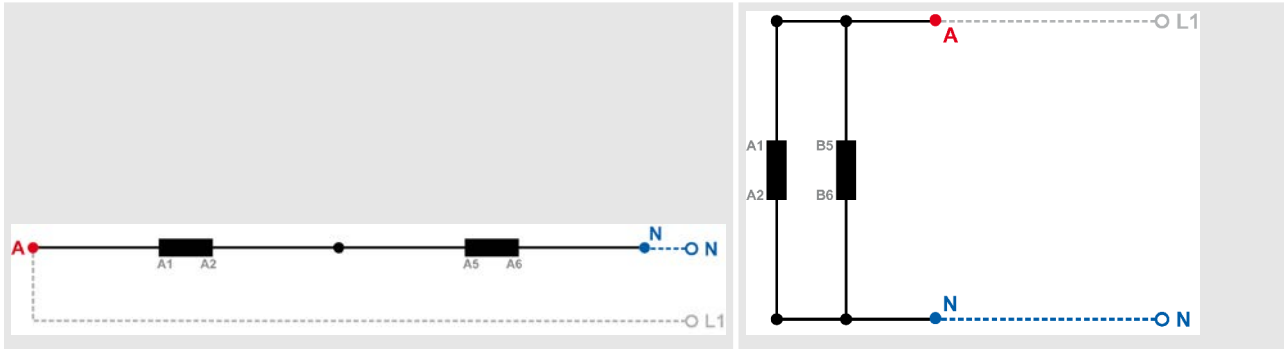

Table 20: Busbar windings - 1Ph 2W (phase neutral)

**Measuring inputs**

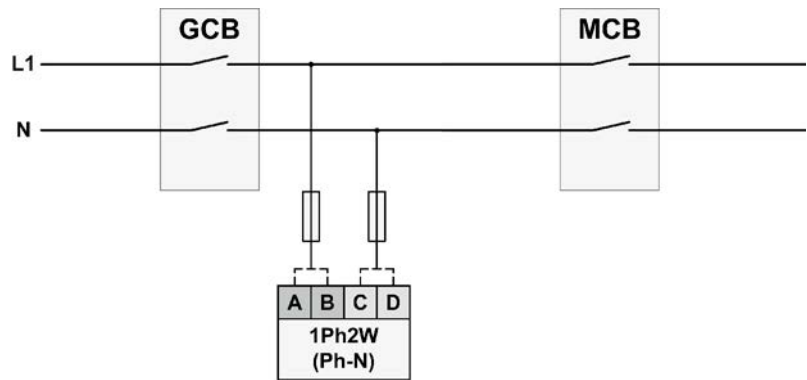

Fig. 37: Measuring inputs - 1Ph 2W (phase neutral)

**Terminal assignment**

1Ph 2W	Wiring terminals			
	Rated voltage (range)	120 V (50 to 130 V <sub>eff.</sub> )		480 V (131 to 480 V <sub>eff.</sub> )
Measuring range (max.)	0 to 150 Vac		0 to 600 Vac	
Terminal	A	C	B	D
	37	39	38	—
Phase	L1	N	L1	—



For different voltage systems, different wiring terminals have to be used.

Incorrect measurements are possible, if both voltage systems use the same N terminal.

**'1Ph 2W' Phase-Phase Measuring**

**Busbar windings**

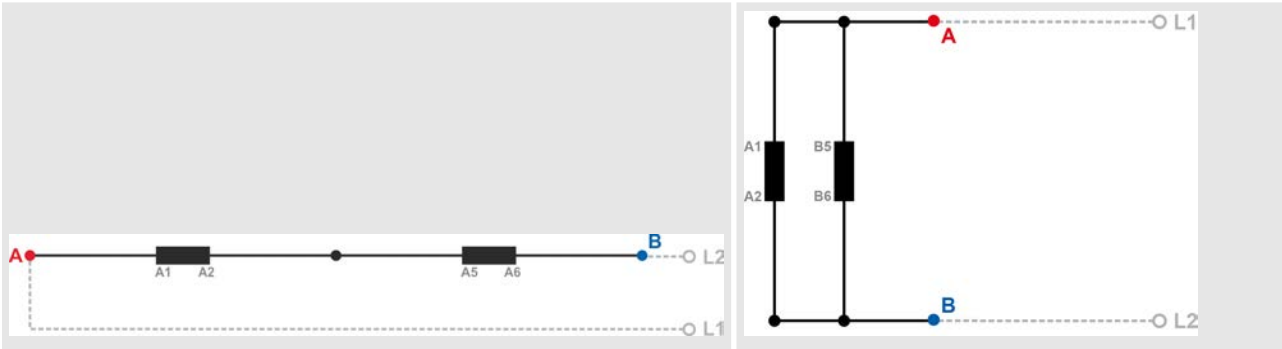

Table 21: Busbar windings - 1Ph 2W (phase-phase)

**Measuring inputs**

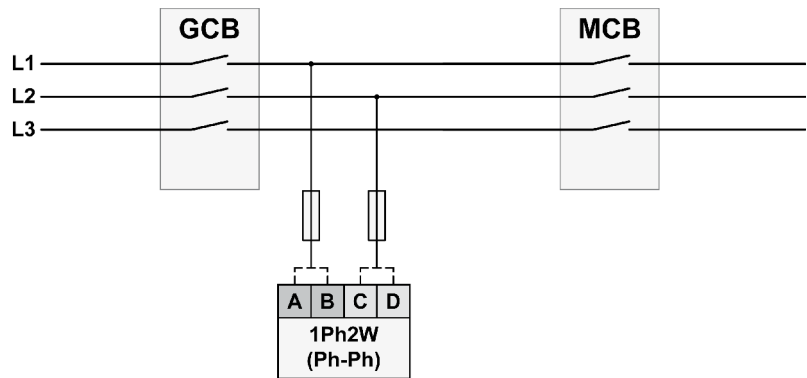

Fig. 38: Measuring inputs - 1Ph 2W (phase-phase)

**Terminal assignment**

1Ph 2W	Wiring terminals			
Rated voltage (range)	120 V (50 to 130 V <sub>eff.</sub> )		480 V (131 to 480 V <sub>eff.</sub> )	
Measuring range (max.)	0 to 150 Vac		0 to 600 Vac	
Terminal	A	C	B	D
	37	39	38	40
Phase	L1	L2	L1	L2



For different voltage systems, different wiring terminals have to be used.

### 3.3.6 Current Measuring

#### 3.3.6.1 Generator Current

##### General notes



**WARNING!**

**Dangerous voltages due to missing load**

- Before disconnecting the device, ensure that the current transformer (CT) is short-circuited.



Generally, one line of the current transformers secondary must be grounded close to the CT.

##### Schematic and terminals

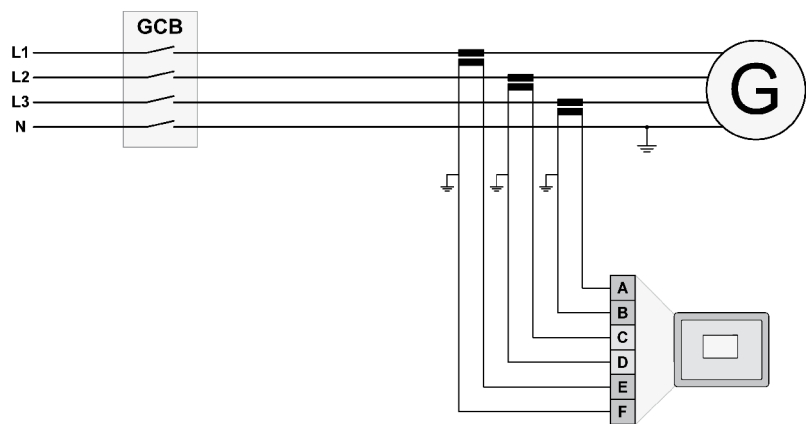

Fig. 39: Current measuring - generator - wiring

Terminal		Description	A <sub>max</sub>
A	8	Generator current - L3 - transformer terminal s1 (k)	2.5 mm <sup>2</sup>
B	7	Generator current - L3 - transformer terminal s2 (l)	2.5 mm <sup>2</sup>
C	6	Generator current - L2 - transformer terminal s1 (k)	2.5 mm <sup>2</sup>
D	5	Generator current - L2 - transformer terminal s2 (l)	2.5 mm <sup>2</sup>
E	4	Generator current - L1 - transformer terminal s1 (k)	2.5 mm <sup>2</sup>
F	3	Generator current - L1 - transformer terminal s2 (l)	2.5 mm <sup>2</sup>

Table 22: Current measuring - generator - terminal assignment



3.3.6.1.1 Parameter Setting 'L1 L2 L3'

Schematic and terminals

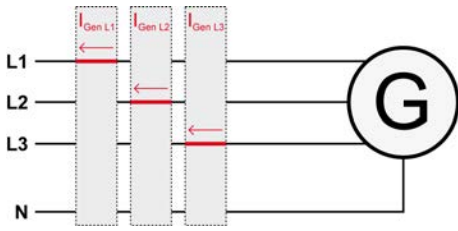

Fig. 40: Current measuring - generator, L1 L2 L3

		Wiring terminals					
		F	E	D	C	B	A
<b>L1 L2 L3</b>							
Terminal		3	4	5	6	7	8
Phase		s2 (l) L1	s1 (k) L1	s2 (l) L2	s1 (k) L2	s2 (l) L3	s1 (k) L3
<b>Phase L1 and L3</b>							
Terminal		3	4	5	6	7	8
Phase		s2 (l) L1	s1 (k) L1	—	—	s2 (l) L3	s1 (k) L3



"Phase L1 and L3" applies if the generator voltage measurement is configured to 1Ph 3W (Chapter 3.3.5.1.4 "Parameter Setting '1Ph 3W' (1-phase, 3-wire)" on page 51).

3.3.6.1.2 Parameter Setting 'Phase L1' 'Phase L2' 'Phase L3'

Schematic and terminals

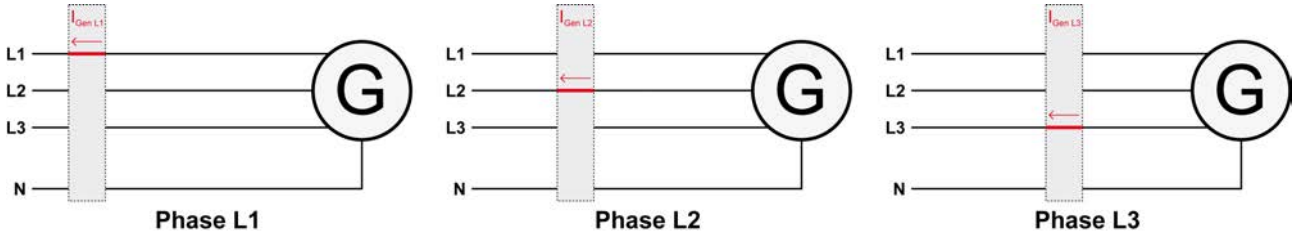

Fig. 41: Current measuring - generator, 'Phase L1' 'Phase L2' 'Phase L3'

		Wiring terminals					
		F	E	D	C	B	A
<b>Phase L1</b>							
Terminal		3	4	5	6	7	8
Phase		s2 (l) L1	s1 (k) L1	—	—	—	—
<b>Phase L2</b>							
Terminal		3	4	5	6	7	8
Phase		—	—	s2 (l) L2	s1 (k) L2	—	—
<b>Phase L3</b>							

	Wiring terminals					
Terminal	3	4	5	6	7	8
Phase	—	—	—	—	s2 (l) L3	s1 (k) L3

### 3.3.6.2 Mains Current

#### General notes



**WARNING!**

**Dangerous voltages due to missing load**

- Before disconnecting the device, ensure that the current transformer (CT) is short-circuited.



Generally, one line of the current transformers secondary must be grounded close to the CT.

#### Schematic and terminals

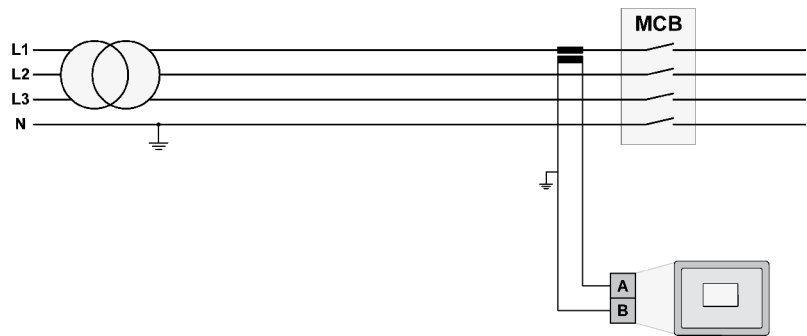

Fig. 42: Current measuring - mains - wiring

Terminal		Description	A <sub>max</sub>
A	2	Mains current - transformer terminal s1 (k)	2.5 mm <sup>2</sup>
B	1	Mains current - transformer terminal s2 (l)	2.5 mm <sup>2</sup>

Table 23: Current measuring - mains - terminal assignment

3.3.6.2.1 Parameter Setting 'Phase L1' 'Phase L2' 'Phase L3'

Schematic and terminals

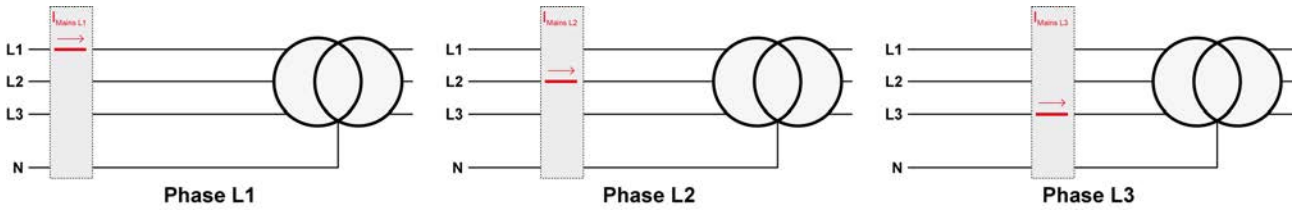

Fig. 43: Current measuring - mains, 'Phase L1' 'Phase L2' 'Phase L3'

	Wiring terminals	
	B	A
<b>Phase L1</b>		
Terminal	1	2
Phase	s2 (l) - L1	s1 (k) - L1
<b>Phase L2</b>		
Terminal	1	2
Phase	s2 (l) - L2	s1 (k) - L2
<b>Phase L3</b>		
Terminal	1	2
Phase	s2 (l) - L3	s1 (k) - L3

3.3.6.3 Ground Current

General notes



**WARNING!**

**Dangerous voltages due to missing load**

- Before disconnecting the device, ensure that the current transformer (CT) is short-circuited.



The mains current input can be configured to measure the mains current or ground current. The parameter 'Mains current input' determines, if this input will measure the mains current (default) or the ground current.



Generally, one line of the current transformers secondary must be grounded close to the CT.

Schematic and terminals

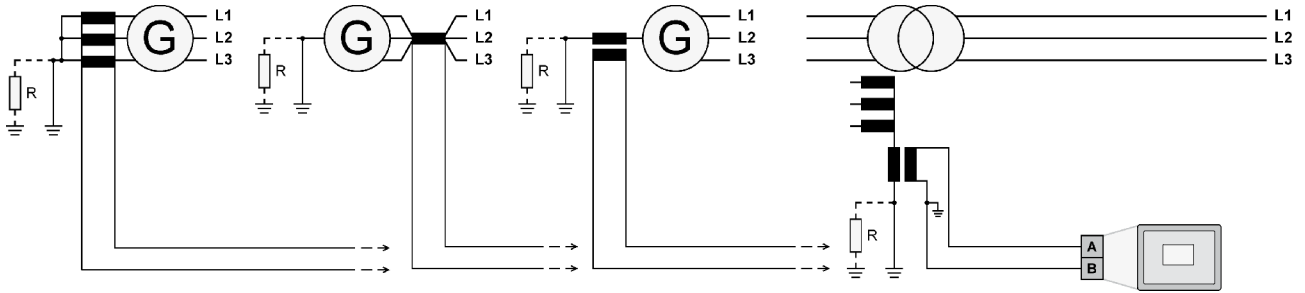

Fig. 44: Current measuring - ground current - wiring

Terminal	Description	A <sub>max</sub>
A 2	Ground current - transformer terminal s1 (k)	2.5 mm <sup>2</sup>
B 1	Ground current - transformer terminal s2 (l)	2.5 mm <sup>2</sup>

Table 24: Current measuring - ground current - terminal assignment

3.3.7 Power Measuring

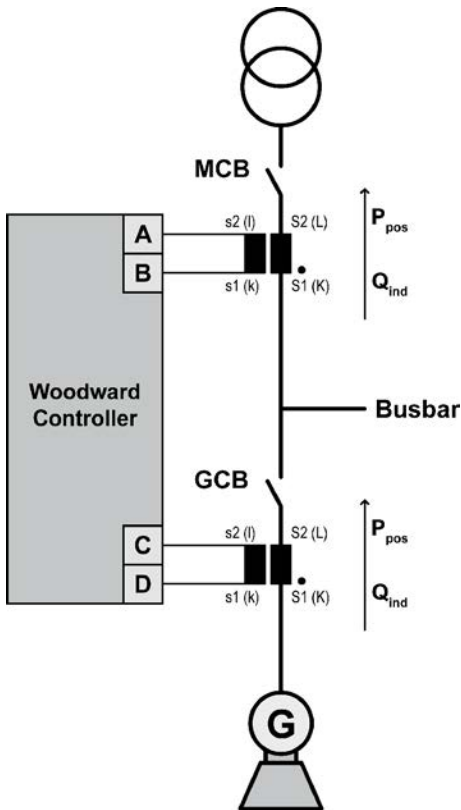

Fig. 45: Power measuring - wiring

If the unit's current transformers are wired according to the diagram ( Fig. 45), the following values are displayed.

Terminal	Description
A 1	Mains or ground current
B 2	
C 3 5 7	Generator current
D 4 6 8	

Parameter	Description	Sign displayed
Generator real power	Genset generating kW	+ Positive
Generator real power	Genset in reverse power	- Negative
Generator power factor (cos φ)	Inductive / lagging	+ Positive
Generator power factor (cos φ)	Capacitive / leading	- Negative
Mains real power	Plant exporting kW +	+ Positive
Mains real power	Plant importing kW -	- Negative
Mains power factor (cos φ)	Inductive / lagging	+ Positive
Mains power factor (cos φ)	Capacitive / leading	- Negative

### 3.3.8 Power Factor Definition

#### Definition

Power Factor is defined as a ratio of the real power to apparent power. In a purely resistive circuit, the voltage and current waveforms are instep resulting in a ratio or power factor of 1.00 (often referred to as unity).

In an inductive circuit the current lags behind the voltage waveform resulting in usable power (real power) and unusable power (reactive power). This results in a positive ratio or lagging power factor (i.e. 0.85lagging).

In a capacitive circuit the current waveform leads the voltage waveform resulting in usable power (real power) and unusable power (reactive power). This results in a negative ratio or a leading power factor (i.e. 0.85leading).

#### Properties

	Inductive	Capacitive
Load type	Electrical load whose current waveform lags the voltage waveform thus having a lagging power factor. Some inductive loads such as electric motors have a large startup current requirement resulting in lagging power factors.	Electrical load whose current waveform leads the voltage waveform thus having a leading power factor. Some capacitive loads such as capacitor banks or buried cable result in leading power factors.
Different power factor display on the unit	i0.91 (inductive) lg.91 (lagging)	c0.93 (capacitive) ld.93 (leading)
Reactive power display on the unit	70 kvar (positive)	-60 kvar (negative)
Output of the interface	+ (positive)	- (negative)
Current relation to voltage	Lagging	Leading
Generator state	Overexcited	Underexcited
Control signal	If the control unit is equipped with a power factor controller while in parallel with the utility:	
	A voltage lower "-" signal is output as long as the measured value is "more inductive" than the reference setpoint  Example: measured = i0.91; setpoint = i0.95	A voltage raise "+" signal is output as long as the measured value is "more capacitive" than the reference setpoint  Example: measured = c0.91; setpoint = c0.95

Phasor diagram



The phasor diagram is used from the generator's view.

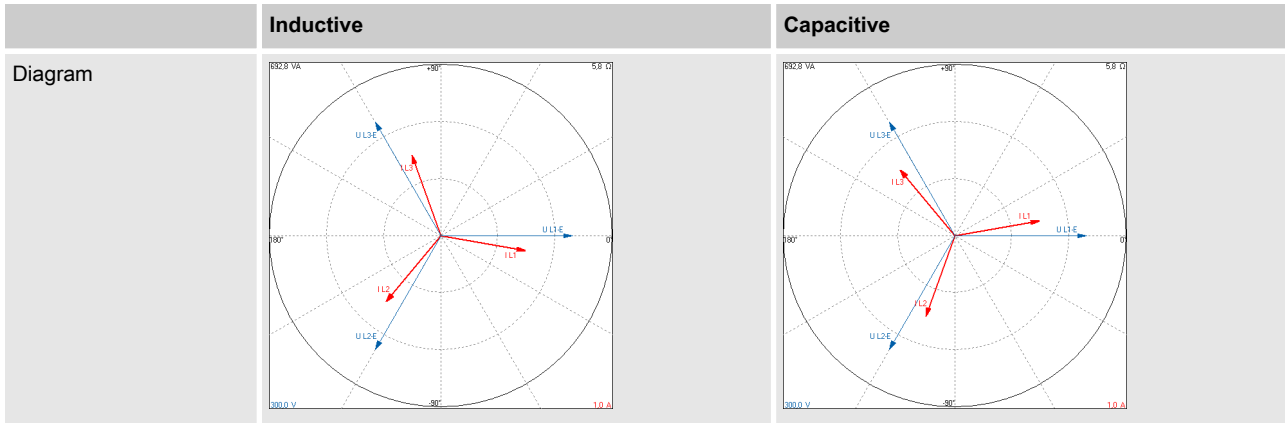

3.3.9 Magnetic Pickup Unit (MPU)

General notes



The shield of the MPU (Magnetic Pickup Unit) connection cable must be connected to a single point ground terminal near the easYgen.

The shield must not be connected at the MPU side of the cable.



The number of teeth on the flywheel reference gear and the flywheel speed must be configured so that the magnetic pickup input frequency does not exceed 14 kHz.

Overview

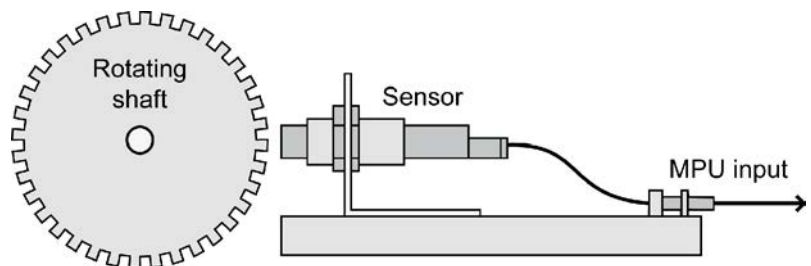

Fig. 46: MPU - overview

Schematic and terminals

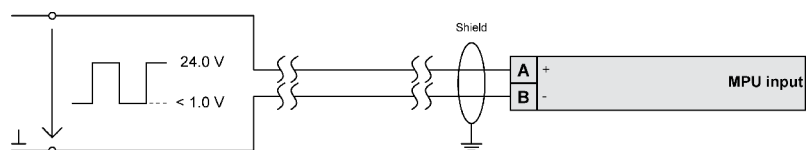

Fig. 47: MPU - input

Terminal		Description	A max.
A	79	MPU input - inductive/switching	2.5 mm <sup>2</sup>
B	80	MPU input - GND	2.5 mm <sup>2</sup>

**Characteristic**

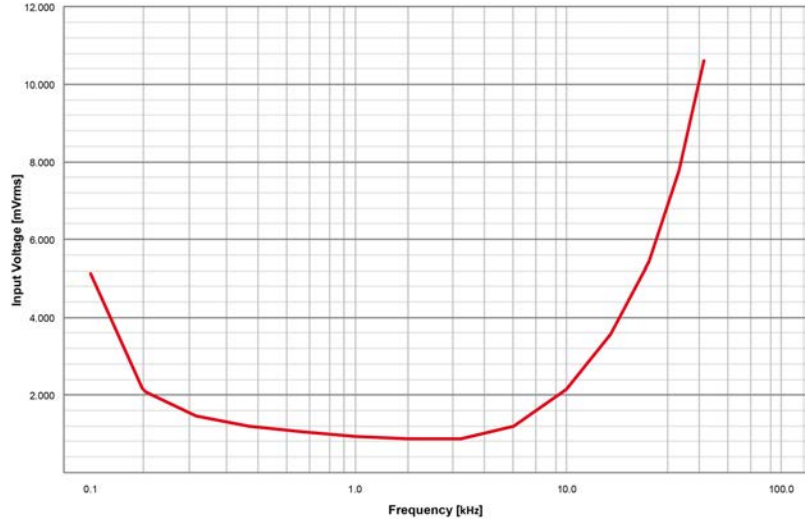

Fig. 48: MPU - characteristic



☞ "Overview" on page 70 shows the minimal necessary input voltage depending on frequency.

**3.3.10 Discrete Inputs**

**General notes**



**WARNING!**

**Hazards due to improper implementation of emergency stop**

Discrete input [DI 01] "Emergency Stop" is only a signaling input. This input may only be used to signal that an external emergency stop button has been actuated.

According to EN 60204, this input is not approved to be used as the emergency stop function.

- The emergency stop function must be implemented external to the control and cannot rely on the control to function properly.



The discrete inputs are electrically isolated which permits the polarity of the connections to be either positive or negative.

- All discrete inputs must use the same polarity, either positive or negative signals, due to the common ground.

**Schematic and terminal assignment**



Fig. 49: Discrete input - positive polarity signal



Fig. 50: Discrete input - negative polarity signal

Terminal		Description		A <sub>max</sub>
A	B			
66	67	Discrete Input [DI 01]	Preconfigured to "Emergency stop" <sup>1</sup>	2.5 mm <sup>2</sup>
GND	68	Discrete Input [DI 02]	Preconfigured to "Start in AUTO" <sup>1</sup>	2.5 mm <sup>2</sup>
Common ground	69	Discrete Input [DI 03]	Preconfigured to "Low oil pressure" <sup>1</sup>	2.5 mm <sup>2</sup>
	70	Discrete Input [DI 04]	Preconfigured to "Coolant temperature" <sup>1</sup>	2.5 mm <sup>2</sup>
	71	Discrete Input [DI 05]	Preconfigured to "Alarm acknowledge" <sup>1</sup>	2.5 mm <sup>2</sup>
	72	Discrete Input [DI 06]	Preconfigured to "Enable MCB" <sup>1</sup>	2.5 mm <sup>2</sup>
	73	Discrete Input [DI 07]	Fixed to "Reply: MCB open"	2.5 mm <sup>2</sup>
	74	Discrete Input [DI 08]	Fixed to "Reply: GCB open"	2.5 mm <sup>2</sup>
	75	Discrete Input [DI 09]	LogicsManager <sup>1</sup>	2.5 mm <sup>2</sup>
	76	Discrete Input [DI 10]	LogicsManager <sup>1</sup>	2.5 mm <sup>2</sup>
	77	Discrete Input [DI 11]	LogicsManager <sup>1</sup>	2.5 mm <sup>2</sup>
	78	Discrete Input [DI 12]	LogicsManager <sup>1</sup>	2.5 mm <sup>2</sup>

Table 25: DI 01-12



<sup>1</sup> configurable via LogicsManager

**Operation logic**

Discrete inputs may be configured to normally open (N.O.) or normally closed (N.C.) states.

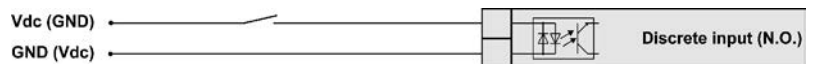

Fig. 51: Discrete inputs - state N.O.

In the state N.O., no potential is present during normal operation; if an alarm is issued or control operation is performed, the input is energized.

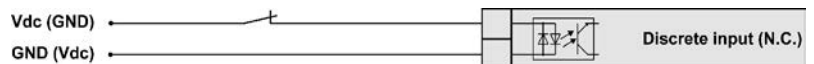

Fig. 52: Discrete inputs - state N.C.



In the state N.C., a potential is continuously present during normal operation; if an alarm is issued or control operation is performed, the input is de-energized.

The N.O. or N.C. contacts may be connected to the signal terminal as well as to the ground terminal of the discrete input ( ↪ *“Schematic and terminal assignment” on page 72* ).#

### 3.3.11 Relay Outputs (LogicsManager)

#### General notes



**CAUTION!**

The relay output "Ready for operation" must be wired in series with an emergency stop function. This means that it must be ensured that the generator circuit breaker is opened and the engine is stopped if this relay output is de-energize.

- We recommend to signal this fault independently from the unit if the availability of the plant is important.



For information on interference suppressing circuits when connecting 24 V relays, please refer to ↪ Chapter 3.5 "Connecting 24 V Relays" on page 82.

#### Schematic and terminals



Fig. 53: Relay outputs - schematic

Terminal		Description			A <sub>max</sub>
N.O.	Common				
A	B	Form A			
42	41	Relay output [R 01]	All	Fixed to "Ready for operation" <sup>1</sup>	2.5 mm <sup>2</sup>
43	46	Relay output [R 02]	All	Preconfigured to "Centralized alarm" <sup>1</sup>	2.5 mm <sup>2</sup>
44		Relay output [R 03]	All	Preconfigured to "Starter" <sup>1</sup>	2.5 mm <sup>2</sup>
45		Relay output [R 04]	All	Preconfigured to "Fuel solenoid / gas valve" <sup>1</sup>	2.5 mm <sup>2</sup>
48	47	Relay output [R 05]	All	Preconfigured to "Preglow" <sup>1</sup>	2.5 mm <sup>2</sup>
50	49	Relay output [R 06]	A01	LogicsManager <sup>1</sup>	2.5 mm <sup>2</sup>
			A02		
			A03	Preconfigured to "Command: close GCB" <sup>1</sup>	
			A04		
52	51	Relay output [R 07]	A01	Preconfigured to "Mains decoupling" <sup>1</sup>	2.5 mm <sup>2</sup>
			A02	Preconfigured to "Command: open GCB" <sup>1</sup>	

Terminal		Description			A <sub>max</sub>
N.O.	Common				
A	B	Form A			
			<b>A03</b>		
			<b>A04</b>		
54	53	Relay output [R 08]	<b>A01</b>	LogicsManager <sup>1</sup>	2.5 mm <sup>2</sup>
			<b>A02</b>		
			<b>A03</b>		
			<b>A04</b>	Preconfigured to "Command: close MCB" <sup>1</sup>	
56	55	Relay output [R 09]	<b>A01</b>	Preconfigured to "Mains decoupling" <sup>1</sup>	2.5 mm <sup>2</sup>
			<b>A02</b>		
			<b>A03</b>		
			<b>A04</b>	Preconfigured to "Command: open MCB" <sup>1</sup>	
57	60	Relay output [R 10]	All	Preconfigured to "Auxiliary services" <sup>1</sup>	2.5 mm <sup>2</sup>
58		Relay output [R 11]	All	Preconfigured to "Alarm class A and B" <sup>1</sup>	2.5 mm <sup>2</sup>
59		Relay output [R 12]	All	Preconfigured to "Alarm class C, D, E or F" <sup>1</sup>	2.5 mm <sup>2</sup>



<sup>1</sup> configurable via LogicsManager



**Notes**

- **LogicsManager:** Using the function Logics-Manager it is possible to freely program the relays for all application modes.
- **A01:** no breaker mode;
- **A02:** GCBopen
- **A03:** GCB
- **A04:** GCB/MCB
- **N.O.:** normally open (make) contact

**3.3.12 Analog Inputs (0 to 500 Ohm | 0/4 to 20 mA)**

It is recommended to use two-pole analog senders for best possible accuracy of the 20 mA inputs.



Connect the resistive analog input's return wires (GND) to PE (terminal 61; for two-pole senders) or engine ground (terminal 62; for single-pole senders) as close to the easYgen terminals as possible.

The following curves may be used for the analog inputs:

- Table A
- Table B

- Linear
- Pt100
- VDO 120° C
- VDO 150° C
- VDO 10 bar
- VDO 5 bar

The 9 setpoints of the free configurable Tables A and B can be selected for Type definition (parameters 1000, 1050, and 1100).



*A catalog of all available VDO sensors is available for download at the VDO homepage (<http://www.vdo.com>)*

**Wiring two-pole senders**



**Plastic housing**

*To ensure accurate system measurements, all VDO sending units must utilize insulated wires that are connected to the easYgen analog input ground (terminals 9/11/13).*

*Terminals 9/11/13 must have jumper wires connected to the PE connection (terminal 61).*



**Sheet metal housing**

*To ensure accurate system measurements, all VDO sending units must utilize insulated wires that are connected to the easYgen analog input ground (terminals 9/11/13).*

*Terminals 9/11/13 must have jumper wires connected to the PE connection (located at the bottom center of the sheet metal housing).*

*The protective earth terminal 61 is not connected on the sheet metal housing.*

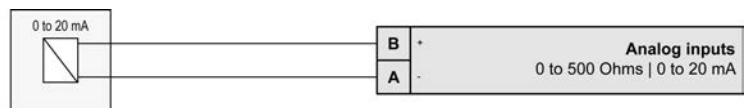

Fig. 54: Analog inputs - wiring two-pole senders (20 mA)

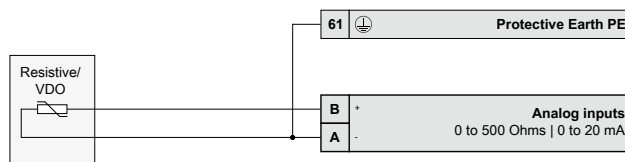

Fig. 55: Analog inputs - wiring two-pole senders (resistive)

Terminal	Description	A <sub>max</sub>
A 9	Analog input [AI 01] ground, connected with PE	2.5 mm <sup>2</sup>
B 10	Analog input [AI 01]	2.5 mm <sup>2</sup>
A 11	Analog input [AI 02] ground, connected with PE	2.5 mm <sup>2</sup>
B 12	Analog input [AI 02]	2.5 mm <sup>2</sup>
A 13	Analog input [AI 03] ground, connected with PE	2.5 mm <sup>2</sup>
B 14	Analog input [AI 03]	2.5 mm <sup>2</sup>

**Wiring single-pole senders**

The specified accuracy for single-pole sensors can only be achieved if the differential voltage between the genset chassis ground and PE does not exceed +/- 2.5 V.



**Sheet metal housing**

The protective earth terminal 61 is not connected on the sheet metal housing.

The PE connection (located at the bottom center of the sheet metal housing) must be used instead.

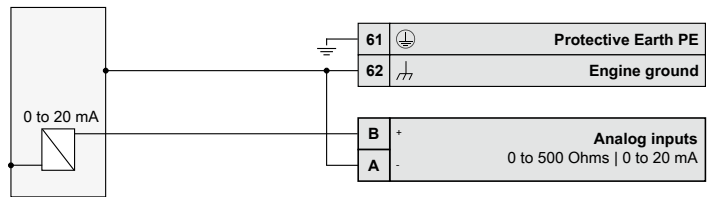

Fig. 56: Analog inputs - wiring single-pole senders (20 mA)

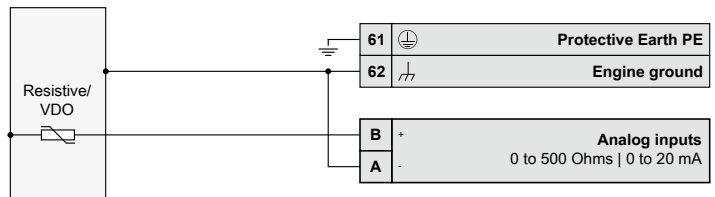

Fig. 57: Analog inputs - wiring single-pole senders (resistive)

Terminal	Description	A <sub>max</sub>
A 9	Analog input [AI 01] ground, connected with engine ground	2.5 mm <sup>2</sup>
B 10	Analog input [AI 01]	2.5 mm <sup>2</sup>
A 11	Analog input [AI 02] ground, connected with engine ground	2.5 mm <sup>2</sup>
B 12	Analog input [AI 02]	2.5 mm <sup>2</sup>

Terminal	Description	A <sub>max</sub>
A 13	Analog input [AI 03] ground, connected with engine ground	2.5 mm <sup>2</sup>
B 14	Analog input [AI 03]	2.5 mm <sup>2</sup>

**Wiring single and two-pole senders simultaneously**

It is possible to combine single- and two-pole senders but with the lower accuracy (all applications shown in the chapters “Wiring two-pole senders” on page 75 and “Wiring single-pole senders” on page 76 can be used in any possible combination). The specified accuracy for single-pole sensors can only be achieved if the differential voltage between the genset chassis ground and PE does not exceed +/- 2.5 V.

**3.3.13 Analog Outputs**

The easYgen offers current, voltage or PWM analog outputs for different applications. Most commonly they are used for speed and voltage biasing.

Controller configuration and an external jumper can change the multifunction controller bias output signals. The analog outputs are galvanically isolated.

**3.3.13.1 Analog Outputs ( $\pm 20$  mA,  $\pm 10$  V, PWM)**

**Controller wiring - three wires**



Fig. 58: Analog controller output - three wires

Type	Terminal	Description	A <sub>max</sub>
I Current	A 15	Analog output [AO 01]	2.5 mm <sup>2</sup>
	B 16		2.5 mm <sup>2</sup>
	C 17		2.5 mm <sup>2</sup>
V Voltage	A—B 15&16*	VA	2.5 mm <sup>2</sup>
	C 17	GND	2.5 mm <sup>2</sup>
PWM	A—B 15&16*	PWM	2.5 mm <sup>2</sup>
	C 17	GND	2.5 mm <sup>2</sup>
I Current	A 18	Analog output [AO 02]	2.5 mm <sup>2</sup>
	B 19		2.5 mm <sup>2</sup>
	C 20		2.5 mm <sup>2</sup>
V Voltage	A—B 18&19*	VA	2.5 mm <sup>2</sup>
	C 20	GND	2.5 mm <sup>2</sup>
PWM	A—B 18&19*	PWM	2.5 mm <sup>2</sup>
	C 20	GND	2.5 mm <sup>2</sup>
* external jumper			



*In case that higher permanent insulation voltages are required than described in the technical data, please install isolation equipment (isolation amplifier) for proper and safe operation.*



**CAUTION!**

Connecting external power sources to the analog outputs may damage the device.

**3.3.14 Serial Interfaces**

**3.3.14.1 RS-485 Interface**

**General notes**



*The easYgen must be configured for half- or full-duplex configuration.*



*Please note that connection always is:*  
**A ↔ A' and B ↔ B'.**

**Pin assignment**

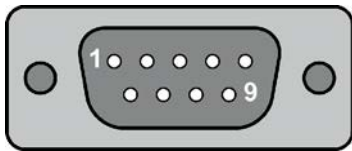

*Fig. 59: SUB-D connector - pins*

Terminal	Description	A <sub>max</sub>
1	Connected with connector housing and internally grounded via RC element	N/A
2	B (TxD+)	N/A
3	Not connected	N/A
4	B' (RxD+)	N/A
5	Not connected	N/A
6	Not connected	N/A
7	A (TxD-)	N/A
8	Not connected	N/A
9	A' (RxD-)	N/A

*Table 26: Pin assignment*

**RS-485 half-duplex**

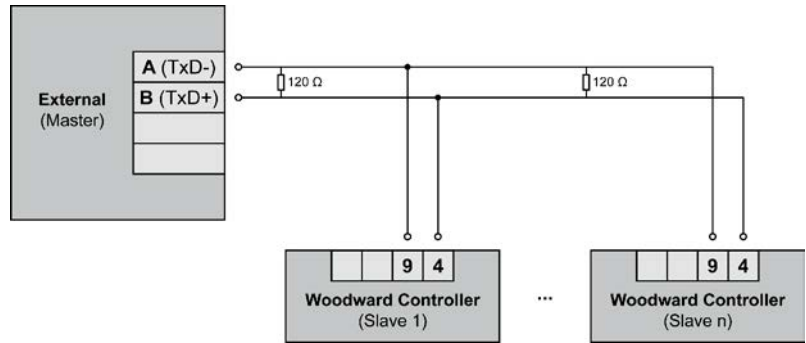

Fig. 60: RS-485 - connection for half-duplex operation

**RS-485 full-duplex**

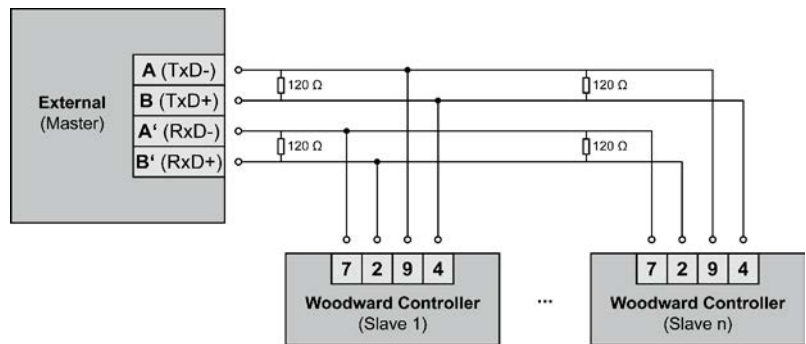

Fig. 61: RS-485 - connection for full-duplex operation

**Shielding**

easYgen is prepared for shielding: Terminal 1 and the connector housing are internally grounded via an RC element.

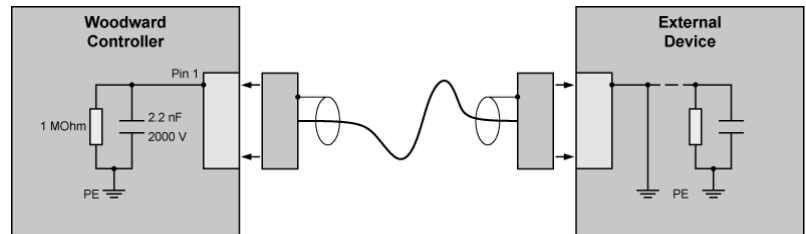

Fig. 62: Shielding preparation (internal RC element)

**3.3.14.2 RS-232 Interface**

**Pin assignment**

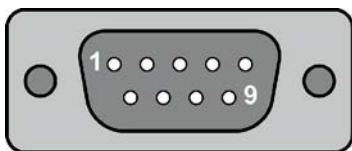

Fig. 63: SUB-D connector - pins

Terminal	Description	A <sub>max</sub>
1	Not connected	N/A
2	RxD (receive data)	N/A
3	TxD (transmit data)	N/A
4	Not connected	N/A
5	GND (system ground)	N/A
6	Not connected	N/A
7	RTS (request to send)	N/A

Terminal	Description	A <sub>max</sub>
8	CTS (clear to send)	N/A
9	Not connected	N/A

Table 27: Pin assignment

### 3.4 CAN Bus Interfaces

#### Pin assignment

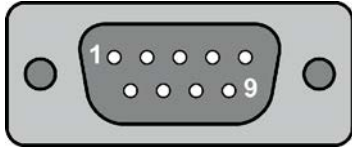

Fig. 64: SUB-D connector - pins

Terminal	Description	A <sub>max</sub>
1	Not connected	N/A
2	CAN-L	N/A
3	GND	N/A
4	Not connected	N/A
5	Connected with connector housing and internally grounded via RC element	N/A
6	Not connected	N/A
7	CAN-H	N/A
8	Not connected	N/A
9	Not connected	N/A

Table 28: Pin assignment

#### Topology



Please note that the CAN bus must be terminated with a resistor, which corresponds to the impedance of the cable (e.g. 120 Ohms, 1/4 W) at both ends.

The termination resistor is connected between CAN-H and CAN-L ( Fig. 65).

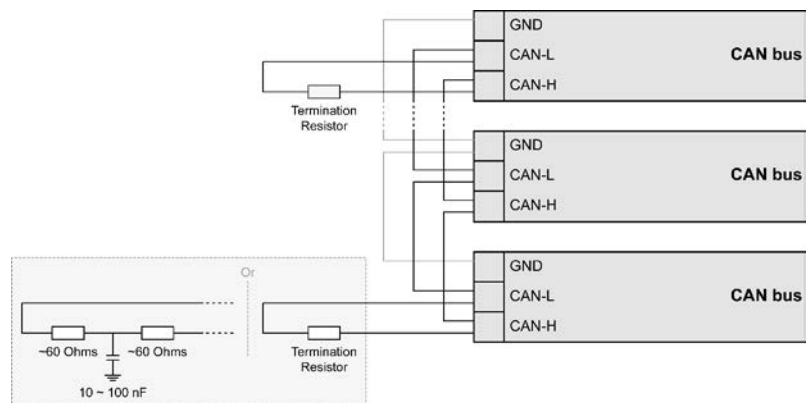

Fig. 65: CAN bus - termination



For very critical EMC conditions (many noise sources with high noise levels) and for high transmission rates we recommend to use the 'Split termination concept' as shown.

- Divide the termination resistance into 2x60 Ohms with a center tap connected to ground via a capacitor of 10 to 100 nF ( Fig. 65).

**Maximum CAN bus length**

The maximum length of the communication bus wiring is dependent on the configured baud rate. Observe the maximum bus length.

(Source: CANopen; Holger Zeltwanger (Hrsg.); 2001 VDE VERLAG GMBH, Berlin und Offenbach; ISBN 3-8007-2448-0).

Baud rate	Max. length
1000 kbit/s	25 m
800 kbit/s	50 m
500 kbit/s	100 m
250 kbit/s	250 m
125 kbit/s	500 m
50 kbit/s	1000 m
20 kbit/s	2500 m

**Bus shielding**

All bus connections of the easYgen are internally grounded via an RC element. Therefore, they may either be grounded directly (recommended) or also via an RC element on the opposite bus connection.

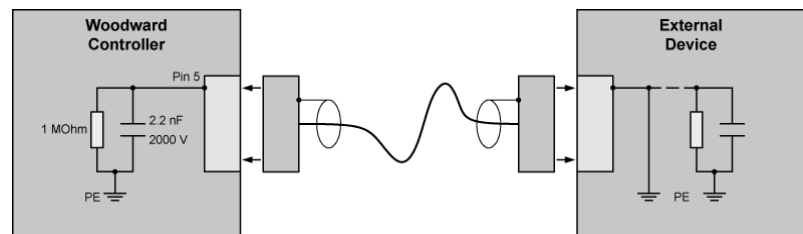

Fig. 66: Bus shielding (internal RC element)

**Troubleshooting**



*If there is no data transmission on the CAN bus, check the for the following common CAN bus communication problems:*

- A T-structure bus is utilized
- CAN-L and CAN-H are switched
- Not all devices on the bus are using identical baud rates
- Termination resistor(s) are missing
- The configured baud rate is too high for wiring length
- The CAN bus cable is routed in close proximity with power cables



Woodward recommends the use of shielded, twisted-pair cables for the CAN bus (see examples).

- Lappkabel Unitronic LIYCY (TP) 2x2x0.25
- UNITRONIC-Bus LD 2x2x0.22

### 3.5 Connecting 24 V Relays



**NOTICE!**

**Damage to adjacent electronic components due to induced voltages**

- Implement protection circuits as detailed below.

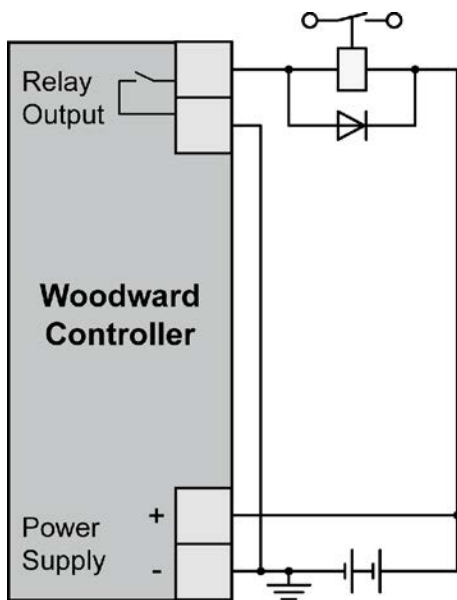

Fig. 67: Protection circuit (example)

Interferences in the interaction of all components may affect the function of electronic devices. One interference factor is disabling inductive loads, like coils of electromagnetic switching devices.

When disabling such a device, high switch-off induced voltages may occur, which might destroy adjacent electronic devices or result interference voltage pulses, which lead to functional faults, by capacitive coupling mechanisms.

Since an interference-free switch-off is not possible without additional equipment, the relay coil is connected with an interference suppressing circuit.

If 24 V (coupling) relays are used in an application, it is required to connect a protection circuit to avoid interferences.



Fig. 67 shows the exemplary connection of a diode as an interference suppressing circuit.

Advantages and disadvantages of different interference suppressing circuits are as follows:

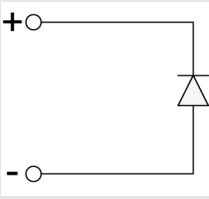
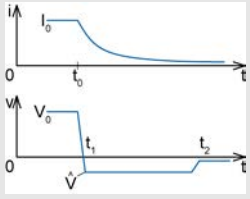
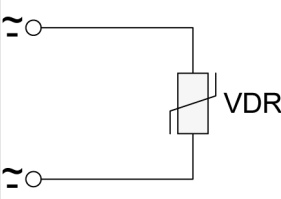
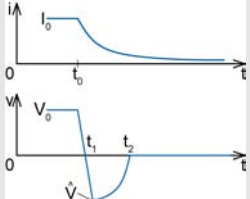
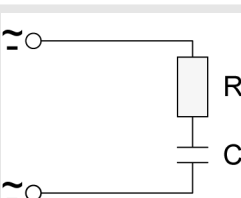
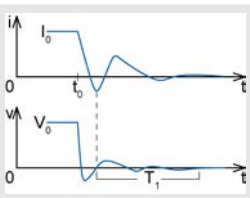
Connection diagram	Load current / voltage curve	Advantages	Disadvantages
		<ul style="list-style-type: none"> <li>Uncritical dimensioning</li> <li>Lowest possible induced voltage</li> <li>Very simple and reliable</li> </ul>	<ul style="list-style-type: none"> <li>High release delay</li> </ul>
		<ul style="list-style-type: none"> <li>Uncritical dimensioning</li> <li>High energy absorption</li> <li>Very simple setup</li> <li>Suitable for AC voltage</li> <li>Reverse polarity protected</li> </ul>	<ul style="list-style-type: none"> <li>No attenuation below VVDR</li> </ul>
		<ul style="list-style-type: none"> <li>HF attenuation by energy storage</li> <li>Immediate shut-off limiting</li> <li>Attenuation below limiting voltage</li> <li>Very suitable for AC voltage</li> <li>Reverse polarity protected</li> </ul>	<ul style="list-style-type: none"> <li>Exact dimensioning required</li> </ul>



## 4 Configuration

All parameters are assigned a unique parameter identification number.

The parameter identification number may be used to reference individual parameters listed in this manual.



*This parameter identification number is also displayed in the ToolKit configuration screens next to the respective parameter.*

### 4.1 Basic Setup

#### 4.1.1 Configure Language/Clock

##### General notes

The following parameters are used to set the unit language, the current date and time, and the daylight saving time feature.



*If an Asian language is configured, some parameter screens may be displayed with an empty space at the bottom of the parameter list, which may be interpreted as an end of the list, although more parameters exist and are displayed when scrolling down.*

ID	Parameter	CL	Setting range [Default]	Description
1700	<b>Language</b> (Set language)	0	selectable languages [English]	The desired language for the unit display text is configured here. Available languages are: English, German, Spanish, French, Italian, Portugese, Japanese, Chinese, Russian, Turkish, Polish, Slovenian, Finnish, Swedish.
1710	<b>Hour</b>	0	hour 0 to 23 h [real-time clock]	The hour of the clock time is set here.  <b>Example</b> <ul style="list-style-type: none"> <li>■ 0 = 0th hour of the day (midnight).</li> <li>■ 23 = 23rd hour of the day (11 pm).</li> </ul>
1709	<b>Minute</b>	0	0 to 59 min [real-time clock]	The minute of the clock time is set here.  <b>Example</b> <ul style="list-style-type: none"> <li>■ 0 = 0th minute of the hour</li> <li>■ 59 = 59th minute of the hour</li> </ul>
1708	<b>Second</b>	0	0 to 59 s [real-time clock]	The second of the clock time is set here.

## Configuration

Basic Setup > Configure Language/Clock

ID	Parameter	CL	Setting range [Default]	Description
				<b>Example</b> <ul style="list-style-type: none"> <li>■ 0 = 0th second of the minute</li> <li>■ 59 = 59th second of the minute</li> </ul>
1711	Day	0	day 1 to 31 [real-time clock]	The day of the date is set here.
				<b>Example</b> <ul style="list-style-type: none"> <li>■ 1 = 1st day of the month.</li> <li>■ 31 = 31st day of the month.</li> </ul>
1712	Month	0	month 1 to 12 [real-time clock]	The month of the date is set here.
				<b>Example</b> <ul style="list-style-type: none"> <li>■ 1 = 1st month of the year.</li> <li>■ 12 = 12th month of the year.</li> </ul>
1713	Year	0	year 0 to 99 [real-time clock]	The year of the date is set here.
				<b>Example</b> <ul style="list-style-type: none"> <li>■ 0 = Year 2000</li> <li>■ 99 = Year 2099</li> </ul>
4591	Daylight saving time	2		<p>The daylight saving time feature enables to automatically adjust the real-time clock to local daylight saving time (DST) provisions. If daylight saving time is enabled, the real-time clock will automatically be advanced by one hour when the configured DST begin date and time is reached and falls back again by one hour when the configured DST end date and time is reached.</p> <p>If the unit is used in the southern hemisphere, the DST function will be inverted automatically, if the DST begin month is later in the year than the DST end month.</p>
			On	Daylight saving time is enabled.
			[Off]	Daylight saving time is disabled.
				<b>Notes</b> <p>Do not change the time manually during the hour of the automatic time change if DST is enabled to avoid a wrong time setting.</p> <p>Events or alarms, which occur during this hour might have a wrong time stamp.</p>
4594	DST begin time	2	0 to 23 [0]	The real-time clock will be advanced by one hour when this time is reached on the DST begin date.
				<b>Example</b> <ul style="list-style-type: none"> <li>■ 0 = 0th hour of the day (midnight)</li> <li>■ 23 = 23rd hour of the day (11 pm)</li> </ul>

ID	Parameter	CL	Setting range [Default]	Description
				<p><b>Notes</b></p> <p>This parameter is only displayed, if Daylight saving time (parameter 4591 ↗ p. 86) is set to "On".</p>
4598	DST begin weekday	2	Sunday to Saturday [Sunday]	<p>The weekday for the DST begin date is configured here</p> <p><b>Notes</b></p> <p>This parameter is only displayed, if Daylight saving time (parameter 4591 ↗ p. 86) is set to "On".</p>
4592	DST begin nth. weekday	2		<p>The order number of the weekday for the DST begin date is configured here.</p>
			[1st]	DST starts on the 1st configured weekday of the DST begin month.
			2nd	DST starts on the 2nd configured weekday of the DST begin month.
			3rd	DST starts on the 3rd configured weekday of the DST begin month.
			4th	DST starts on the 4th configured weekday of the DST begin month.
			Last	DST starts on the last configured weekday of the DST begin month.
			LastButOne	DST starts on the last but one configured weekday of the DST begin month.
			LastButTwo	DST starts on the last but two configured weekday of the DST begin month.
			LastButThree	DST starts on the last but three configured weekday of the DST begin month.
				<p><b>Notes</b></p> <p>This parameter is only displayed, if Daylight saving time (parameter 4591 ↗ p. 86) is set to "On".</p>
4593	DST begin month	2	1 to 12 [1]	<p>The month for the DST begin date is configured here.</p>
				<p><b>Example</b></p> <ul style="list-style-type: none"> <li>■ 1 = 1st month of the year</li> <li>■ 12 = 12th month of the year</li> </ul>
				<p><b>Notes</b></p> <p>This parameter is only displayed, if Daylight saving time (parameter 4591 ↗ p. 86) is set to "On".</p>
4597	DST end time	2	0 to 23 [0]	<p>The real-time clock will fall back by one hour when this time is reached on the DST end date</p>
				<p><b>Example</b></p> <ul style="list-style-type: none"> <li>■ 0 = 0th hour of the day (midnight).</li> <li>■ 23 = 23rd hour of the day (11 pm).</li> </ul>
				<p><b>Notes</b></p> <p>This parameter is only displayed, if Daylight saving time (parameter 4591 ↗ p. 86) is set to "On".</p>
4599	DST end weekday	2	Sunday to Saturday [Sunday]	<p>The weekday for the DST end date is configured here</p> <p><b>Notes</b></p> <p>This parameter is only displayed, if Daylight saving time (parameter 4591 ↗ p. 86) is set to "On".</p>

ID	Parameter	CL	Setting range [Default]	Description
4595	DST end nth. weekday	2		The order number of the weekday for the DST begin date is configured here.
			[1st]	DST ends on the 1st configured weekday of the DST begin month.
			2nd	DST ends on the 2nd configured weekday of the DST begin month.
			3rd	DST ends on the 3rd configured weekday of the DST begin month.
			4th	DST ends on the 4th configured weekday of the DST begin month.
			Last	DST ends on the last configured weekday of the DST begin month.
			LastButOne	DST ends on the last but one configured weekday of the DST begin month.
			LastButTwo	DST ends on the last but two configured weekday of the DST begin month.
			LastButThree	DST ends on the last but three configured weekday of the DST begin month.
				<b>Notes</b> This parameter is only displayed, if Daylight saving time (parameter 4591 ↗ p. 86) is set to "On".
4596	DST end month	2	1 to 12 [1]	The month for the DST begin date is configured here.
				<b>Example</b> ■ 1 = 1st month of the year ■ 12 = 12th month of the year
				<b>Notes</b> This parameter is only displayed, if Daylight saving time (parameter 4591 ↗ p. 86) is set to "On".

**Example**

If daylight saving time starts at 2:00 am on the 2nd Sunday in March and ends at 2:00 am on the 1st Sunday in November, the unit has to be configured like shown in ↗ *“Daylight saving time - configuration example” on page 88* to enable an automatic change to daylight saving time and back to standard time.

ID	Parameter	Setting
4591	Daylight saving time	On
4594	DST begin time	2
4598	DST begin weekday	Sunday
4592	DST begin nth weekday	2nd
4593	DST begin month	3
4597	DST end time	2
4599	DST end weekday	Sunday
4595	DST end sunday	1st
4596	DST end month	11

Table 29: Daylight saving time - configuration example



	USA, Canada		European Union	
Year	DST Begins 2 a.m. (Second Sunday in March)	DST Ends 2 a.m. (First Sunday in November)	DST Begins 1 a.m. UTC=GMT (Last Sunday in March)	DST Ends 1 a.m. UTC=GMT (Last Sunday in October)
2008	March 9, 2008	November 2, 2008	March 30, 2008	October 26, 2008
2009	March 8, 2009	November 1, 2009	March 29, 2009	October 25, 2009
2010	March 14, 2010	November 7, 2008	March 28, 2010	October 31, 2010

Table 30: Daylight saving time - exemplary dates

### 4.1.2 Configure Display

The contrast and the brightness of the display may be adjusted using this screen.

### 4.1.3 Lamp Test



*All lights on the controller may be tested for correct operation with this function.*

### 4.1.4 Enter Password

#### General notes

The controller utilizes a password protected multi-level configuration access hierarchy. This permits varying degrees of access to the parameters being granted by assigning unique passwords to designated personnel.

A distinction is made between the access levels as follows:

Code level	
Code level CL0 (User Level)  Standard password = none	<p>This code level permits for monitoring of the system and limited access to the parameters.</p> <p>Configuration of the control is not permitted.</p> <p>Only the parameters for setting the language, the date, the time, and the horn reset time are accessible.</p> <p>The unit powers up in this code level.</p>
Code level CL1 (Service Level)  Standard password = "0 0 1"	<p>This code level entitles the user to change selected non-critical parameters, such as setting the parameters accessible in CL0 plus Bar/PSI, °C/°F.</p> <p>The user may also change the password for level CL1.</p> <p>Access granted by this password expires two hours after the password has been entered and the user is returned to the CL0 level.</p>
Code level CL2 (Temporary Commissioning Level)  No standard password available	<p>This code level grants temporary access to most of the parameters. The password is calculated from the random number generated when the password is initially accessed.</p> <p>It is designed to grant a user one-time access to a parameter without having to give him a reusable password. The user may also change the password for level CL1.</p> <p>Access granted by this password expires two hours after the password has been entered and the user is returned to the CL0 level. The password for the temporary commissioning level may be obtained from the vendor.</p>
Code level CL3 (Commissioning Level)  Standard password = "0 0 3"	<p>This code level grants complete and total access to most of the parameters. In addition, the user may also change the passwords for levels CL1, CL2 and CL3.</p> <p>Access granted by this password expires two hours after the password has been entered and the user is returned to the CL0 level.</p>



*Once the code level is entered, access to the configuration menus will be permitted for two hours or until another password is entered into the control. If a user needs to exit a code level then code level, CL0 should be entered. This will block unauthorized configuration of the control.*

*A user may return to CL0 by allowing the entered password to expire after two hours or by changing any one digit on the random number generated on the password screen and entering it into the unit.*

*It is possible to disable expiration of the password by entering "0000" after the CL1 or CL3 password has been entered. Access to the entered code level will remain enabled until another password is entered. Otherwise, the code level would expire when loading the standard values (default 0000) via ToolKit.*

**Code level display**

The current code level is indicated by the lock symbol in the configuration menu screens. The lock symbol indicates the number of the code level and appears as "locked" (in code level CL0) or "unlocked" (in higher code levels).

Symbol	Status
	Locked
	Unlocked (Code Level 1)

ID	Parameter	CL	Setting range [Default]	Description
10400	Password display	0	0000 to 9999 [random number]	The password for configuring the control via the front panel must be entered here.
10405	Code level display	0	(display only) [0]	This value displays the code level, which is currently enabled for access via the front panel display.
10402	Password for CAN interface 1	0	0000 to 9999 [random number]	The password for configuring the control via the CAN interface #1 must be entered here.
10407	Code level CAN interface 1	0	(display only) [0]	This value displays the code level, which is currently enabled for access via the CAN interface #1.
10401	Password for serial interface 1	0	0000 to 9999 [random number]	The password for configuring the control via the serial interface #1 must be entered here.
10406	Code level serial interface 1	0	(display only) [0]	This value displays the code level, which is currently enabled for access via RS-232 serial interface #1.
10430	Password for serial interface 2	2	0000 to 9999 [random number]	The password for configuring the control via the serial interface #2 must be entered here.
10420	Code level serial interface 2	0	(display only) [0]	This value displays the code level, which is currently enabled for access via RS-485 serial interface #2.

### 4.1.5 System Management

ID	Parameter	CL	Setting range [Default]	Description
1702	Device number	2	1 to 32 [1]	A unique address is assigned to the control through this parameter. This unique address permits the controller to be correctly identified on the CAN bus. The address assigned to the controller may only be used once.  All other bus addresses are calculated on the number entered in this parameter.  The device number is also important for the device assignment in load sharing and load-dependent start/stop.
			<b>Notes</b>  The unit must be restarted after changing the device number to ensure proper operation.  For multiple genset applications please make sure to change parameter 8950 ↗ p. 353 as well	
4556	Configure display backlight	0	On	The display backlight is always enabled.
			[Key activate]	The display backlight will be dimmed, if no soft key is pressed for the time configured in parameter 4557 ↗ p. 92.
4557	Time until backlight shut-down	2	1 to 999 min [120 min]	If no soft key has been pressed for the time configured here, the display backlight will be dimmed.
			<b>Notes</b>  This parameter is only effective, if parameter 4556 ↗ p. 92 is configured to "Key activat.".	
14675	Black / white in color display	2	Yes	The display shows a black and white scheme.
			[No]	The display shows a color scheme.
10417	Factory default settings	0	Yes	The following three parameters are visible and restoring the configured parameters to factory default values is enabled.
			[No]	The following three parameters are invisible and restoring the configured parameters to factory default values is not enabled.
1701	Reset factory default values	0	Yes	All parameters, which the enabled access code grants privileges to, will be restored to factory default values.
			[No]	All parameters will remain as currently configured.
			<b>Notes</b>  This parameter is only displayed, if factory default settings (parameter 10417 ↗ p. 92/↗ p. 518) is set to "Yes".	
1844	Fast loading *.wset file	2	On	If the device is set to operation mode STOP and the generator does not run, the device can be switched via ToolKit into shutdown mode. The shutdown mode disables the display and other functions. This speeds up the *.wset-file loading.  After loading, the device automatically changes back into running mode.
			[Off]	The *.wset-file loading is executed in running mode.
			<b>Notes</b>  Be aware, that this would be also executed, if ToolKit acts over a modem connection.  If Fast loading parameter 1844 is "On" the firmware flashing requires the password level 2 or higher.	

ID	Parameter	CL	Setting range [Default]	Description
10500	Start Boot-loader	3	00000 [42405]	The bootloader is utilized for uploading application software only. The proper enable code must be entered while the control is in access code level CL3 or higher to perform this function.
				<p><b>Notes</b></p> <p>This parameter is only displayed, if factory default settings (parameter 10417 ↗ p. 92/↗ p. 518) is set to "Yes".</p> <p>This parameter is not available via ToolKit.</p> <p>This function is used for uploading application software and may only be used by authorized Woodward service personnel!</p>
1706	Clear eventlog	2	Yes	The event history will be cleared.
			[No]	The event history will not be cleared.
				<p><b>Notes</b></p> <p>This parameter is only displayed, if Factory Settings (parameter 10417 ↗ p. 92/↗ p. 518) is set to "Yes".</p> <p>This parameter is not available via ToolKit - the Event History can be cleared by pushing the button 'Clear All'.</p>

### 4.1.6 Password System

#### General notes



*The following passwords grant varying levels of access to the parameters.*

*Each individual password can be used to access the appropriate configuration level through multiple access methods and communication protocols (via the front panel, via serial RS-232/485 interface, and via the CAN bus).*

ID	Parameter	CL	Setting range [Default]	Description
10415	Basic code level	1	0 to 9999 [-]	The password for the code level "Service" is defined in this parameter. Refer to ↗ Chapter 4.1.4 "Enter Password" on page 89 for default values.
10413	Commissioning code level	3	0 to 9999 [-]	The password for the code level "Commission" is defined in this parameter. Refer to ↗ Chapter 4.1.4 "Enter Password" on page 89 for default values.
10414	Commissioning code level	3	0 to 9999 [-]	The algorithm for calculating the password for the code level "Temporary Commissioning" is defined in this parameter.
10412	Temp. supercomm. level code	5	0 to 9999 [-]	The algorithm for calculating the password for the code level "Temporary Supercommissioning" is defined in this parameter.
10411	Supercommissioning level code	5	0 to 9999 [-]	The password for the code level "Supercommissioning" is defined in this parameter. Refer to ↗ Chapter 4.1.4 "Enter Password" on page 89 for default values.

## 4.2 Configure Measurement

### General notes



If the easYgen is intended to be operated in parallel with the mains, the mains voltage measuring inputs must be connected.

### Dependencies

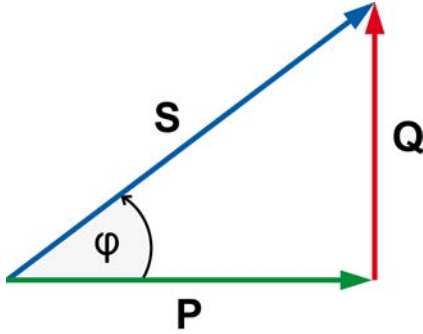

- PF Power Factor
- P Active Power [kW]
- S Apparent power [kVA]
- Q Reactive Power [kvar]

The AC power triangle illustrates the dependencies between active power, apparent power, reactive power and power factor.

- $PF = P/S = \cos \Phi$
- $Q = \sqrt{S^2 - P^2}$
- $S = \sqrt{P^2 + Q^2}$
- $P = S * PF$

Fig. 68: AC power triangle

ID	Parameter	CL	Setting range [Default]	Description
4103	Show mains data	2	[Yes]	Generator and mains data is displayed on the main operating values screen and the mains data screen is available.
			No	Only generator data is displayed on the main operating values screen. The mains data screen is disabled.  This setting may be recommended if the unit operates in an isolated application.
235	Generator type	2		The easYgen supports two types of generators: <ul style="list-style-type: none"> <li>■ synchronous generators</li> <li>■ asynchronous generators (induction generators)</li> </ul>
			[Synchronous]	The unit provides all functions which are needed for synchronous generator applications. Isolated and mains parallel operation is supported.
			Asynchronous	The unit provides the special function of the asynchronous generator with: <ul style="list-style-type: none"> <li>■ The speed is regulated with the speed signal from the MPU or J1939/CAN input (as long as the GCB is open).</li> <li>■ The closing of the GCB is executed, if the speed is within the corresponding frequency range of the generator operating window. The voltage and phase angle is ignored in this case.</li> <li>■ The generator monitoring (under/over frequency and under/overvoltage/asymmetry) is switched off, until the generator breaker is closed.</li> <li>■ After opening the GCB, under/over frequency and under/overvoltage and asymmetry monitoring is switched on again.</li> <li>■ The Frequency/MPU speed plausibility monitoring is only active, if the GCB is closed.</li> <li>■ The synchroscope is not displayed in the asynchronous modus.</li> </ul>
				<b>Notes</b> The asynchronous mode is used in slip synchronization only (Synchronization GCB (parameter 5729 ↗ p. 226) = Slip frequency.

ID	Parameter	CL	Setting range [Default]	Description
				<p><b>Recommended settings</b></p> <p>The asynchronous modus is normally used in mains parallel operation. Please consider the following settings:</p> <ul style="list-style-type: none"> <li>■ Application mode (parameter 3401 ↪ p. 222) = GCB</li> <li>■ MPU input (parameter 1600 ↪ p. 274) = On</li> <li>■ Generator operating frequency (parameter 5802 ↪ p. 110, 5803 ↪ p. 110)</li> </ul>
				<p><b>Notes</b></p> <p>The asynchron mode is not recommended for emergency power applications.</p>
1750	<b>System rated frequency</b>	2	50 / 60 Hz [50 Hz]	The rated frequency of the system is used as a reference figure for all frequency related functions, which use a percentage value, like frequency monitoring, breaker operation windows or the Analog Manager.
1601	<b>Engine rated speed</b>	2	500 to 4,000 rpm [1,500 rpm]	Number of revolutions per minute of the engine at rated engine speed. The speed control with an ECU via J1939 CAN bus refers to this value.
1766	<b>Generator rated voltage</b>	2	50 to 650000 V [400 V]	This value refers to the rated voltage of the generator (generator voltage on data plate) and is the voltage measured on the potential transformer primary.  The generator rated voltage is used as a reference figure for all generator voltage related functions, which use a percentage value, like generator voltage monitoring, breaker operation windows or the Analog Manager.
1768	<b>Mains rated voltage</b>	2	50 to 650000 V [400 V]	This value refers to the rated voltage of the mains and is the voltage measured on the potential transformer primary.  The mains potential transformer primary voltage is entered in this parameter. The mains rated voltage is used as a reference figure for all mains voltage related functions, which use a percentage value, like mains voltage monitoring, breaker operation windows or the Analog Manager.
1781	<b>Busbar 1 rated voltage</b>	2	50 to 650000 V [400 V]	This value refers to the rated voltage of busbar 1 and is the voltage measured on the potential transformer primary.  If voltage measuring is configured to 1Ph 3W, the WYE voltage (VL1N) must be entered here.  The busbar 1 potential transformer primary voltage is entered in this parameter. The busbar rated voltage is used as a reference figure for all busbar voltage related functions, which use a percentage value, like synchronization.
1752	<b>Gen. rated active power [kW]</b>	2	0.5 to 99999.9 kW [200.0 kW]	This value specifies the generator real power rating, which is used as a reference figure for related functions. The generator rated active power is the generator apparent power multiplied by the generator power factor (typically ~0.8). These values are indicated in the generator data plate ( ↪ "Dependencies" on page 94).
1758	<b>Gen. rated react. power [kvar]</b>	2	0.5 to 99999.9 kvar [200.0 kvar]	This value specifies the generator reactive power rating, which is used as a reference figure for related functions. The generator rated reactive power also depends on the generator values ( ↪ "Dependencies" on page 94).
1754	<b>Generator rated current</b>	2	1 to 32000 A [300 A]	This value specifies the generator rated current, which is used as a reference figure for related functions.
1748	<b>Mains rated active power [kW]</b>	2	0.5 to 99999.9 kW [200.0 kW]	This value specifies the mains real power rating, which is used as a reference figure for related functions. The mains rated active power is a reference value used by several monitoring and control functions ( ↪ "Dependencies" on page 94).

## Configuration

### Configure Measurement

ID	Parameter	CL	Setting range [Default]	Description
1746	Mains rated react. pwr. [kvar]	2	0.5 to 99999.9 kvar [200.0 kvar]	This value specifies the mains reactive power rating, which is used as a reference figure for related functions.  The mains rated reactive power is a reference value used by several monitoring and control functions( ↪ "Dependencies" on page 94).
1785	Mains rated current	2	5 to 32000 A [300 A]	This value specifies the mains rated current, which is used as a reference figure for related functions.
1825	System rated active power [kW]	2	0.5 to 99999.9 [200.0 kW]	This value specifies 100 % of the system rated power, which is used for system related indications and calculations.  The Analog Manager 00.11 "System active nominal power" and 00.12 "System total real power are related to this value or setting.
1858	1Ph2W voltage measuring	3	[Phase - phase]	The unit is configured for measuring phase-phase voltages if 1Ph 2W measuring is selected.
			Phase - neutral	The unit is configured for measuring phase-neutral voltages if 1Ph 2W measuring is selected.
			<b>Notes</b> For information on measuring principles refer to ↪ Chapter 3.3.5.1 "Generator Voltage" on page 47.  Never configure the busbar measurement for phase-neutral, if the other systems like mains and generator are configured as 3Ph 3W or 3Ph 4W. The phase angle for synchronization would be not correct.	
1859	1Ph2W phase rotation	3	[CW]	A clockwise rotation field is considered for 1Ph 2W measuring .
			CCW	A counter-clockwise rotation field is considered for 1Ph 2W measuring.
			<b>Notes</b> For information on measuring principles refer to ↪ Chapter 3.3.5.1 "Generator Voltage" on page 47.	
1851	Generator voltage measuring	2	3Ph 4W OD	Measurement is performed Line-Neutral (Open Delta connected system). The voltage is connected via transformer with 3 Wire.  Phase voltages and the neutral must be connected for proper calculation.  Measurement, display and protection are adjusted according to the rules for Open Delta connected systems.  Monitoring refers to the following voltages:  ■ VL12, VL23 and VL31
			1Ph 3W	Measurement is performed Line-Neutral (WYE connected system) and Line-Line (Delta connected system). The protection depends on the setting of parameter 1770 ↪ p. 109.  Measurement, display, and protection are adjusted according to the rules for single-phase systems.  Monitoring refers to the following voltages:  ■ VL13 (parameter 1770 ↪ p. 109 configured to "Phase-phase") ■ VL1N, VL3N (parameter 1770 ↪ p. 109 configured to "Phase-neutral")



ID	Parameter	CL	Setting range [Default]	Description
			1Ph 2W	<p>Measurement is performed Line-Neutral (WYE connected system) if parameter 1858 <a href="#">↪ p. 96</a> is configured to "Phase - neutral" and Line-Line (Delta connected system) if parameter 1858 <a href="#">↪ p. 96</a> is configured to "Phase - phase".</p> <p>Measurement, display and protection are adjusted according to the rules for phase-phase systems.</p> <p>Monitoring refers to the following voltages:</p> <ul style="list-style-type: none"> <li>■ VL1N, VL12</li> </ul>
			3Ph 3W	<p>Measurement is performed Line-Line (Delta connected system). Phase voltages must be connected for proper calculation.</p> <p>Measurement, display and protection are adjusted according to the rules for Delta connected systems.</p> <p>Monitoring refers to the following voltages:</p> <ul style="list-style-type: none"> <li>■ VL12, VL23, VL31</li> </ul>
			[3Ph 4W]	<p>Measurement is performed Line-Neutral (WYE connected system) and Line-Line (Delta connected system). The protection depends on the setting of parameter 1770 <a href="#">↪ p. 109</a>.</p> <p>Phase voltages and the neutral must be connected for proper calculation. Measurement, display and protection are adjusted according to the rules for WYE connected systems.</p> <p>Monitoring refers to the following voltages:</p> <ul style="list-style-type: none"> <li>■ VL12, VL23 and VL31 (parameter 1770 <a href="#">↪ p. 109</a> configured to "Phase-phase")</li> <li>■ VL1N, VL2N and VL3N (parameter 1770 <a href="#">↪ p. 109</a> configured to "Phase-neutral")</li> </ul>
				<p><b>Notes</b></p> <p>If this parameter is configured to 1Ph 3W, the generator and mains rated voltages (parameters 1766 <a href="#">↪ p. 95</a> and 1768 <a href="#">↪ p. 95</a>) must be entered as Line-Line (Delta) and the busbar 1 rated voltage (parameter 1781 <a href="#">↪ p. 95</a>) must be entered as Line-Neutral (WYE).</p> <p>For information on measuring principles refer to <a href="#">↪ Chapter 3.3.5.1 "Generator Voltage" on page 47.</a></p>
1850	Generator current measuring	2	[L1 L2 L3 ]	<p>All three phases are monitored. Measurement, display and protection are adjusted according to the rules for 3-phase measurement. Monitoring refers to the following currents: IL1, IL2, IL3</p>
			Phase L{1/2/3}	<p>Only one phase is monitored. Measurement, display and protection are adjusted according to the rules for single-phase measurement.</p> <p>Monitoring refers to the selected phase.</p>
				<p><b>Notes</b></p> <p>This parameter is only effective if generator voltage measuring (parameter 1851 <a href="#">↪ p. 96</a>) is configured to "3Ph 4W" or "3Ph 3W".</p> <p>For information on measuring principles refer to <a href="#">↪ Chapter 3.3.6.1 "Generator Current" on page 64.</a></p>

ID	Parameter	CL	Setting range [Default]	Description
1853	<b>Mains voltage measuring</b>	2	<b>[3Ph 4W]</b>	<p>Measurement is performed Line-Neutral (WYE connected system) and Line-Line (Delta connected system). The protection depends on the setting of parameter 1771 ↗ p. 139.</p> <p>Phase voltages and the neutral must be connected for proper calculation. Measurement, display and protection are adjusted according to the rules for WYE connected systems.</p> <p>Monitoring refers to the following voltages:</p> <ul style="list-style-type: none"> <li>■ VL12, VL23 and VL31 (parameter 1771 ↗ p. 139 configured to "Phase-phase")</li> <li>■ VL1N, VL2N and VL3N (parameter 1771 ↗ p. 139 configured to "Phase-neutral")</li> <li>■ VL12, VL23, VL31, VL1N, VL2N and VL3N (parameter 1771 ↗ p. 139 configured to "All")</li> </ul>
			3Ph 3W	<p>Measurement is performed Line-Line (Delta connected system). Phase voltages must be connected for proper calculation.</p> <p>Measurement, display and protection are adjusted according to the rules for Delta connected systems.</p> <p>Monitoring refers to the following voltages:</p> <ul style="list-style-type: none"> <li>■ VL12, VL23, VL31</li> </ul>
			1Ph 2W	<p>Measurement is performed Line-Neutral (WYE connected system) if parameter 1858 ↗ p. 96 is configured to "Phase - neutral" and Line-Line (Delta connected system) if parameter 1858 ↗ p. 96 is configured to "Phase - phase".</p> <p>Measurement, display and protection are adjusted according to the rules for phase-phase systems.</p> <p>Monitoring refers to the following voltages:</p> <ul style="list-style-type: none"> <li>■ VL1N, VL12</li> </ul>
			1Ph 3W	<p>Measurement is performed Line-Neutral (WYE connected system) and Line-Line (Delta connected system).</p> <p>The protection depends on the setting of parameter 1771 ↗ p. 139. Measurement, display, and protection are adjusted according to the rules for single-phase systems.</p> <p>Monitoring refers to the following voltages:</p> <ul style="list-style-type: none"> <li>■ VL13 (parameter 1771 ↗ p. 139 configured to "Phase-phase")</li> <li>■ VL1N, VL3N (parameter 1771 ↗ p. 139 configured to "Phase-neutral")</li> <li>■ VL1N, VL3N (parameter 1771 ↗ p. 139 configured to "All")</li> </ul>
				<p><b>Notes</b></p> <p>If this parameter is configured to 1Ph 3W, the generator and mains rated voltages (parameters 1766 ↗ p. 95 and 1768 ↗ p. 95) must be entered as Line-Line (Delta) and the busbar 1 rated voltage (parameter 1781 ↗ p. 95) must be entered as Line-Neutral (WYE).</p>
1854	<b>Mains current input</b>	2	<b>[Mains current]</b> / Ground current / Off	This parameter configures whether ground or mains current is measured on terminals 1/2 or the input is disabled.

ID	Parameter	CL	Setting range [Default]	Description
1852	<b>Mains current measuring</b>	2	[Phase L1] / Phase L2 / Phase L3	Phase L{1/2/3} Measurement is performed for the selected phase only. The measurement and display refer to the selected phase.  The configured phase CT must be connected to perform current measurement.
				<b>Notes</b>  For information on measuring principles refer to <a href="#">Chapter 3.3.6.2 "Mains Current" on page 66.</a>  This parameter is only effective if mains voltage measuring (parameter 1853 <a href="#">p. 98</a> ) is configured to "3Ph 4W" or "3Ph 3W".

### 4.2.1 Configure Transformer

#### General notes

The setpoints for specific parameters will differ depending upon the hardware version, indicated on the data plate.

- [1] easYgen-3xxx-1 = Current transformer with ../1 A rated current
- [5] easYgen-3xxx-5 = Current transformer with ../5 A rated current

ID	Parameter	CL	Setting range [Default]	Description
1801	<b>Gen. PT primary rated voltage</b>  (Generator potential transformer primary voltage rating)	2	50 to 650000 V  [400 V]	Some generator applications may require the use of potential transformers to facilitate measuring the voltages produced by the generator. The rating of the primary side of the potential transformer must be entered into this parameter.  If the generator application does not require potential transformers (i.e. the generated voltage is 480 V or less), then the generated voltage will be entered into this parameter.
1800	<b>Gen. PT secondary rated volt.</b>  (Generator potential transformer secondary voltage rating )	2	50 to 480 V  [400 V]	Some generator applications may require the use of potential transformers to facilitate measuring the voltages produced by the generator. The rating of the secondary side of the potential transformer must be entered into this parameter.  If the generator application does not require potential transformers (i.e. the generated voltage is 480 V or less), then the generated voltage will be entered into this parameter.  <ul style="list-style-type: none"> <li>■ Rated voltage: 120 Vac (this parameter configured between 50 and 130 V) Generator voltage: Terminals 29/31/33/35</li> <li>■ Rated voltage: 480 Vac (this parameter configured between 131 and 480 V) Generator voltage: Terminals 30/32/34/36</li> </ul>

## Configuration

Configure Measurement > Configure Transformer

ID	Parameter	CL	Setting range [Default]	Description
				<p><b>Notes</b></p> <p>WARNING: Only connect the measured voltage to either the 120 Vac or the 480 Vac inputs. Do not connect both sets of inputs to the measured system.</p> <p>The control unit is equipped with dual voltage measuring inputs. The voltage range of these measurement inputs is dependent upon input terminals are used. This value refers to the secondary voltages of the potential transformers, which are directly connected to the control unit.</p>
1806	<p><b>Gen. CT primary rated current</b></p> <p>(Generator current transformer primary rating)</p>	2	<p>1 to 32000 A/x</p> <p>[500 A/x]</p>	<p>The input of the current transformer ratio is necessary for the indication and control of the actual monitored value.</p> <p>The current transformers ratio should be selected so that at least 60 % of the secondary current rating can be measured when the monitored system is at 100 % of operating capacity (i.e. at 100 % of system capacity a 5 A CT should output 3 A).</p> <p>If the current transformers are sized so that the percentage of the output is lower, the loss of resolution may cause inaccuracies in the monitoring and control functions and affect the functionality of the control.</p>
1813	<p><b>Busb1 PT primary rated voltage</b></p> <p>(Busbar 1 potential transformer primary voltage rating )</p>	2	<p>50 to 650000 V</p> <p>[400 V]</p>	<p>Some applications may require the use of potential transformers to facilitate measuring the voltages to be monitored. The rating of the primary side of the potential transformer must be entered into this parameter.</p> <p><b>Notes</b></p> <p>If the application does not require potential transformers (i.e. the measured voltage is 480 V or less), then the measured voltage will be entered into this parameter.</p>
1812	<p><b>Busb1 PT secondary rated volt.</b></p> <p>(Busbar 1 potential transformer secondary voltage rating )</p>	2	<p>50 to 480 V</p> <p>[400 V]</p>	<p>Some applications may require the use of potential transformers to facilitate measuring the busbar voltages. The rating of the secondary side of the potential transformer must be entered into this parameter.</p> <p>If the application does not require potential transformers (i.e. the measured voltage is 480 V or less), then the measured voltage will be entered into this parameter.</p> <ul style="list-style-type: none"> <li>■ Rated voltage: 120 Vac (this parameter configured between 50 and 130 V) Busbar voltage: Terminals 37/39</li> <li>■ Rated voltage: 480 Vac (this parameter configured between 131 and 480 V) Busbar voltage: Terminals 38/40</li> </ul> <p><b>Notes</b></p> <p>WARNING: Only connect the measured voltage to either the 120 Vac or the 480 Vac inputs. Do not connect both sets of inputs to the measured system.</p> <p>The control is equipped with dual voltage measuring inputs. The voltage range of these measurement inputs is dependent upon input terminals are used. This value refers to the secondary voltages of the potential transformers, which are directly connected to the control.</p>
1804	<p><b>Mains PT primary rated voltage</b></p> <p>(Mains potential transformer primary voltage rating)</p>	2	<p>50 to 650000 V</p> <p>[400 V]</p>	<p>Some applications may require the use of potential transformers to facilitate measuring the voltages to be monitored. The rating of the primary side of the potential transformer must be entered into this parameter.</p> <p><b>Notes</b></p> <p>If the application does not require potential transformers (i.e. the measured voltage is 480 V or less), then the measured voltage will be entered into this parameter.</p>

ID	Parameter	CL	Setting range [Default]	Description
1803	<b>Mains PT secondary rated volt.</b>  (Mains potential transformer secondary voltage rating)	2	50 to 480 V  [400 V]	Some applications may require the use of potential transformers to facilitate measuring the mains voltages. The rating of the secondary side of the potential transformer must be entered into this parameter.  If the application does not require potential transformers (i.e. the measured voltage is 480 V or less), then the measured voltage will be entered into this parameter.  <ul style="list-style-type: none"> <li>■ Rated voltage: 120 Vac (this parameter configured between 50 and 130 V) Mains voltage: Terminals 21/23/25/27</li> <li>■ Rated voltage: 480 Vac (this parameter configured between 131 and 480 V) Mains Voltage: Terminals 22/24/26/28</li> </ul>
			<b>Notes</b>  WARNING: Only connect the measured voltage to either the 120 Vac or the 480 Vac inputs. Do not connect both sets of inputs to the measured system.  The control is equipped with dual voltage measuring inputs. The voltage range of these measurement inputs is dependent upon input terminals are used. This value refers to the secondary voltages of the potential transformers, which are directly connected to the control.	
1807	<b>Mains CT primary rated current</b>  (Mains current transformer primary rating)	2	1 to 32000 A/x  [500 A/x]	The input of the current transformer ratio is necessary for the indication and control of the actual monitored value.  The current transformers ratio should be selected so that at least 60 % of the secondary current rating can be measured when the monitored system is at 100 % of operating capacity (i.e. at 100 % of system capacity a 5 A CT should output 3 A).  If the current transformers are sized so that the percentage of the output is lower, the loss of resolution may cause inaccuracies in the monitoring and control functions and affect the functionality of the control.
			<b>Notes</b>  This screen is only visible if parameter 1854 ↪ p. 98 is configured as Mains.	
1810	<b>Gnd. CT primary rated current</b>  (Ground current transformer primary rating)	2	1 to 32000 A/x  [500 A/x]	The input of the current transformer ratio is necessary for the indication and control of the actual monitored value.  The current transformers ratio should be selected so that at least 60 % of the secondary current rating can be measured when the monitored system is at 100 % of operating capacity (i.e. at 100 % of system capacity a 5 A CT should output 3 A).  If the current transformers are sized so that the percentage of the output is lower, the loss of resolution may cause inaccuracies in the monitoring and control functions and affect the functionality of the control.
			<b>Notes</b>  This screen is only visible if parameter 1854 ↪ p. 98 is configured as Ground.	

### 4.2.2 External Mains Active Power

ID	Parameter	CL	Setting range [Default]	Description
2966	<b>External mains active power</b>	2	Yes	<p>The mains active power is coming from an external source.</p> <p>The following measurement values of the external mains active power depend on the external mains <b>reactive</b> power measurement. So there is to differentiate between two cases:</p> <p><b>Case 1:</b> External mains <b>reactive</b> power measurement (parameter 2969 ↗ p. 103) is disabled:</p> <ul style="list-style-type: none"> <li>■ The mains power factor is assumed as "1".</li> <li>■ The mains power factor monitoring is switched off.</li> <li>■ The mains power factor is not displayed.</li> <li>■ The mains total reactive power is not displayed.</li> </ul> <p><b>Case 2:</b> External mains <b>reactive</b> power measurement (parameter 2969 ↗ p. 103) is enabled:</p> <ul style="list-style-type: none"> <li>■ The mains power factor is calculated.</li> <li>■ The mains power factor monitoring is switched off.</li> <li>■ The mains power factor is not displayed.</li> <li>■ The mains total reactive power is not displayed.</li> <li>■ The mains total apparent power is calculated and displayed.</li> </ul> <p><b>Notes</b></p> <p>Mains power monitoring is not available.</p> <p>Please make sure to assign the external mains active power to the corresponding analog data source (parameter 5780 ↗ p. 102). The same data source must be used if the mains active power is requested via interface.</p>
			[No]	The mains active power is internally measured.
5780	<b>Data source</b>	2	Determined by AnalogManager <b>[06.01 Analog input 1]</b>	Typically an analog input is selected as data source which is connected to an external transducer.
2967	<b>Mains power meas. resolution</b>  (Mains power measurement resolution)	2		This parameter controls the resolution and the format.
			Selected resolution	Power at 100 % analog value
			0.01 kW	10.00 kW
			0.1 kW	100.0 kW
			<b>[1 kW]</b>	1000 kW
			0.01 MW	10.00 MW
			0.1 MW	100.0 MW

### 4.2.3 External Mains Reactive Power

ID	Parameter	CL	Setting range [Default]	Description
2969	<b>External mains reactive power</b>	2	Yes	<p>The mains reactive power is coming from an external source. This power is displayed and used for control purposes. The source is taken via Analog-Manager.</p> <p>The following measurement values depend on the external mains active power measurement. So there is to differentiate between two cases:</p> <p><b>Case 2:</b> External mains <b>active</b> power measurement (parameter 2966 ↗ p. 102) is disabled:</p> <ul style="list-style-type: none"> <li>■ The mains power factor is assumed as "1".</li> <li>■ The mains active power monitoring is switched off.</li> <li>■ The mains power factor monitoring is switched off.</li> <li>■ The mains power factor is not displayed.</li> <li>■ The mains total active power is not displayed.</li> </ul> <p><b>Case 1:</b> External mains <b>active</b> power measurement (parameter <b>2966</b>) is enabled:</p> <ul style="list-style-type: none"> <li>■ The mains power factor is calculated.</li> <li>■ The mains power factor monitoring is switched off.</li> <li>■ The mains power factor is not displayed.</li> <li>■ The mains total reactive power is not displayed.</li> <li>■ The mains total apparent power is calculated and displayed.</li> </ul> <p><b>Notes</b></p> <p>Mains power monitoring is not available.</p> <p>Please make sure to assign the external mains reactive power to the corresponding analog data source (parameter 5794 ↗ p. 103). The same data source must be used if the mains active power is requested via interface.</p>
			[No]	The mains reactive power is internally measured.
5794	<b>Data source</b>	2	Determined by AnalogManager <b>[06.02 Analog input 2]</b>	Typically an analog input is selected as data source (kvar value) which is connected to an external transducer.
2970	<b>Mains react. power meas. resolution</b>  (Mains reactive power measurement resolution)	2		This parameter controls the resolution and the format.
			Selected resolution:	Power at 100 % analog value:
			0.01 kvar	10.00 kvar
			0.1 kW	100.0 kvar
			<b>[1 kvar]</b>	1000 kvar
			0.01 Mvar	10.00 Mvar
0.1 Mvar	100.0 Mvar			

## 4.3 Function Of Inputs And Outputs

### 4.3.1 Discrete Inputs

The discrete inputs may be grouped into two categories:

- Programmable
  - The discrete input has been assigned a default function using either the LogicsManager or preconfigured alarms such as "emergency stop".
  - The following sections describe how these functions are assigned.
  - The function of a discrete input can be changed if required.
  - The following description of the inputs, labeled with "programmable", refers to the preconfiguration.
- Fixed
  - The discrete input has a specific function that cannot be changed depending upon the configured application mode.

Input	Type/Preset	Description
Discrete input [DI 01]	Programmable Preconfigured to "Emergency stop"	This discrete input is configured as alarm class F and is not delayed by the engine speed.
Discrete input [DI 02]	Programmable Preconfigured to "Start in AUTO"	Enabled in the AUTOMATIC operation mode  This discrete input is configured as a Control input in the alarm class and is not delayed by the engine speed. <ul style="list-style-type: none"> <li>■ <b>Energized</b> If the unit is in the AUTOMATIC operation mode (selected with the operating mode selection push button on the front panel) the controlled engine is started automatically.</li> <li>■ <b>De-energized</b> The engine is stopped.</li> </ul>
Discrete input [DI 03]	Programmable Preconfigured to "Low oil pressure"	This discrete input is configured as alarm class B and is delayed by the engine speed.
Discrete input [DI 04]	Programmable Preconfigured to "Coolant temperature"	This discrete input is configured as alarm class B and is not delayed by the engine speed.
Discrete input [DI 05]	Programmable Preconfigured to "Alarm acknowledge"	This discrete input is used as a remote acknowledgement for alarms. The input is normally de-energized. When an alarm is to be acknowledged the input is energized. The first time an alarm is acknowledged, the centralized alarm/horn is silenced. When the input is energized a second time, all alarms, which are no longer active, will be acknowledged.  This discrete input is configured as a Control input in the alarm class and is not delayed by the engine speed.
Discrete input [DI 06]	Programmable Preconfigured to "Enable MCB"	Only applicable for application mode <b>A04</b>  This discrete input is configured as a Control input in the alarm class and is not delayed by the engine speed. <ul style="list-style-type: none"> <li>■ <b>Energized</b> The MCB is enabled and closure of the breaker is permitted.</li> <li>■ <b>De-energized</b> The MCB is not enabled and closure of the breaker is not permitted. This function permits a supervisory control (i.e. a PLC) to allow the closure of the MCB by the easYgen.</li> </ul>



Input	Type/Preset	Description
Discrete input [DI 07]	Fixed to "Reply: MCB open"	<p>Only applicable for application mode <b>A04</b></p> <p>This input implements negative function logic.</p> <p>The controller utilizes the CB auxiliary (B) contacts into this discrete input to reflect the state of the MCB.</p> <p>This discrete input must be energized to show when the breaker is open and de-energized to show when the MCB is closed. The status of the MCB is displayed on the screen.</p> <p>This input is usually used in all breaker modes to change between frequency/voltage and power/power factor control (refer to note below).</p>
Discrete input [DI 08]	Fixed to "Reply: GCB open"	<p>Only applicable for application modes <b>A03</b> and <b>A04</b></p> <p>This input implements negative function logic.</p> <p>The controller utilizes the CB auxiliary (B) contacts into this discrete input to reflect the state of the GCB. This discrete input must be energized to show when the breaker is open and de-energized to show when the GCB is closed. The status of the GCB is displayed on the screen.</p> <p>This input is usually used in all breaker modes to enable reverse power protection, overload MOP protection, mains decoupling and the activation of the load sharing (refer to note below).</p>



*The easYgen usually decides whether it performs voltage and frequency (V/f) control or power and power factor (P/PF) control using the reply of the circuit breakers, i.e. the discrete inputs DI 7 and DI 8.*

- *If the GCB is open, only V/f control is performed*
- *If the GCB is closed and the MCB is open, V/f control as well as active and reactive power load sharing is performed*
- *If the GCB is closed and the MCB is closed, P/PF control or import power control with load sharing and PF control is performed.*

*A different configuration is possible and depends on the following LogicsManager (parameter 12940 ↪ p. 314 and parameter 12941 ↪ p. 333)*



**Alarm inputs**

*All discrete inputs, which are not assigned a function, can be used as alarm or control inputs. These discrete inputs can be freely configured as such ( ↪ Chapter 4.5.3 "Discrete Inputs" on page 246).*

### 4.3.2 Discrete Outputs

- Programmable
  - The discrete output has been assigned a default function using the LogicsManager.
  - The following text describes how these functions are assigned using the LogicsManager.
  - It is possible to change the function of the discrete output if required.
  - The following description of the outputs, labeled with "programmable", refers to the preconfiguration.
- Fixed
  - The discrete output has a specific function that cannot be changed depending upon the configured application mode.
  - The discrete output cannot be viewed or changed in the LogicsManager.
  - However, the discrete output may be programmable in some application modes.



*The discrete outputs can be "programmable" or "fixed" depending on the application mode (parameter 3401 ↗ p. 222).*

*For information on the function of the discrete outputs depending on the configured application mode refer to ↗ Chapter 4.5.5 "Discrete Outputs (LogicsManager)" on page 251.*



#### **CAUTION!**

##### **Uncontrolled operation due to faulty configuration**

The discrete output "Ready for operation OFF" must be wired in series with an emergency stop function.

This means that it must be ensured that the generator circuit breaker is opened and the engine is stopped if this discrete output is de-energized.

If the availability of the plant is important, this fault must be signaled independently from the unit.



**CAUTION!**

**Uncontrolled operation due to unknown configuration**

The circuit breaker commands must be checked before every commissioning because the relays can be used for different applications and can be assigned to various functions.

- Make sure that all relay outputs are configured correctly.

Output	Type/Preset	Description
Relay output [R 01]	Programmable Fixed to "Ready for operation"  <b>CAUTION!</b> Only relay [R 01] has an inverse logic. The relay opens (all other relays close), if the logical output of the LogicsManager becomes TRUE.	This discrete output is used to ensure that the internal functions of the controller are operating properly.  It is possible to configure additional events, which cause the contacts of this discrete output to open, using the LogicsManager.
Relay output [R 02]	Programmable Preconfigured to "Centralized alarm (horn)"	When a centralized alarm is issued, this discrete output is enabled.  A horn or a buzzer maybe activated via this discrete output. Pressing the button next to the "✓" symbol will acknowledge the centralized alarm and disable this discrete output.  The discrete output will re-enable if a new fault condition resulting in a centralized alarm occurs. The centralized alarm is initiated by class B alarms or higher.
Relay output [R 03]	Programmable Preconfigured to "Starter"	The generator starting circuit is engaged when this discrete output is enabled.  This discrete output will enable depending on the start sequence (refer to the start sequence description in <a href="#">Chapter 4.5.9.1 "Engine Type" on page 260</a> ) to energize the starter for the configured starter time (parameter 3306 <a href="#">p. 269</a> ).
Relay output [R 04]	Programmable Preconfigured to "Fuel solenoid / gas valve"	<p><b>Fuel solenoid</b></p> The fuel solenoid for the diesel engine is energized when this discrete output is enabled. If the engine is given a stop command or engine speed drops below the configured firing speed, this discrete output is disabled immediately.
		<p><b>Gas valve</b></p> The gas valve for the engine is energized when this discrete output is enabled. If the engine is given a stop command or engine speed drops below the configured firing speed, this discrete output is disabled immediately.

Output	Type/Preset	Description
Relay output [R 05]	Programmable Preconfigured to "Preglow"	<p><b>Preglow</b></p> <p>When this discrete output is enabled, the diesel engine's glow plugs are energized (refer to <a href="#">Chapter 4.5.9.1 "Engine Type" on page 260</a>). This function only occurs if the control has been configured for diesel engine start/stop logic.</p> <p><b>Ignition</b></p> <p>When this discrete output is enabled, the gas engine's ignition is enabled (refer to <a href="#">Chapter 4.5.9.1 "Engine Type" on page 260</a>). This function only occurs if the control has been configured for gas engine start/stop logic.</p>
Relay output [R 06]	Programmable Preconfigured to "Command: close GCB"	<p>Only applicable for application modes <b>A03</b> and <b>A04</b>.</p> <p>The "Command: close GCB" output issues the signal for the GCB to close. This relay may be configured as an impulse or constant output signal depending on parameter 3414 <a href="#">p. 225</a>.</p> <p><b>Impulse</b></p> <p>If the output is configured as "Impulse", the discrete output will enable for the time configured in parameter 3416 <a href="#">p. 226</a>. An external holding coil and sealing contacts must be installed into the GCB closing circuit if this discrete output is configured for an impulse output signal.</p> <p><b>Constant</b></p> <p>If the relay is configured as "Constant", the relay will energize and remain enabled as long as the discrete input "Reply GCB" remains de-energized and the generator and busbar voltages are identical. If a class C or higher alarm occurs, this discrete will disable and the GCB will open immediately.</p>
Relay output [R 07]	Programmable Preconfigured to "Command: open GCB"	<p>Not applicable for application mode <b>A01</b></p> <p>The parameter 3403 <a href="#">p. 225</a> defines how this relay functions.</p> <p>If this output is configured as "N.O.", the relay contacts close resulting in the GCB opening circuit energizing.</p> <p>If this output is configured as "N.C.", the relay contacts open resulting in the GCB opening circuit de-energizing.</p> <p>If the controller is configured for the breaker application "None", this relay is freely configurable.</p> <p><b>Application mode <b>A02</b></b></p> <p>The open GCB command remains enabled until the GCB is manually closed and the discrete input "Reply GCB" is energized. The open GCB command will be issued when a fault condition or an engine shut down occurs.</p> <p><b>Application mode <b>A03</b> or <b>A04</b></b></p> <p>The controller enables the open GCB command when the GCB is to be opened for switching operations. If the discrete input "Reply GCB" is energized, the open GCB command will be disabled.</p>

Output	Type/Preset	Description
Relay output [R 08]	Programmable Preconfigured to "Command: close MCB"	Only applicable for application mode <b>A04</b> . The discrete output "Command: close MCB" is an impulse output signal. This discrete output is enabled for the time configured in parameter 3417 ↗ p. 229. An external holding coil and sealing contacts must be utilized with the MCB closing circuit.
Relay output [R 09]	Programmable Preconfigured to "Command: open MCB"	Only applicable for application mode <b>A04</b> . The controller enables this discrete output when the MCB is to be opened for switching operations. If the discrete input "Reply MCB" is energized, the discrete output "Command: open MCB" is disabled.
Relay output [R 10]	Programmable Preconfigured to "Auxiliary services"	The auxiliary services output (LogicsManager 03.01) will be enabled with the start command (prior to the engine start because of the prerun time) and remains enabled as long as the engine is running. It will be disabled after the engine has stopped and the postrun time has expired (i.e. for operating a cooling pump). ↗ "Auxiliary operations" on page 269 for this behavior. The auxiliary services output (LogicsManager 03.01) is always enabled in MANUAL operation mode.
Relay output [R 11]	Programmable Preconfigured to "Alarm class A and B"	This discrete output is enabled when a warning alarm (class A or B alarm) is issued ( ↗ Chapter 9.5.1 "Alarm Classes" on page 733). After all warning alarms have been acknowledged, this discrete output will disable.
Relay output [R 12]	Programmable Preconfigured to "Alarm class C, D, E or F"	This discrete output is enabled when a shutdown alarm (class C or higher alarm; refer to ↗ Chapter 9.5.1 "Alarm Classes" on page 733 for more information) is issued. After all shutdown alarms have been acknowledged, this discrete output will disable.
LogicsManager Relay		All discrete outputs not assigned a defined function, may be freely configured via the LogicsManager.

## 4.4 Configure Monitoring

### 4.4.1 Generator

ID	Parameter	CL	Setting range [Default]	Description
1770	Generator voltage monitoring	2		The unit can either monitor the phase-neutral (wye) voltages or the phase-phase (delta) voltages. If the controller is used in a compensated or isolated network, voltage protection monitoring should be configured as phase-neutral to prevent earth-faults resulting in tripping of the voltage protections.
			[Phase - phase]	The phase-phase voltage will be monitored and all subsequent parameters concerning voltage monitoring "generator" are referred to this value (VL-L).

ID	Parameter	CL	Setting range [Default]	Description
			Phase - neutral	The phase-neutral voltage will be monitored and all subsequent parameters concerning voltage monitoring "generator" are referred to this value (VL-N).
				<b>Notes</b> WARNING: This parameter defines how the protective functions operate.

4.4.1.1 Generator Operating Voltage / Frequency



*The operating voltage/frequency parameters are used to check if the values are in range when performing a dead bus closure and synchronization of the generator. Busbar 1 must be within this ranges to synchronize the generator to the busbar.*

*It is recommended to configure the operating limits within the monitoring limits.*

ID	Parameter	CL	Setting range [Default]	Description
5800	<b>Upper voltage limit</b> (Generator maximum operating voltage limit)	2	100 to 150% <b>[110%]</b> (Hysteresis: 1%)	The maximum permissible positive deviation of the generator voltage from the generator rated voltage (parameter 1766 ↪ p. 95) is configured here.  This value may be used as a voltage limit switch. The conditional state of this switch may be used as a command variable for the LogicsManager (02.03).
5801	<b>Lower voltage limit</b> (Generator minimum operating voltage limit)	2	50 to 100% <b>[90%]</b> (Hysteresis: 1%)	The maximum permissible negative deviation of the generator voltage from the generator rated voltage (parameter 1766 ↪ p. 95) is configured here.  This value may be used as a voltage limit switch. The conditional state of this switch may be used as a command variable for the LogicsManager (02.03).
5802	<b>Upper frequency limit</b> (Generator maximum operating frequency limit)	2	100.0 to 150.0% <b>[105.0%]</b> (Hysteresis: 0.05%)	The maximum permissible positive deviation of the generator frequency from the rated system frequency (parameter 1750 ↪ p. 95) is configured here.  This value may be used as a frequency limit switch. The conditional state of this switch may be used as a command variable for the LogicsManager (02.04).
5803	<b>Lower frequency limit</b> (Generator minimum operating frequency limit)	2	50.0 to 100.0% <b>[95.0%]</b> (Hysteresis: 0.05%)	The maximum permissible negative deviation of the generator frequency from the rated system frequency (parameter 1750 ↪ p. 95) is configured here.  This value may be used as a frequency limit switch. The conditional state of this switch may be used as a command variable for the LogicsManager (02.04).

4.4.1.2 Generator Overfrequency (Level 1 & 2) ANSI# 810

General notes

This controller provides the user with two alarm levels for generator overfrequency. Both alarms are definite time alarms.

Monitoring for overfrequency faults is performed in two steps.



If this protective function is triggered, the display indicates "Gen. overfrequency 1" or "Gen. overfrequency 2" and the logical command variable "06.01" or "06.02" will be enabled.

Refer to [Chapter 9.1.1 "Triggering Characteristics"](#) on page 551 for the triggering characteristic of this monitoring function. The diagrams listed there show a frequency trend and the associated pickup times and length of the alarms.



The parameter limits listed below have identical setting ranges. Each parameter may be configured with different settings to create unique trip characteristics for specific thresholds.

ID	Parameter	CL	Setting range [Default]	Description
1900 1906	<b>Monitoring</b>	2	[On]	Overfrequency monitoring is carried out according to the following parameters. Monitoring is performed at two levels. Both values may be configured independent from each other (prerequisite: Level 1 limit < limit 2).
Off			Monitoring is disabled for Level 1 limit and/or Level 2 limit.	
1904 1910	<b>Limit</b>	2	50.0 to 140.0 % 1904: <b>[110.0 %]</b> 1910: <b>[115.0 %]</b>  (Hysteresis: 0.05 Hz)  (Reset Delay: 80 ms)	The percentage values that are to be monitored for each threshold limit are defined here.  If this value is reached or exceeded for at least the delay time without interruption, the action specified by the alarm class is initiated.
			<b>Notes</b> This value refers to the System rated frequency (parameter 1750 <a href="#">p. 95</a> ).	
1905 1911	<b>Delay</b>	2	0.02 to 99.99 s 1905: <b>[1.50 s]</b> 1911: <b>[0.30 s]</b>	If the monitored generator frequency value exceeds the threshold value for the delay time configured here, an alarm will be issued.
			<b>Notes</b> If the monitored generator frequency falls below the threshold (minus the hysteresis) before the delay expires the time will be reset.	
1901 1907	<b>Alarm class</b>	2	Class A/B/C/D/E/F, Control  1901: <b>[B]</b> 1907: <b>[F]</b>	Each limit may be assigned an independent alarm class that specifies what action should be taken when the limit is surpassed.
			<b>Notes</b> For additional information refer to <a href="#">Chapter 9.5.1 "Alarm Classes"</a> on page 733	
1902 1908	<b>Self acknowledge</b>	2	Yes	The control unit automatically clears the alarm if the fault condition is no longer detected.

ID	Parameter	CL	Setting range [Default]	Description
			[No]	The control unit does not automatically reset the alarm when the fault condition is no longer detected.  The alarm must be acknowledged and reset by manually pressing the appropriate buttons or by activating the LogicsManager output "External acknowledgement" (via a discrete input or via an interface).
1903 1909	<b>Delayed by engine speed</b>	2	Yes	Monitoring for fault conditions is not performed until engine delayed monitoring is enabled. The engine monitoring delay time (parameter 3315 ↗ p. 270) must expire prior to fault monitoring being enabled for parameters assigned this delay.
			[No]	Monitoring for this fault condition is continuously enabled regardless of engine speed.

#### 4.4.1.3 Generator Underfrequency (Level 1 & 2) ANSI# 81U

##### General notes

This controller provides the user with two alarm levels for generator underfrequency. Both alarms are definite time alarms.

Monitoring for underfrequency faults is performed in two steps.



*If this protective function is triggered, the display indicates "Gen. underfrequency 1" or "Gen. underfrequency 2" and the logical command variable "06.03" or "06.04" will be enabled.*

Refer to ↗ Chapter 9.1.1 "Triggering Characteristics" on page 551 for the triggering characteristic of this monitoring function. The diagrams listed there show a frequency trend and the associated pickup times and length of the alarms.



*The parameter limits listed below have identical setting ranges. Each parameter may be configured with different settings to create unique trip characteristics for specific thresholds.*



*This monitoring function is disabled when the idle mode ( ↗ Chapter 4.5.9.4 "Idle Mode" on page 274) is active.*

ID	Parameter	CL	Setting range [Default]	Description
1950 1956	<b>Monitoring</b>	2	[On]	Underfrequency monitoring is carried out according to the following parameters. Monitoring is performed at two levels. Both values may be configured independent from each other (prerequisite: Level 1 limit > limit 2).
			Off	Monitoring is disabled for Level 1 limit and/or Level 2 limit.



ID	Parameter	CL	Setting range [Default]	Description
1954 1960	<b>Limit</b>	2	50.0 to 130.0 % 1954: <b>[90.0 %]</b> 1960: <b>[84.0 %]</b>  (Hysteresis: 0.05 Hz)  (Reset Delay: 80 ms)	The percentage values that are to be monitored for each threshold limit are defined here.  If this value is reached or exceeded for at least the delay time without interruption, the action specified by the alarm class is initiated.
<b>Notes</b> This value refers to the System rated frequency (parameter 1750 ↪ p. 95).				
1955 1961	<b>Delay</b>	2	0.02 to 99.99 s 1955: <b>[5.00 s]</b> 1961: <b>[0.30 s]</b>	If the monitored generator frequency value falls below the threshold value for the delay time configured here, an alarm will be issued.
<b>Notes</b> If the monitored generator frequency falls below the threshold (plus the hysteresis) before the delay expires the time will be reset.				
1951 1957	<b>Alarm class</b>	2	Class A/B/C/D/E/F, Control  1951: <b>[B]</b> 1957: <b>[F]</b>	Each limit may be assigned an independent alarm class that specifies what action should be taken when the limit is surpassed.
<b>Notes</b> For additional information refer to ↪ <i>Chapter 9.5.1 "Alarm Classes" on page 733</i>				
1952 1958	<b>Self acknowledge</b>	2	Yes	The control unit automatically clears the alarm if the fault condition is no longer detected.
<b>[No]</b>			The control unit does not automatically reset the alarm when the fault condition is no longer detected.  The alarm must be acknowledged and reset by manually pressing the appropriate buttons or by activating the LogicsManager output "External acknowledgement" (via a discrete input or via an interface).	
1953 1959	<b>Delayed by engine speed</b>	2	<b>[Yes]</b>	Monitoring for fault conditions is not performed until engine delayed monitoring is enabled. The engine monitoring delay time (parameter 3315 ↪ p. 270) must expire prior to fault monitoring being enabled for parameters assigned this delay.
<b>No</b>			Monitoring for this fault condition is continuously enabled regardless of engine speed.	

#### 4.4.1.4 Generator Overvoltage (Level 1 & 2) ANSI# 59

##### General notes

Voltage is monitored according to how the parameter "Generator voltage measuring" (parameter 1851 ↪ p. 96) is configured. This controller provides the user with two alarm levels for generator overvoltage. Both alarms are definite time alarms.

Monitoring for overvoltage faults is performed in two steps.



If this protective function is triggered, the display indicates "Gen. overvoltage 1" or "Gen. overvoltage 2" and the logical command variable "06.05" or "06.06" will be enabled.

Refer to [Chapter 9.1.1 "Triggering Characteristics"](#) on page 551 for the triggering characteristic of this monitoring function. The diagrams listed there show a frequency trend and the associated pickup times and length of the alarms.



The parameter limits listed below have identical setting ranges. Each parameter may be configured with different settings to create unique trip characteristics for specific thresholds.

ID	Parameter	CL	Setting range [Default]	Description
2000 2006	Monitoring	2	[On]	Overvoltage monitoring is carried out according to the following parameters. Monitoring is performed at two levels. Both values may be configured independent from each other (prerequisite: Level 1 limit < limit 2).
			Off	Monitoring is disabled for Level 1 limit and/or Level 2 limit.
2004 2010	Limit	2	50.0 to 150.0 % 2004: [108.0 %] 2010: [112.0 %]  (Hysteresis: 0.7%)  (Reset Delay: 80 ms)	The percentage values that are to be monitored for each threshold limit are defined here.  If this value is reached or exceeded for at least the delay time without interruption, the action specified by the alarm class is initiated.  <b>Notes</b>  This value refers to the System rated frequency (parameter 1766 <a href="#">p. 95</a> ).
2005 2011	Delay	2	0.02 to 99.99 s 2005: [5.00 s] 2011: [0.30 s]	If the monitored generator voltage value exceeds the threshold value for the delay time configured here, an alarm will be issued.  <b>Notes</b>  If the monitored generator voltage falls below the threshold (minus the hysteresis) before the delay expires the time will be reset.
2001 2007	Alarm class	2	Class A/B/C/D/E/F, Control 2001: [B] 2007: [F]	Each limit may be assigned an independent alarm class that specifies what action should be taken when the limit is surpassed.  <b>Notes</b>  For additional information refer to <a href="#">Chapter 9.5.1 "Alarm Classes"</a> on page 733
2002 2008	Self acknowledge	2	Yes	The control unit automatically clears the alarm if the fault condition is no longer detected.
			[No]	The control unit does not automatically reset the alarm when the fault condition is no longer detected.  The alarm must be acknowledged and reset by manually pressing the appropriate buttons or by activating the LogicsManager output "External acknowledgment" (via a discrete input or via an interface).

ID	Parameter	CL	Setting range [Default]	Description
2003 2009	<b>Delayed by engine speed</b>	2	Yes	Monitoring for fault conditions is not performed until engine delayed monitoring is enabled. The engine monitoring delay time (parameter 3315 ↗ p. 270) must expire prior to fault monitoring being enabled for parameters assigned this delay.
[No]			Monitoring for this fault condition is continuously enabled regardless of engine speed.	

#### 4.4.1.5 Generator Undervoltage (Level 1 & 2) ANSI# 27

##### General notes

Voltage is monitored according to how the parameter "Generator voltage measuring" (parameter 1851 ↗ p. 96) is configured. This controller provides the user with two alarm levels for generator undervoltage. Both alarms are definite time alarms.

Monitoring for undervoltage faults is performed in two steps.



*If this protective function is triggered, the display indicates "Gen. undervoltage 1" or "Gen. undervoltage 2" and the logical command variable "06.07" or "06.08" will be enabled.*

Refer to ↗ Chapter 9.1.1 "Triggering Characteristics" on page 551 for the triggering characteristic of this monitoring function. The diagrams listed there show a frequency trend and the associated pickup times and length of the alarms.



*The parameter limits listed below have identical setting ranges. Each parameter may be configured with different settings to create unique trip characteristics for specific thresholds.*



*This monitoring function is disabled when the idle mode ( ↗ Chapter 4.5.9.4 "Idle Mode" on page 274) is active.*

ID	Parameter	CL	Setting range [Default]	Description
2050 2056	<b>Monitoring</b>	2	[On]	Undervoltage monitoring is carried out according to the following parameters. Monitoring is performed at two levels. Both values may be configured independent from each other (prerequisite: Level 1 limit < limit 2).
			Off	Monitoring is disabled for Level 1 limit and/or Level 2 limit.
2054 2060	<b>Limit</b>	2	50.0 to 150.0 % 2054: [92.0 %] 2060: [88.0 %]  (Hysteresis: 0.7%)	The percentage values that are to be monitored for each threshold limit are defined here.  If this value is reached or exceeded for at least the delay time without interruption, the action specified by the alarm class is initiated.

ID	Parameter	CL	Setting range [Default]	Description
			(Reset Delay: 80 ms)	<b>Notes</b> This value refers to the System rated frequency (parameter 1766 ↗ p. 95).
2055 2061	<b>Delay</b>	2	0.02 to 99.99 s 2055: <b>[5.00 s]</b> 2061: <b>[0.30 s]</b>	If the monitored generator voltage value falls below the threshold value for the delay time configured here, an alarm will be issued.  <b>Notes</b> If the monitored generator voltage exceeds the threshold (plus the hysteresis) before the delay expires the time will be reset.
2051 2057	<b>Alarm class</b>	2	Class A/B/C/D/E/F, Control  2051: <b>[B]</b> 2057: <b>[F]</b>	Each limit may be assigned an independent alarm class that specifies what action should be taken when the limit is surpassed.  <b>Notes</b> For additional information refer to ↗ Chapter 9.5.1 "Alarm Classes" on page 733
2052 2058	<b>Self acknowledge</b>	2	Yes  <b>[No]</b>	The control unit automatically clears the alarm if the fault condition is no longer detected.  The control unit does not automatically reset the alarm when the fault condition is no longer detected.  The alarm must be acknowledged and reset by manually pressing the appropriate buttons or by activating the LogicsManager output "External acknowledgment" (via a discrete input or via an interface).
2053 2059	<b>Delayed by engine speed</b>	2	<b>[Yes]</b>  No	Monitoring for fault conditions is not performed until engine delayed monitoring is enabled. The engine monitoring delay time (parameter 3315 ↗ p. 270) must expire prior to fault monitoring being enabled for parameters assigned this delay.  Monitoring for this fault condition is continuously enabled regardless of engine speed.

4.4.1.6 Generator Time-Overcurrent (Level 1, 2 & 3) ANSI# 50/51

General notes

Current is monitored according to how the parameter "Generator current measuring" (parameter 1850 ↗ p. 97) is configured. This controller provides the user with three definite time alarm levels for generator overcurrent faults.

Monitoring of the maximum phase current is performed in three steps. Every step can be provided with a delay time independent of the other steps.



*If this protective function is triggered, the display indicates "Gen. overcurrent 1", "Gen. overcurrent 2", or "Gen. overcurrent 3" and the logical command variable "06.09", "06.10.", or "06.11" will be enabled.*

Refer to ↗ Chapter 9.1.1 "Triggering Characteristics" on page 551 for the triggering characteristic of this monitoring function.

ID	Parameter	CL	Setting range [Default]	Description
2200 2206 2212	<b>Monitoring</b>	2	<b>[On]</b>	Overcurrent monitoring is carried out according to the following parameters. Monitoring is performed at three levels. All three values may be configured independent from each other (prerequisite: Level 1 < Level 2 < Level 3).
Off			Monitoring is disabled for Level 1 limit, Level 2 limit, and/or Level 3 limit.	
2204 2210 2216	<b>Limit</b>	2	50.0 to 300.0 % 2204: <b>[110.0 %]</b> 2210: <b>[150.0 %]</b> 2216: <b>[250.0 %]</b> (Hysteresis: 1%) (Reset Delay: 1 s)	The percentage values that are to be monitored for each threshold limit are defined here.  If this value is reached or exceeded for at least the delay time without interruption, the action specified by the alarm class is initiated.  <b>Notes</b> This value refers to the System rated frequency (parameter 1754 ↗ p. 95).
2205 2211 2217			<b>Delay</b>	2
2201 2207 2213	<b>Alarm class</b>	2		
2202 2208 2214			<b>Self acknowledge</b>	2
[No]	The control unit does not automatically reset the alarm when the fault condition is no longer detected.  The alarm must be acknowledged and reset by manually pressing the appropriate buttons or by activating the LogicsManager output "External acknowledgement" (via a discrete input or via an interface).			
2224 2225 2226	<b>Voltage restraint monitoring</b>	2	Yes	The control provides voltage restrained overcurrent relay according to ANSI 51 V individually for each generator current monitoring function.  For details refer to ↗ Chapter 4.4.1.17 "Generator Voltage Restrained Overcurrent Monitoring - ANSI #51" on page 137.
[No]			Voltage restrained monitoring is disabled.	

#### 4.4.1.7 Generator Reverse/Reduced Power (Level 1 & 2) ANSI# 32R/F

##### General notes

The power produced by the generator is calculated from the voltage and current values measured in accordance with how parameters "Generator voltage measuring" (parameter 1851 ↗ p. 96) and "Generator current measuring" (parameter 1850 ↗ p. 97) are configured.

The generator power limits may be configured for reduced power and/or reverse power depending on the threshold values entered. The note below explains how a reduced or reverse power limit is configured.

If the single-phase or three-phase measured real power is below the configured limit of the reduced load or below the configured value of the reverse power, an alarm will be issued.



*If this protective function is triggered, the display indicates "Gen. rev./red. pwr. 1" or "Gen. rev./red. pwr. 2" and the logical command variable "06.12" or "06.13" will be enabled.*

Refer to [Chapter 9.1.1 "Triggering Characteristics"](#) on page 551 for the triggering characteristic of this monitoring function.



### Definition

- *Reduced power Fault initiated if the monitored real power falls below the configured (positive) limit.*
- *Reverse power Fault initiated if the direction of the monitored real power reverses and the configured (negative) limit is exceeded.*

### Configuration examples

The values for reverse /reduced power monitoring can be configured as follows:

- Level 1 limit = Positive and Level 2 limit = Positive (whereas Level 1 limit > Level 2 limit > 0 %)
- Both limits are configured for reduced power monitoring.

#### Example

- Rated power is 100 kW, Level 1 limit = 5 % > Level 2 limit = 3 %
- Tripping if real power falls below 5 kW (Level 1 limit) or 3 kW (Level 2 limit)

- Level 1 limit = Negative and Level 2 limit = Negative (whereas Level 2 limit < Level 1 limit < 0 %)
- Both limits are configured for reverse power monitoring.

#### Example

- Rated power is 100 kW, Level 1 limit = -3 % > Level 2 limit = -5 %
- Tripping if real power falls below -3 kW (Level 1 limit) or -5 kW (Level 2 limit)

- Level 1 limit = Positive and Level 2 limit = Negative (whereas Level 1 limit > 0 % > Level 2 limit)
- Level 1 is configured for reduced power monitoring and
- Level 2 is configured for reverse power monitoring.

#### Example

- Rated power is 100 kW, Level 1 limit = 3 % > Level 2 limit = -5 %
- Tripping if real power falls below 3 kW (Level 1 limit) or -5 kW (Level 2 limit)

ID	Parameter	CL	Setting range [Default]	Description
2250 2256	<b>Monitoring</b>	2	<b>[On]</b>	Reverse/reduced power monitoring is carried out according to the following parameters.  Both values may be configured independent from each other (prerequisite for <b>A03</b> , <b>A04</b> : GCB must be closed).
Off			Monitoring is disabled for Level 1 limit and/or Level 2 limit.	
2254 2260	<b>Limit</b>	2	-99.9 to 99.9 % 2254: <b>[-3.0 %]</b> 2260: <b>[-5.0 %]</b>  (Hysteresis: 1%)  (Reset Delay: 80 ms)	The percentage values that are to be monitored for each threshold limit are defined here.  If this value is reached or fallen below for at least the delay time without interruption, the action specified by the alarm class is initiated.  <b>Notes</b> This value refers to the Generator rated active power (parameter 1752 ↗ p. 95).
2255 2261			<b>Delay</b>	2
2251 2257	<b>Alarm class</b>	2	Class A/B/C/D/E/F, Control  2251: <b>[B]</b> 2257: <b>[F]</b>	Each limit may be assigned an independent alarm class that specifies what action should be taken when the limit is surpassed.  <b>Notes</b> For additional information refer to ↗ <i>Chapter 9.5.1 "Alarm Classes" on page 733</i>
2252 2258			<b>Self acknowledge</b>	2
2253 2259	<b>Delayed by engine speed</b>	2	Yes  <b>[No]</b>	Monitoring for fault conditions is not performed until engine delayed monitoring is enabled. The engine monitoring delay time (parameter 3315 ↗ p. 270) must expire prior to fault monitoring being enabled for parameters assigned this delay.  Monitoring for this fault condition is continuously enabled regardless of engine speed.

4.4.1.8 Generator Overload IOP (Level 1 & 2) ANSI# 32

General notes



*IOP = Isolated Operation in Parallel*

The power produced by the generator is calculated from the voltage and current values measured in accordance with how parameters "Generator voltage measuring" (parameter 1851 ↗ p. 96) and "Generator current measuring" (parameter 1850 ↗ p. 97) are configured. The controller monitors if the system is in a mains parallel or an isolated operation.

When the controller detects that the system is operating isolated from the mains, the Generator Overload MOP (refer to ↗ *Chapter 4.4.1.9 "Generator Overload MOP (Level 1 & 2) ANSI# 32" on page 121*) monitoring is disabled. If the measured generator real power during an isolated operation is above the configured limit an alarm will be issued.



*If this protective function is triggered, the display indicates "Gen. Overload IOP 1" or "Gen. Overload IOP 2" and the logical command variable "06.14" or "06.15" will be enabled.*

Refer to ↗ *Chapter 9.1.1 "Triggering Characteristics" on page 551* for the triggering characteristic of this monitoring function.

ID	Parameter	CL	Setting range [Default]	Description
2300 2306	<b>Monitoring</b>	2	[On]  Off	Overload monitoring is carried out according to the following parameters. Monitoring is performed at two levels.  Both values may be configured independent from each other (prerequisite: Level 1 limit < Level 2 limit).  Monitoring is disabled for Level 1 limit and/or Level 2 limit.
2304 2310	<b>Limit</b>	2	50.0 to 300.00 % 2304: [110.0 %] 2310: [120.0 %] (Hysteresis: 1%) (Reset Delay: 80 ms)	The percentage values that are to be monitored for each threshold limit are defined here.  If this value is reached or exceeded for at least the delay time without interruption, the action specified by the alarm class is initiated.  <b>Notes</b> This value refers to the Generator rated active power (parameter 1752 ↗ p. 95).
2305 2311	<b>Delay</b>	2	0.02 to 99.99 s 2305: [11.00 s] 2311: [0.10 s]	If the monitored generator load exceeds the threshold value for the delay time configured here, an alarm will be issued.  <b>Notes</b> If the monitored generator load falls below the threshold (minus the hysteresis) before the delay expires the time will be reset.
2301 2307	<b>Alarm class</b>	2	Class A/B/C/D/E/F, Control 2301: [B] 2307: [D]	Each limit may be assigned an independent alarm class that specifies what action should be taken when the limit is surpassed.  <b>Notes</b> For additional information refer to ↗ <i>Chapter 9.5.1 "Alarm Classes" on page 733</i>



ID	Parameter	CL	Setting range [Default]	Description
2302 2308	Self acknowledge	2	Yes	The control automatically clears the alarm if the fault condition is no longer detected.
[No]			The control does not automatically reset the alarm when the fault condition is no longer detected.  The alarm must be acknowledged and reset by manually pressing the appropriate buttons or by activating the LogicsManager output "External acknowledgment" (via a discrete input or via an interface).	

#### 4.4.1.9 Generator Overload MOP (Level 1 & 2) ANSI# 32

##### General notes



*MOP = Mains Parallel Operation*

The power produced by the generator is calculated from the voltage and current values measured in accordance with how parameters "Generator voltage measuring" (parameter 1851 ↗ p. 96) and "Generator current measuring" (parameter 1850 ↗ p. 97) are configured.

The controller monitors if the system is in a mains parallel or an isolated operation. When the controller detects that the system is operating parallel with the mains, the Generator Overload IOP (refer to ↗ Chapter 4.4.1.8 "Generator Overload IOP (Level 1 & 2) ANSI# 32" on page 119) monitoring is disabled. If the measured generator real power during a mains parallel operation is above the configured limit an alarm will be issued.



*If this protective function is triggered, the display indicates "Gen. Overload MOP 1" or "Gen. Overload MOP 2" and the logical command variable "06.23" or "06.24" will be enabled.*

Refer to ↗ Chapter 9.1.1 "Triggering Characteristics" on page 551 for the triggering characteristic of this monitoring function.

ID	Parameter	CL	Setting range [Default]	Description
2350 2356	Monitoring	2	[On]	Overload monitoring is carried out according to the following parameters. Monitoring is performed at two levels.  Both values may be configured independent from each other (prerequisite: Level 1 limit < Level 2 limit).
Off			Monitoring is disabled for Level 1 limit and/or Level 2 limit.	
2354 2360	Limit	2	50.0 to 300.00 %  2354: [110.0 %] 2360: [120.0 %]  (Hysteresis: 1%)	The percentage values that are to be monitored for each threshold limit are defined here.  If this value is reached or exceeded for at least the delay time without interruption, the action specified by the alarm class is initiated.

ID	Parameter	CL	Setting range [Default]	Description
			(Reset Delay: 80 ms)	<p><b>Notes</b></p> <p>This value refers to the Generator rated active power (parameter 1752 ↗ p. 95).</p>
2355 2361	<b>Delay</b>	2	0.02 to 99.99 s 2355: <b>[11.00 s]</b> 2361: <b>[0.10 s]</b>	<p>If the monitored generator load exceeds the threshold value for the delay time configured here, an alarm will be issued.</p> <p><b>Notes</b></p> <p>If the monitored generator load falls below the threshold (minus the hysteresis) before the delay expires the time will be reset.</p>
2351 2357	<b>Alarm class</b>	2	Class A/B/C/D/E/F, Control 2351: <b>[B]</b> 2357: <b>[D]</b>	<p>Each limit may be assigned an independent alarm class that specifies what action should be taken when the limit is surpassed.</p> <p><b>Notes</b></p> <p>For additional information refer to ↗ Chapter 9.5.1 "Alarm Classes" on page 733</p>
2352 2358	<b>Self acknowledge</b>	2	Yes  <b>[No]</b>	<p>The control automatically clears the alarm if the fault condition is no longer detected.</p> <p>The control does not automatically reset the alarm when the fault condition is no longer detected.</p> <p>The alarm must be acknowledged and reset by manually pressing the appropriate buttons or by activating the LogicsManager output "External acknowledgment" (via a discrete input or via an interface).</p>

4.4.1.10 Generator Unbalanced Load (Level 1 & 2) ANSI# 46

General notes

Unbalanced load is monitored according to how the parameters "Generator voltage measuring" (parameter 1851 ↗ p. 96) and "Generator current measuring" (parameter 1850 ↗ p. 97) are configured. The unbalanced load alarm monitors the individual phase currents of the generator. The percentage threshold value is the permissible variation of one phase from the average measured current of all three phases.



*If this protective function is triggered, the display indicates "Unbalanced load 1" or "Unbalanced load 2" and the logical command variable "06.16" or "06.17" will be enabled.*

Refer to ↗ Chapter 9.1.1 "Triggering Characteristics" on page 551 for the triggering characteristic of this monitoring function.



*This monitoring function is only enabled when Generator voltage measuring (parameter 1851 ↗ p. 96) is configured to "3Ph 4W" or "3Ph 3W" and Generator current measuring (parameter 1850 ↗ p. 97) is configured to "L1 L2 L3".*

Formulas

	Phase L1	Phase L2	Phase L3
<b>Exceeding</b>	$I_{L1} \geq (3 * I_N * P_A + I_{L2} + I_{L3}) / 2$	$I_{L2} \geq (3 * I_N * P_A + I_{L1} + I_{L3}) / 2$	$I_{L3} \geq (3 * I_N * P_A + I_{L1} + I_{L2}) / 2$
<b>Falling below</b>	$I_{L1} \leq (I_{L2} + I_{L3} - 3 * I_N * P_A) / 2$	$I_{L2} \leq (I_{L1} + I_{L3} - 3 * I_N * P_A) / 2$	$I_{L3} \leq (I_{L1} + I_{L2} - 3 * I_N * P_A) / 2$

Examples

**Exceeding a limit value**

- Current in phase L1 = current in phase L3
- Current in phase L2 has been exceeded
- $P_A$  = tripping value percentage (example 10 %)
- $I_N$  = rated current (example 300 A)

Tripping value for phase L2:

- $I_{L2} \geq (3 * I_N * P_A + I_{L1} + I_{L3}) / 2$   
 $= (3 * 300 \text{ A} * 10 \% + 300 \text{ A} + 300 \text{ A}) / 2$   
 $= ((3 * 300 \text{ A} * 10) / 100 + 300 \text{ A} + 300 \text{ A}) / 2$   
 $= 345 \text{ A}$

**Falling below a limit value**

- Current in phase L2 = current in phase L3
- Current in phase L1 has been undershot
- $P_A$  = tripping value percentage (example 10 %)
- $I_N$  = rated current (example 300 A)

Tripping value for phase L1:

- $I_{L1} \leq (I_{L2} + I_{L3} - 3 * I_N * P_A) / 2$   
 $= (300 \text{ A} + 300 \text{ A} - 3 * 300 \text{ A} * 10 \%) / 2$   
 $= (300 \text{ A} + 300 \text{ A} - (3 * 300 \text{ A} * 10) / 100) / 2$   
 $= 255 \text{ A}$

ID	Parameter	CL	Setting range [Default]	Description
2400 2406	<b>Monitoring</b>	2	[On]	Unbalanced load monitoring is carried out according to the following parameters. Monitoring is performed at two levels.  Both values may be configured independent from each other (condition: Level 1 < Level 2).
			Off	No monitoring is carried out for either Level 1 limit or Level 2 limit.
2404 2410	<b>Limit</b>	2	0.0 to 100.0 % 2404: <b>[10.0 %]</b> 2410: <b>[15.0 %]</b>  (Hysteresis: 0.5%)  (Reset Delay: 80 ms)	The percentage values that are to be monitored for each threshold limit are defined here.  If this value is reached or exceeded for at least the delay time without interruption, the action specified by the alarm class is initiated.
			<b>Notes</b>	This value refers to the "Generator rated current" (parameter 1754 ↗ p. 95)
2405 2411	<b>Delay</b>	2	0.02 to 99.99 s 2405: <b>[10.00 s]</b> 2411: <b>[1.00 s]</b>	If the monitored current exceeds the threshold value for the delay time configured here, an alarm will be issued.

ID	Parameter	CL	Setting range [Default]	Description
				<b>Notes</b> If the monitored current falls below the threshold (minus the hysteresis) before the delay expires the time will be reset.
2401 2407	<b>Alarm class</b>	2	Class A/B/C/D/E/F, Control  2401: <b>[B]</b> 2407: <b>[E]</b>	Each limit may be assigned an independent alarm class that specifies what action should be taken when the limit is surpassed.  <b>Notes</b> For additional information refer to <a href="#">Chapter 9.5.1 "Alarm Classes" on page 733</a>
2402 2408	<b>Self acknowledge</b>	2	Yes  <b>[No]</b>	The control unit automatically clears the alarm if the fault condition is no longer detected.  The control unit does not automatically reset the alarm when the fault condition is no longer detected.  The alarm must be acknowledged and reset by manually pressing the appropriate buttons or by activating the LogicsManager output "External acknowledgment" (via a discrete input or via an interface).
2403 2409	<b>Delayed by engine speed</b>	2	Yes  <b>[No]</b>	Monitoring for fault conditions is not performed until engine delayed monitoring is enabled. The engine monitoring delay time (parameter 3315 <a href="#">p. 270</a> ) must expire prior to fault monitoring being enabled for parameters assigned this delay.  Monitoring for this fault condition is continuously enabled regardless of engine speed.

#### 4.4.1.11 Generator Voltage Asymmetry

##### General notes

The voltage asymmetry monitors absolute value of all three phase-phase voltage difference:  $dV_1=|V_{12}-V_{23}|$ ,  $dV_2=|V_{23}-V_{31}|$  and  $dV_3=|V_{31}-V_{12}|$ . If one of measured  $dV_1$ ,  $dV_2$  or  $dV_3$  exceeds a configured permissible asymmetrical limit, an alarm is issued.

The percentage of permissible asymmetrical limit refers to the generator rated voltage.



*If this protective function is triggered, the display indicates "Gen. volt. asymmetry" and the logical command variable "06.18" will be enabled.*

Refer to [Chapter 9.1.1 "Triggering Characteristics" on page 551](#) for the triggering characteristic of this monitoring function.



*This monitoring function is only enabled if Generator voltage measuring (parameter 1851 [p. 96](#)) is configured to "3Ph 4W" or "3Ph 3W".*

ID	Parameter	CL	Setting range [Default]	Description
3900	Monitoring	2	[On]	Voltage asymmetry monitoring is carried out according to the following parameters.
			Off	No monitoring is carried out.
3903	Limit	2	0.5 to 15.0 % [10.0 %] (Hysteresis: 0.5%) (Reset Delay: 80 ms)	The percentage values that are to be monitored for each threshold limit are defined here.  If this value is reached or exceeded for at least the delay time without interruption, the action specified by the alarm class is initiated.
			<b>Notes</b>	This value refers to the Generator rated voltage (parameter 1766 ↪ p. 95).
3904	Delay	2	0.02 to 99.99 s [5.00 s]	If the monitored generator voltage asymmetry exceeds the threshold value for the delay time configured here, an alarm will be issued.
			<b>Notes</b>	If the monitored generator voltage asymmetry falls below the threshold (minus the hysteresis) before the delay expires the time will be reset
3901	Alarm class	2	Class A/B/C/D/E/F, Control [F]	Each limit may be assigned an independent alarm class that specifies what action should be taken when the limit is surpassed.
			<b>Notes</b>	For additional information refer to ↪ Chapter 9.5.1 "Alarm Classes" on page 733
3902	Self acknowledge	2	Yes	The control unit automatically clears the alarm if the fault condition is no longer detected.
			[No]	The control unit does not automatically reset the alarm when the fault condition is no longer detected.  The alarm must be acknowledged and reset by manually pressing the appropriate buttons or by activating the LogicsManager output "External acknowledgment" (via a discrete input or via an interface).
3905	Delayed by engine speed	2	[Yes]	Monitoring for fault conditions is not performed until engine delayed monitoring is enabled. The engine monitoring delay time (parameter 3315 ↪ p. 270) must expire prior to fault monitoring being enabled for parameters assigned this delay.
			No	Monitoring for this fault condition is continuously enabled regardless of engine speed.

#### 4.4.1.12 Generator Ground Fault (Level 1 & 2)

##### General notes



The generator ground fault is determined differently depending on the following configuration options:

- Mains current input is configured for mains current (calculated ground fault)
- Mains current input is configured for ground current (measured ground fault)

Refer to parameter 1854 ↪ p. 98.

**Calculated ground fault**

The current produced by the generator is monitored depending on how parameter "Generator current measuring" (parameter 1850 ↪ p. 97) is configured. The measured three conductor currents  $I_{Gen-L1}$ ,  $I_{Gen-L2}$  and  $I_{Gen-L3}$  are vectorially totaled ( $I_S = I_{Gen-L1} + I_{Gen-L2} + I_{Gen-L3}$ ) and compared with the configured fault limit (the calculated actual value is indicated in the display). If the measured value exceeds the fault threshold limit, a ground fault is present, and an alarm is issued.

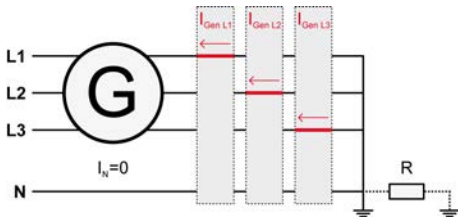

Fig. 69: Generator ground fault - schematic



If this protective function is triggered, the display indicates "Ground fault 1" or "Ground fault 2" and the logical command variable "06.19" or "06.20" will be enabled.



The ground fault protection zone is determined by the location where the generator current transformer are physically installed.

**Test**

- ➔ Short-circuit one of the three generator current transformers while the generator is at full load.
  - ⇒ The measured current should read 100 % of rated on the two phases that do not have their current transformers short-circuited.

The ground current calculation does not take current on the neutral conductor into consideration. In order for the controller to be able to perform calculated ground fault current protection accurately, the neutral conductor must not conduct current.

The fault threshold value is configured as a percentage. This percentage threshold refers to the generator rated current (parameter 1754 ↪ p. 95). Due to unavoidable load asymmetries, the minimum value for this parameter should be 10 % or greater.

**Calculation**

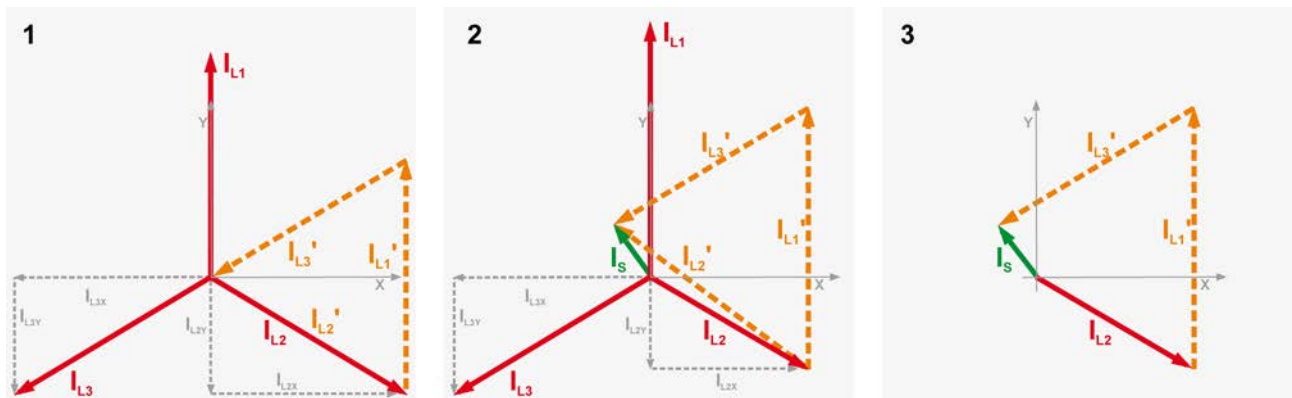

Fig. 70: Generator ground fault - calculation

- 1 No ground fault
- 2 Ground fault (with vectorial calculation)
- 3 Ground fault ( $I_S =$  ground fault current)

The ground current  $I_S$  is calculated geometrically/vectorially. The pointers for phase currents  $I_{L1}$  and  $I_{L2}$  are parallel shifted and lined up as shown in ( Fig. 70/1).

The pointer between the neutral point and the point of the shifted pointer  $I_{L2}'$  results is the sum current  $I_S$  as shown in ( Fig. 70/2).

In order to be able to add the pointers vectorially, these must be divided into their X- and Y-coordinates ( $I_{L2X}$ ,  $I_{L2Y}$ ,  $I_{L3X}$  and  $I_{L3Y}$ ).

The ground fault current may be calculated using the following formula:

- $(I_{L1rated} + I_{L2rated} + I_{L3rated}) - (I_{L1measured} + I_{L2measured} + I_{L3measured}) / 1.73 = I_S$
- $(7 A + 7 A + 7 A) - (7A + 6.5 A + 6 A) / 1.73 = 0.866 A$

Results of a calculation example:

- Phase current  $I_{L1} = I_{Rated} = 7 A$
- Phase current  $I_{L2} = 6.5 A$
- Phase current  $I_{L3} = 6 A$

### Measured ground fault

Ground fault current is actively measured when the mains current input is configured to monitor for ground current. The ground fault threshold is configured as a percentage of the value entered for parameter "Ground current transformer" (parameter 1810 ↪ p. 101).



*The ground fault protection zone is determined by the physical installation location of the generator current transformer.*

ID	Parameter	CL	Setting range [Default]	Description
3250 3256	<b>Monitoring</b>	2	On	Ground current monitoring is carried out according to the following parameters. Monitoring is performed at two levels. Both values may be configured independent from each other (prerequisite: Level 1 < Level 2).
[Off]			Monitoring is disabled for Level 1 limit and/or Level 2 limit.	
3254 3260	<b>Limit</b>	2	0 to 300 % 3254: <b>[10 %]</b> 3260: <b>[30 %]</b>  (Hysteresis: 1%)  (Reset Delay: 80 ms)	The percentage values that are to be monitored for each threshold limit are defined here.  If this value is reached or exceeded for at least the delay time without interruption, the action specified by the alarm class is initiated.  <b>Notes</b> This value refers to the Generator rated current of the generator (parameter 1754 ↪ p. 95), if the ground current is calculated from the generator current values.  It refers to the parameter "Ground current transformer" (parameter 1810 ↪ p. 101), if the ground current is measured directly.  The ground fault threshold shall not exceed the mains/ground current measuring range (approx. $1.5 \times I_{rated}$ ; ↪ Chapter 8.1 "Technical Data" on page 543).
3255 3261			<b>Delay</b>	2

## Configuration

Configure Monitoring > Generator > Generator Ground Fault (Le...

ID	Parameter	CL	Setting range [Default]	Description
3251 3257	<b>Alarm class</b>	2	Class A/B/C/D/E/F, Control	Each limit may be assigned an independent alarm class that specifies what action should be taken when the limit is surpassed.
3251: <b>[B]</b> 3257: <b>[F]</b>			<p><b>Notes</b></p> <p>For additional information refer to ↪ <i>Chapter 9.5.1 "Alarm Classes" on page 733</i></p>	
3252 3258	<b>Self acknowledge</b>	2	Yes	The control unit automatically clears the alarm if the fault condition is no longer detected.
			<b>[No]</b>	<p>The control unit does not automatically reset the alarm when the fault condition is no longer detected.</p> <p>The alarm must be acknowledged and reset by manually pressing the appropriate buttons or by activating the LogicsManager output "External acknowledgment" (via a discrete input or via an interface).</p>
3253 3259	<b>Delayed by engine speed</b>	2	Yes	Monitoring for fault conditions is not performed until engine delayed monitoring is enabled. The engine monitoring delay time (parameter 3315 ↪ p. 270) must expire prior to fault monitoring being enabled for parameters assigned this delay.
			<b>[No]</b>	Monitoring for this fault condition is continuously enabled regardless of engine speed.



#### 4.4.1.13 Generator Phase Rotation

##### General notes

**NOTICE!****Damage to the control unit and/or generation equipment**

- Ensure that the control unit is properly connected to phase voltages on both sides of the circuit breaker(s) during installation.

Failure to do so may result in damage to the control unit and/or generation equipment due to the breaker closing asynchronously or with mismatched phase rotations. Also ensure that phase rotation monitoring is enabled at all connected components (engine, generator, breakers, cable, busbars, etc.).

This function will block a connection of systems with mismatched phases only under the following conditions:

- The voltages being measured are wired correctly with respect to the phase rotation at the measuring points (i.e. the potential transformers in on both sides of the circuit breaker)
- The voltages being measured are wired so that angular phase shifts or any interruptions from the measuring point to the control unit do not exist
- The voltages being measured are wired to the correct terminals of the control unit (i.e. L1 phase of the generator is connected with the terminal of the control unit which is intended for the generator L1 phase)
- The configured alarm class is of class C, D, E, or F (shutdown alarm).

Correct phase rotation of the phase voltages ensures that damage will not occur during a breaker closure to either the mains or the generator. The voltage phase rotation alarm checks the phase rotation of the measured voltages and the configured phase rotation to ensure they are identical.

The directions of rotation are differentiated as "clockwise" and "counter clockwise". With a clockwise field the direction of rotation is "L1-L2-L3"; with a counter clockwise field the direction of rotation is "L1-L3-L2". If the control is configured for a clockwise rotation and the measured voltages are monitored as counterclockwise, the alarm will be initiated.



The direction of configured rotation being monitored by the control unit is displayed on the screen.

If this protective function is triggered, the display indicates "Gen.ph.rot. mismatch" and the logical command variable "06.21" will be enabled.

This monitoring function is only enabled if Generator voltage measuring (parameter 1851 ↗ p. 96) is configured to "3Ph 4W", "3Ph 3W", or "3Ph 4W OD" and the measured voltage exceeds 50 % of the rated voltage (parameter 1766 ↗ p. 95) or if Generator voltage measuring (parameter 1851 ↗ p. 96) is configured to "1Ph 2W" (in this case, the phase rotation is not evaluated, but defined by the 1Ph2W phase rotation (parameter 1859 ↗ p. 96)).

ID	Parameter	CL	Setting range [Default]	Description
3950	Monitoring	2	[On]	Phase rotation monitoring is carried out according to the following parameters.
			Off	No monitoring is carried out.
3954	Generator phase rotation	2	[CW]	The three-phase measured generator voltage is rotating CW (clock-wise; that means the voltage rotates in L1-L2-L3 direction; standard setting).
			CCW	The three-phase measured generator voltage is rotating CCW (counter clock-wise; that means the voltage rotates in L1-L3-L2 direction).
3951	Alarm class	2	Class A/B/C/D/E/F, Control	Each limit may be assigned an independent alarm class that specifies what action should be taken when the limit is surpassed.
			[F]	Notes For additional information refer to ↗ Chapter 9.5.1 "Alarm Classes" on page 733
3952	Self acknowledge	2	Yes	The control unit automatically clears the alarm if the fault condition is no longer detected.
			[No]	The control unit does not automatically reset the alarm when the fault condition is no longer detected.  The alarm must be acknowledged and reset by manually pressing the appropriate buttons or by activating the LogicsManager output "External acknowledgement" (via a discrete input or via an interface).
3953	Delayed by engine speed	2	[Yes]	Monitoring for fault conditions is not performed until engine delayed monitoring is enabled. The engine monitoring delay time (parameter 3315 ↗ p. 270) must expire prior to fault monitoring being enabled for parameters assigned this delay.
			No	Monitoring for this fault condition is continuously enabled regardless of engine speed.

#### 4.4.1.14 Generator Inverse Time-Overcurrent ANSI# IEC 255

##### General notes

The current produced by the generator is monitored depending on how parameter "Generator current measuring" (parameter 1850 ↗ p. 97) is configured. If an overcurrent condition is detected, the fault recognition time is determined by the configured tripping characteristic curve and the measured current.

The tripping time is faster as the measured current increases in magnitude according to a defined curve. According to IEC 255 three different characteristics are available.

If this protective function is triggered, the display indicates "Inv. time overcurr." and the logical command variable "06.22" will be enabled.

- "Normal inverse" characteristic:

$$t = 0.14 / (I/I_P)^{0.02} - 1) * t_P[s]$$

- "Highly inverse" characteristic:

$$t = 13.5 / (I/I_P) - 1) * t_P[s]$$

- "Extremely inverse" characteristic:

$$t = 80 / (I/I_P)^2 - 1) * t_P[s]$$

Variables:

- $t$  = tripping time
- $t_P$  = setting value time
- $I$  = measured fault current
- $I_P$  = setting value current

Please take into account during configuration:

- for  $I_{start}$ :  
 $I_{start} > I_n$  and  $I_{start} > I_P$
- for  $I_P$  the smaller  $I_P$  is, the steeper is the slope of the tripping curve



*The maximum tripping time is 327 s. If a tripping time greater than 327 s is configured, an overcurrent fault condition will not be recognized.*

Characteristics

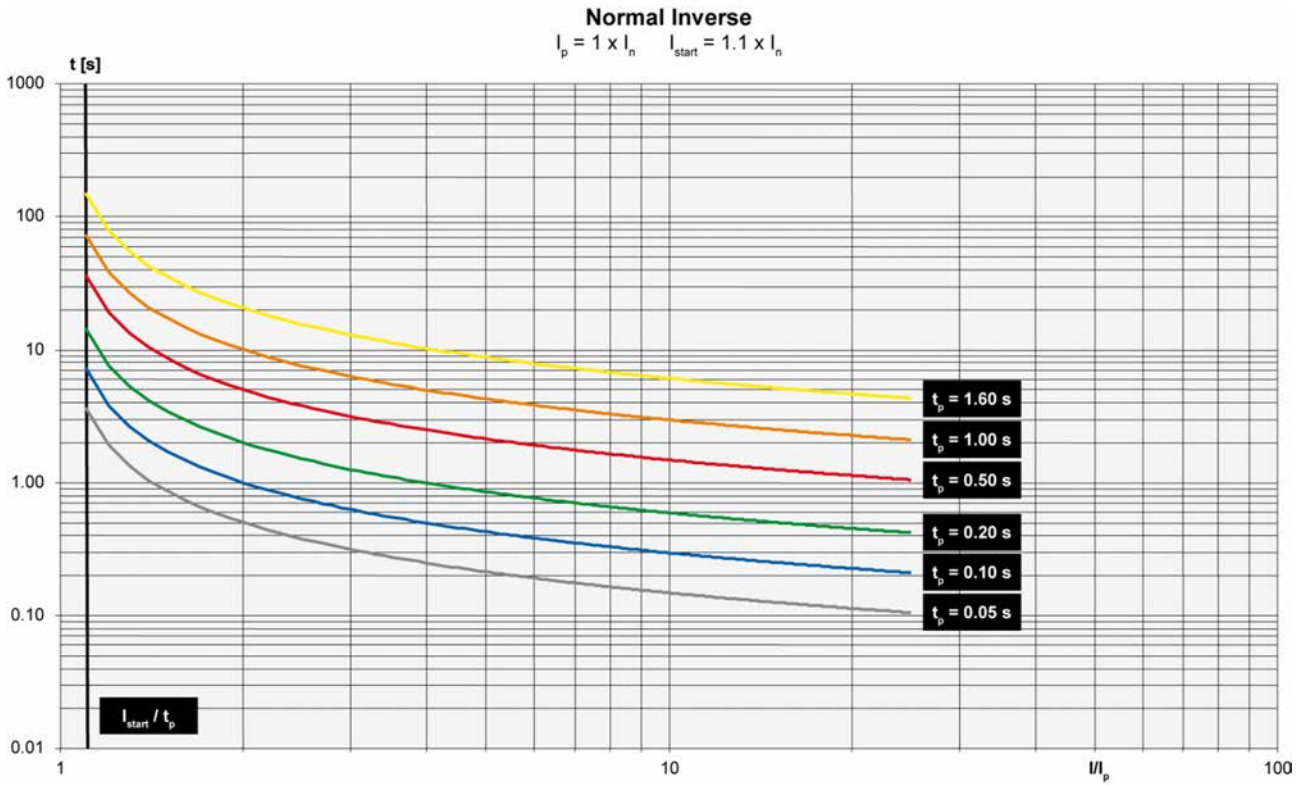

Fig. 71: "Normal inverse" characteristic

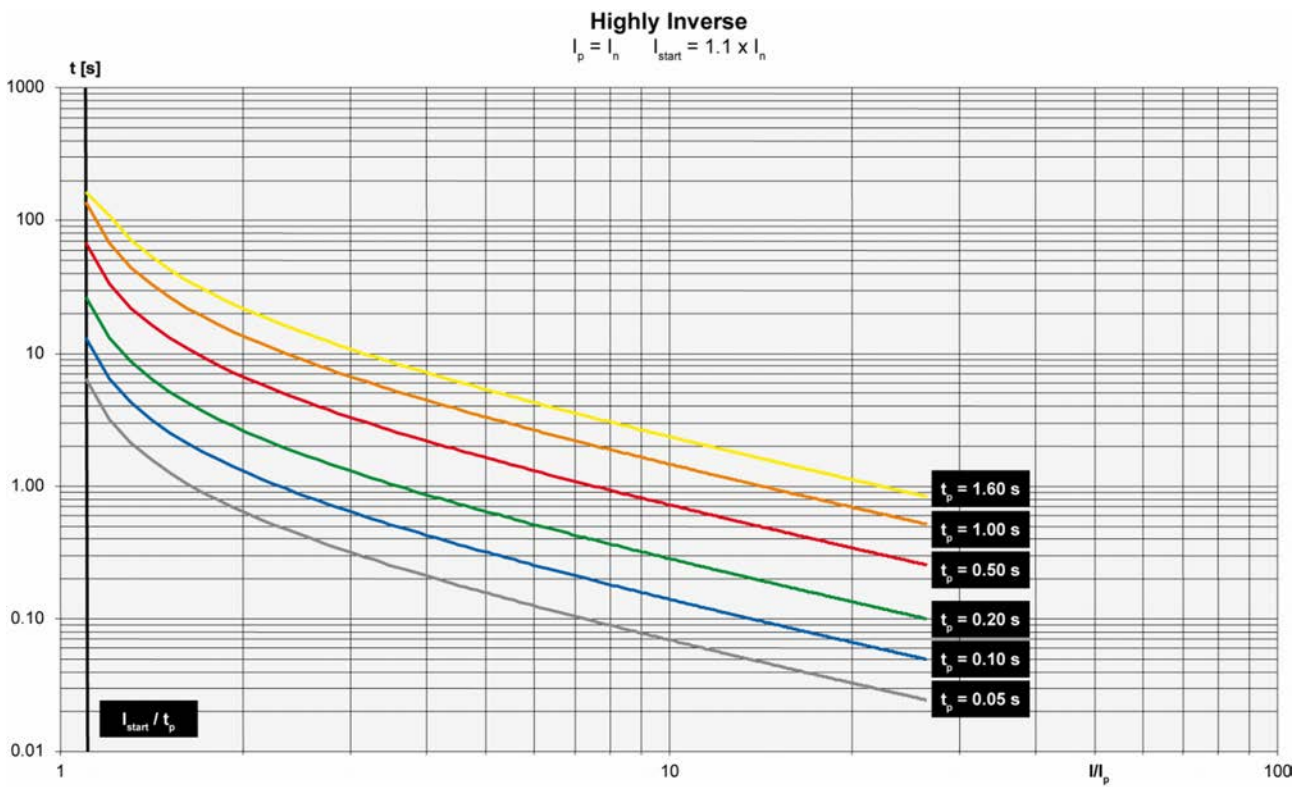

Fig. 72: "Highly inverse" characteristic

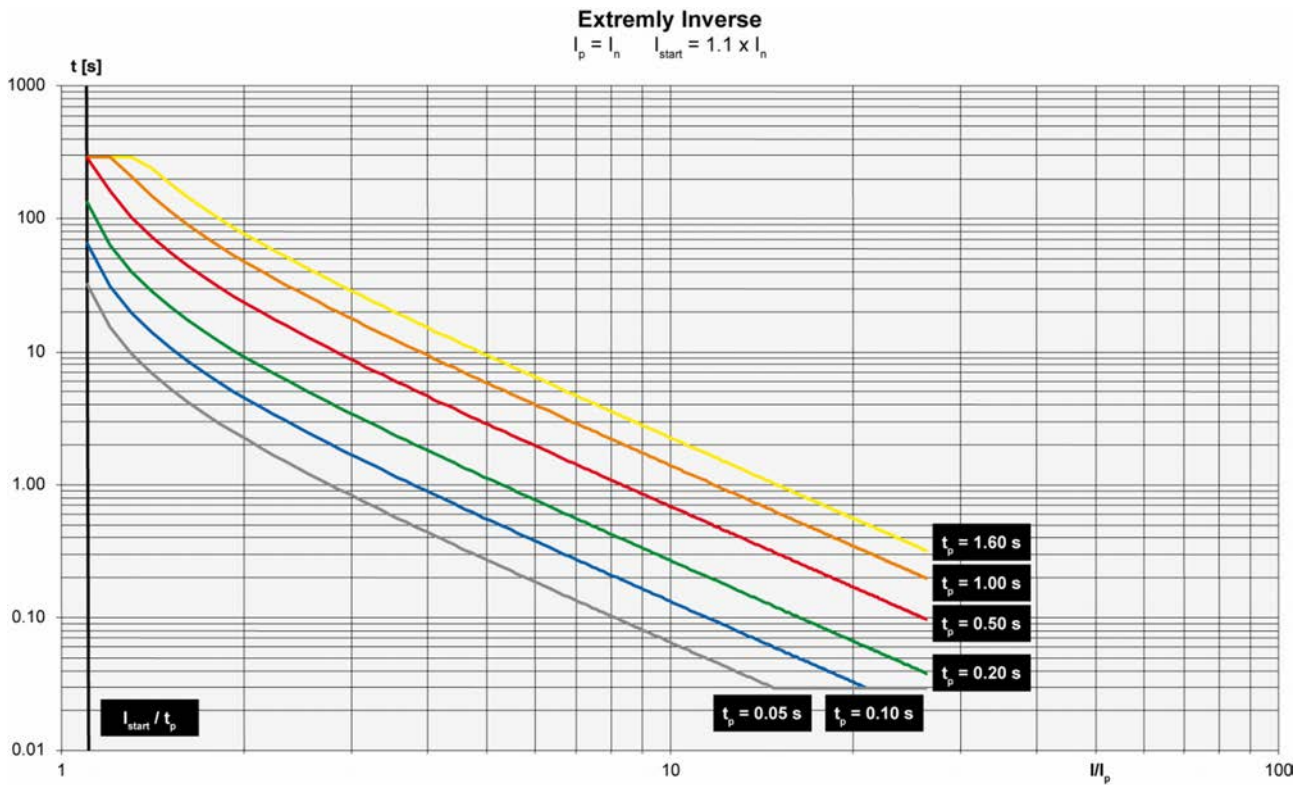

Fig. 73: "Extremely inverse" characteristic

ID	Parameter	CL	Setting range [Default]	Description
4030	<b>Monitoring</b>	2	<b>[On]</b>	Overcurrent monitoring is carried out according to the following parameters.
			Off	No monitoring is carried out.
4034	<b>Inverse time characteristic</b>	2		Selection of the used overcurrent characteristic.
			<b>[Normal]</b>	The "normal inverse" tripping curve will be used
			High	The "highly inverse" tripping curve will be used
			Extreme	The "extremely inverse" tripping curve will be used.
4035	<b>Inverse time overcurrent <math>T_p =</math></b>	2	0.01 to 1.99 s <b>[0.06 s]</b>	Time constant $T_p$ used to calculate the characteristics.
4036	<b>Inverse time overcurr. <math>I_p =</math></b>	2	10.0 to 300.0 % <b>[100.0 %]</b>	Current constant $I_p$ used to calculate the characteristics.
4037	<b>Inv time overcurr. <math>I_{start} =</math></b>	2	100.0 to 300.0 % <b>[115.0 %]</b> (Hysteresis: 1%) (Reset Delay: 1 s)	Lower tripping value for inverse time-overcurrent protection. If the monitored current is less than $I_{start}$ , the inverse time-overcurrent protection does not trip. If $I_{start}$ is less than $I_p$ , $I_p$ is used as the lower tripping value.
4031	<b>Alarm class</b>	2	Class A/B/C/D/E/F, Control <b>[F]</b>	Each limit may be assigned an independent alarm class that specifies what action should be taken when the limit is surpassed.

ID	Parameter	CL	Setting range [Default]	Description
				<b>Notes</b> For additional information refer to ↗ <i>Chapter 9.5.1 "Alarm Classes" on page 733</i>
4032	<b>Self acknowledge</b>	2	Yes	The control unit automatically clears the alarm if the fault condition is no longer detected.
			[No]	The control unit does not automatically reset the alarm when the fault condition is no longer detected.  The alarm must be acknowledged and reset by manually pressing the appropriate buttons or by activating the LogicsManager output "External acknowledgment" (via a discrete input or via an interface).
4033	<b>Delayed by engine speed</b>	2	Yes	Monitoring for fault conditions is not performed until engine delayed monitoring is enabled. The engine monitoring delay time (parameter 3315 ↗ p. 270) must expire prior to fault monitoring being enabled for parameters assigned this delay.
			[No]	Monitoring for this fault condition is continuously enabled regardless of engine speed.
2227	<b>Voltage restraint monitoring</b>	2	Yes	The control provides voltage restrained inverse time overcurrent monitoring.  For general information about voltage restrained monitoring refer to ↗ <i>Chapter 4.4.1.17 "Generator Voltage Restrained Overcurrent Monitoring - ANSI #51" on page 137.</i>
			[No]	Voltage restrained monitoring is disabled.

4.4.1.15 Generator Lagging Power Factor (Level 1 & 2)

General notes

The power factor is monitored for becoming more lagging (i.e. inductive) than an adjustable limit. This limit may be a lagging or leading power factor limit. There are two lagging power factor alarm levels available in the control. This monitoring function may be used for monitoring an overexcitation with a warning and a shut-down alarm level. Both alarms are definite time alarms.

 *The power factor monitoring*

- *is activated,*  
*if the generator current expires 5% rated Generator current and*
- *is blocked,*  
*if the generator current underrun 3% rated Generator current.*

Fig. 74 shows an example of a leading and a lagging power factor limit and the power factor range, for which the lagging power factor monitoring issues an alarm.

 *If this protective function is triggered, the display indicates "Gen. PF lagging 1" or "Gen. PF lagging 2" and the logical command variable "06.25" or "06.26" will be enabled.*

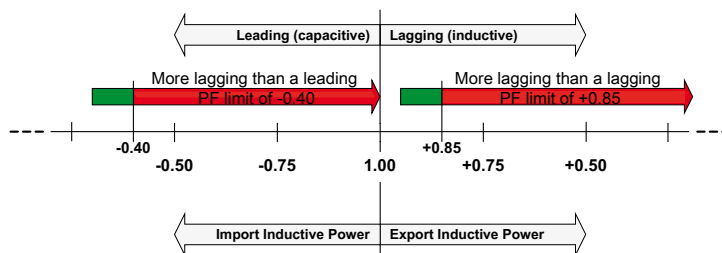

Fig. 74: Generator lagging power factor

ID	Parameter	CL	Setting range [Default]	Description
2325 2331	<b>Monitoring</b>	2	[On]	Generator lagging power factor monitoring is carried out according to the following parameters. Monitoring is performed at two levels. Both values may be configured independent from each other.
			Off	Monitoring is disabled for Level 1 limit and/or Level 2 limit.
2329 2335	<b>Limit</b>	2	-0.999 to 1.000	The values that are to be monitored for each threshold limit are defined here.
			2329: [+ 0.900] 2335: [+ 0.700] (Hysteresis: 0.02%) (Reset Delay: 80 ms)	<b>Notes</b> If the power factor becomes more lagging (i.e. inductive, Fig. 74) than a lagging PF value (positive) or a leading PF value (negative) for at least the delay time (parameters 2330 ↗ p. 135 or 2336 ↗ p. 135) without interruption, the action specified by the alarm class is initiated.
2330 2336	<b>Delay</b>	2	0.02 to 99.99 s	If the monitored generator power factor is more lagging than the configured limit for the delay time configured here, an alarm will be issued.
			2330: [30.00 s] 2336: [1.00 s]	<b>Notes</b> If the monitored generator power factor returns within the limit before the delay expires the time will be reset.
2326 2332	<b>Alarm class</b>	2	Class A/B/C/D/E/F, Control	Each limit may be assigned an independent alarm class that specifies what action should be taken when the limit is surpassed.
			2326: [B] 2332: [B]	<b>Notes</b> For additional information refer to ↗ Chapter 9.5.1 "Alarm Classes" on page 733
2327 2333	<b>Self acknowledge</b>	2	Yes	The control unit automatically clears the alarm if the fault condition is no longer detected.
			[No]	The control unit does not automatically reset the alarm when the fault condition is no longer detected.  The alarm must be acknowledged and reset by manually pressing the appropriate buttons or by activating the LogicsManager output "External acknowledgment" (via a discrete input or via an interface).
2328 2334	<b>Delayed by engine speed</b>	2	[Yes]	Monitoring for fault conditions is not performed until engine delayed monitoring is enabled. The engine monitoring delay time (parameter 3315 ↗ p. 270) must expire prior to fault monitoring being enabled for parameters assigned this delay.
			No	Monitoring for this fault condition is continuously enabled regardless of engine speed.

4.4.1.16 Generator Leading Power Factor (Level 1 & 2)

General notes

The power factor is monitored for becoming more leading (i.e. capacitive) than an adjustable limit. This limit may be a leading or lagging power factor limit. There are two leading power factor alarm levels available in the control. This monitoring function may be used for monitoring an under excitation with a warning and a shutdown alarm level. Both alarms are definite time alarms.

Refer to [Chapter 6.4.1 "Generator Excitation Protection"](#) on page 430 for a detailed description of this monitoring function.

**i** *The power factor monitoring*

- is activated, if the generator current expires 5% rated Generator current and
- is blocked, if the generator current underruns 3% rated Generator current.

Fig. 75 shows an example of a leading and a lagging power factor limit and the power factor range, for which the leading power factor monitoring issues an alarm.

**i** *If this protective function is triggered, the display indicates "Gen. PF leading 1" or "Gen. PF leading 2" and the logical command variable "06.27" or "06.28" will be enabled.*

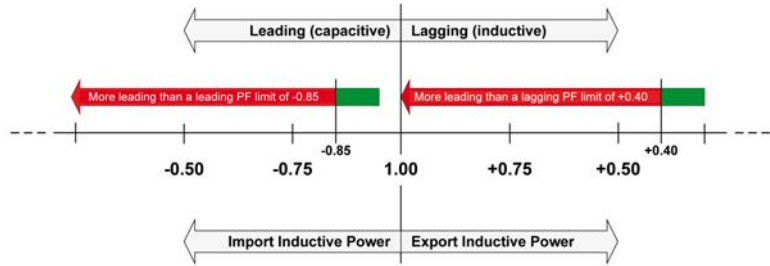

Fig. 75: Generator leading power factor

ID	Parameter	CL	Setting range [Default]	Description
2375 2381	Monitoring	2	[On]	Generator leading power factor monitoring is carried out according to the following parameters. Monitoring is performed at two levels. Both values may be configured independent from each other.
Off			Monitoring is disabled for Level 1 limit and/or Level 2 limit.	
2379 2385	Limit	2	-0.999 to 1.000	The values that are to be monitored for each threshold limit are defined here.
2379: [- 0.900] 2385: [- 0.700] (Hysteresis: 0.02%) (Reset Delay: 80 ms)			<p><b>Notes</b></p> <p>If the power factor becomes more leading (i.e. capacitive, Fig. 75) than a leading PF value (negative) or a lagging PF value (positive) for at least the delay time (parameters 2380 <a href="#">p. 137</a> or 2386 <a href="#">p. 137</a>) without interruption, the action specified by the alarm class is initiated.</p>	



ID	Parameter	CL	Setting range [Default]	Description
2380 2386	Delay	2	0.02 to 99.99 s 2380: <b>[30.00 s]</b> 2386: <b>[1.00 s]</b>	If the monitored generator power factor is more leading than the configured limit for the delay time configured here, an alarm will be issued.  <b>Notes</b> If the monitored generator power factor returns within the limit before the delay expires the time will be reset.
2376 2382			Alarm class	2
2377 2383	Self acknowledge	2		
			[No]	The control unit does not automatically reset the alarm when the fault condition is no longer detected.  The alarm must be acknowledged and reset by manually pressing the appropriate buttons or by activating the LogicsManager output "External acknowledgment" (via a discrete input or via an interface).
2378 2384	Delayed by engine speed	2	[Yes]	Monitoring for fault conditions is not performed until engine delayed monitoring is enabled. The engine monitoring delay time (parameter 3315 <a href="#">p. 270</a> ) must expire prior to fault monitoring being enabled for parameters assigned this delay.
			No	Monitoring for this fault condition is continuously enabled regardless of engine speed.

#### 4.4.1.17 Generator Voltage Restrained Overcurrent Monitoring - ANSI #51

##### General Notes

This function is an add-on to the over current monitoring and decreases the activation limit dependent on the amount of voltage dip. Especially in near to generator located over currents it can lead to situations, where the failure current remains under the generator rated current. In this case a normal over current monitoring does not trip. The voltage restraint over current monitoring considers this and decreases the configured over current limit according to a modification factor, that it comes to a trip.

The considered voltages are either the single phase-phase or phase-neutral voltages. (Refer to "Generator voltage monitoring" 1770 [p. 109](#)). The monitor takes always the lowest considered voltage into account for calculating the modification factor.

In the easYgen the voltage restraint over current monitoring can be activated individually for "Generator over current (limit 1-3)" and Generator inverse time over current, if the according parameter "Voltage restraint monitoring" is switched to "Yes".

The modification factor depends on the measured voltage in percent of rated voltage. It is defined by a characteristic which is defined by three parameters (ID 2230, 2231, 2232 cf. figure). This characteristic is taken into account for all over current monitoring functions, if enabled.

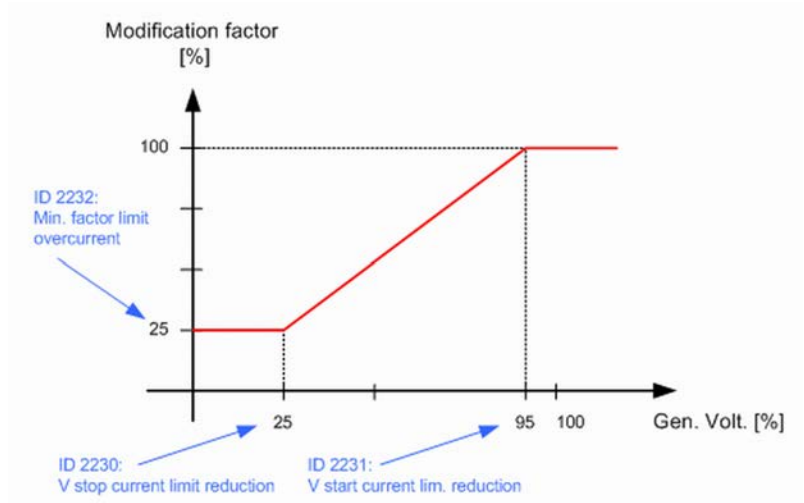

Fig. 76: Example for generator voltage restraint overcurrent characteristic

Beginning at a voltage dip of 95% rated voltage (configured by 2231), the modification factor will be linearly reduced (cf. figure 86). If the voltage reaches 25% or less (configured by 2230) the modification factor will remain at 25% (configured by 2232).

Now the effective limit is calculated as:

$$\text{Effective limit [\%]} = \text{Limit [\%]} * \text{Modification Factor [\%]} / 100[\%]$$

Supposed the configured limit of an over current monitor is 110% and the measured voltage is 25%:

$$\text{Effective limit [\%]} = 110\% * 25\% / 100\% = 27.5\%$$



*The V (voltage) start value configuration must be entered higher as the V stop value configuration. Otherwise the function does not work properly!*

ID	Parameter	CL	Setting range [Default]	Description
2231	V start current lim. reduction	2	5.0 ... 100.0 % [95.0 %]	Voltage for starting current limitation reduction
2230	V stop current lim. reduction	2	5.0 ... 100.0 % [25.0 %]	Voltage for stopping current limitation reduction
2232	Min. factor limit overcurrent	2	5.0 ... 100.0 % [25.0 %]	Minimum factor limit for current limitation reduction

## 4.4.2 Mains

ID	Parameter	CL	Setting range [Default]	Description
1771	<b>Mains voltage monitoring</b>	2		The unit can either monitor the wye voltages (phase-neutral) or the delta voltages (phase-phase). The monitoring of the wye voltage is above all necessary to avoid earth-faults in a compensated or isolated network resulting in the tripping of the voltage protection.
			[Phase - phase]	The phase-phase voltage will be monitored and all subsequent parameters concerning voltage monitoring "mains" are referred to this value (VL-L).
			Phase - neutral	The phase-neutral voltage will be monitored and all subsequent parameters concerning voltage monitoring "mains" are referred to this value (VL-N).
			All	The phase-phase <b>and</b> phase-neutral voltage will be monitored and all subsequent parameters concerning voltage monitoring "mains" are referred to this value (VL-L & VL-N).  This setting is only effective if "Mains voltage measuring" (parameter 1853 ↗ p. 98) is configured to "3Ph 4W".
				<b>Notes</b>  WARNING: This parameter influences the protective functions.  Please be aware that if "Mains voltage monitoring" (parameter 1771 ↗ p. 139) is configured to "All" and the function ↗ Chapter 4.4.2.7 "Mains Voltage Increase" on page 152 is used, that this function only monitors "Phase - neutral".
2801	<b>Mains settling time</b>	2	0 to 9999 s [20 s]	To end the emergency operation, the monitored mains must be within the configured operating parameters without interruption for the minimum period of time set with this parameter without interruption.  This parameter permits delaying the switching of the load from the generator to the mains.  The display indicates "Mains settling" during this time.

### 4.4.2.1 Mains Operating Voltage / Frequency

#### General notes



*The mains operating voltage/frequency parameters are used to trigger mains failure conditions and activate an emergency run.*

*The mains values must be within this ranges to synchronize the mains circuit breaker. It is recommended to configure the operating limits within the monitoring limits.*

#### Example

If the mains rated voltage is 400 V, the upper voltage limit is 110 % (of the mains rated voltage, i.e. 440 V), and the hysteresis for the upper voltage limit is 5 % (of the mains rated voltage, i.e. 20 V), the mains voltage will be considered as being out of the operating limits as soon as it exceeds 440 V and will be considered as being within the operating limits again as soon as it falls below 420 V (440 V – 20 V).

If the rated system frequency is 50 Hz, the lower frequency limit is 90 % (of the rated system frequency, i.e. 45 Hz), and the hysteresis for the lower frequency limit is 5 % (of the rated system frequency, i.e. 2.5 Hz), the mains frequency will be considered as being out of the operating limits as soon as it falls below 45 Hz and will be considered as being within the operating limits again as soon as it exceeds 47.5 Hz (45 Hz + 2.5 Hz).

ID	Parameter	CL	Setting range [Default]	Description
5810	<b>Upper voltage limit</b>	2	100 to 150 % [110 %]	The maximum permissible positive deviation of the mains voltage from the mains rated voltage (parameter 1768 ↗ p. 95) is configured here.  This value may be used as a voltage limit switch. The conditional state of this switch may be used as a command variable for the LogicsManager (02.09).
5814	<b>Hysteresis upper voltage limit</b>	2	0 to 50 % [2 %]	If the mains voltage has exceeded the limit configured in parameter 5810 ↗ p. 140, the voltage must fall below the limit and the value configured here, to be considered as being within the operating limits again.
5811	<b>Lower voltage limit</b>	2	50 to 100 % [90 %]	The maximum permissible negative deviation of the mains voltage from the mains rated voltage (parameter 1768 ↗ p. 95) is configured here.  This value may be used as a voltage limit switch. The conditional state of this switch may be used as a command variable for the LogicsManager (02.09).
5815	<b>Hysteresis lower voltage limit</b>	2	0 to 50 % [2 %]	If the mains voltage has fallen below the limit configured in parameter 5811 ↗ p. 140, the voltage must exceed the limit and the value configured here, to be considered as being within the operating limits again.
5812	<b>Upper frequency limit</b>	2	100.0 to 150.0 % [110.0 %]	The maximum permissible positive deviation of the mains frequency from the rated system frequency (parameter 1750 ↗ p. 95) is configured here.  This value may be used as a frequency limit switch. The conditional state of this switch may be used as a command variable for the LogicsManager (02.10).
5816	<b>Hysteresis upper frequency limit</b>	2	0 to 50.0 % [0.5 %]	If the mains frequency has exceeded the limit configured in parameter 5812 ↗ p. 140, the frequency must fall below the limit and the value configured here, to be considered as being within the operating limits again.
5813	<b>Lower frequency limit</b>	2	50.0 to 100.0 % [90.0 %]	The maximum permissible negative deviation of the mains frequency from the rated system frequency (parameter 1750 ↗ p. 95) is configured here. This value may be used as a frequency limit switch. The conditional state of this switch may be used as a command variable for the LogicsManager (02.10).
5817	<b>Hysteresis lower frequency limit</b>	2	0 to 50.0 % [0.5 %]	If the mains frequency has exceeded the limit configured in parameter 5813 ↗ p. 140, the frequency must raise above the limit and the value configured here, to be considered as being within the operating limits again.

### 4.4.2.2 Mains Decoupling

#### General notes

The mains decoupling function is intended for use in a mains parallel operation and monitors a series of subordinate mains protection thresholds. If a threshold is exceeded, the easYgen initiates a breaker opening and separates the generator(s) from the mains at the defined breaker.

The following thresholds are monitored:

- Overfrequency level 2 ( [↪ Chapter 4.4.2.3 “Mains Overfrequency \(Level 1 & 2\) ANSI# 81O” on page 147](#))
- Underfrequency level 2 ( [↪ Chapter 4.4.2.4 “Mains Underfrequency \(Level 1 & 2\) ANSI# 81U” on page 148](#))
- Overvoltage level 2 ( [↪ Chapter 4.4.2.5 “Mains Overvoltage \(Level 1 & 2\) ANSI# 59” on page 149](#))
- Undervoltage level 2 ( [↪ Chapter 4.4.2.6 “Mains Undervoltage \(Level 1 & 2\) ANSI# 27” on page 151](#))
- Mains phase shift / df/dt (ROCOF) ( [↪ Chapter 4.4.2.10 “Change Of Frequency” on page 159](#))

If one of these protective functions is triggered, the display indicates "Mains decoupling" (the logical command variable "07.25" will be enabled) and the active level 2 alarm.



*The mains decoupling function is optimized on the both relay outputs "GCB open" and "MCB open". In case of using a free relay output in conjunction with the command variable 07.25 an additional delay time of up to 20 ms is to consider.*

### Managing Breaker Open alarm

When the mains decoupling function detects a breaker open failure, the according breaker alarm will be triggered as long the monitoring function is activated. Additionally in cases where the decoupling mode has to change over to the other breaker, (GCB→MCB, MCB→GCB), the alarm text “Decoupling GCB ↔MCB” is indicated. The breaker open alarm already occurs after the mains decoupling feedback delay (refer to ID 3113 [↪ p. 142](#)).

ID	Parameter	CL	Setting range [Default]	Description
12922	<b>Ext. mns. decoupl.</b>  (External mains decoupling)	2	Determined by LogicsManager	The unit may be configured to decouple from the mains when commanded by an external device.
			[[0 & 1] & 1]	Once the conditions of the LogicsManager have been fulfilled, an external mains failure is issued.
			<b>Notes</b>	For information on the LogicsManager and its default settings see <a href="#">↪ Chapter 9.4.1 “LogicsManager Overview” on page 689</a> .
3110	<b>Mains decoupling</b>	2	Off	Mains decoupling monitoring is disabled.
			[GCB]	Mains decoupling is carried out according to the following parameters. If one of the subordinate monitoring functions is triggered, the GCB will be opened. If the unit is operated in parallel with the mains and the MCB opens, the GCB will be closed again.
			GCB->MCB	Mains decoupling is carried out according to the following parameters. If one of the subordinate monitoring functions is triggered, the GCB will be opened. If the reply "GCB open" is not present within the delay configured in parameter 3113 <a href="#">↪ p. 142</a> , the MCB will be opened as well.
			MCB	Mains decoupling is carried out according to the following parameters. If one of the subordinate monitoring functions is triggered, the MCB will be opened.

## Configuration

Configure Monitoring > Mains > Mains Decoupling

ID	Parameter	CL	Setting range [Default]	Description
			MCB->GCB	Mains decoupling is carried out according to the following parameters. If one of the subordinate monitoring functions is triggered, the MCB will be opened. If the reply "MCB open" is not present within the delay configured in parameter 3113 ↗ p. 142, the GCB will be opened as well.
			GCB/MCB by LM	Mains decoupling is carried out. If one of the subordinate monitoring functions is triggered, a breaker will be opened, which is determined by the Logics-Manager equation "15160 ↗ p. 142 LM mains decoupling MCB". If its status is TRUE, the MCB will be opened. If its status is FALSE, the GCB will be opened.
15160	<b>Mains decoupling MCB</b>	2	Determined by LogicsManager [[0 & 1] & 1]	<b>FALSE:</b> If the decoupling is triggered, the GCB will be opened. <b>TRUE:</b> If the decoupling is triggered, the MCB will be opened.
3113	<b>Mains decoupling feedback delay</b>	2	0.2 to 99.90 s [0.40 s]	If the open signal from the respective circuit breaker cannot be detected within the time configured here, the mains decoupling function performs the action as configured in parameter 3110 ↗ p. 141.
3111	<b>Alarm class</b>	2	Class A/B/C/D/E/F, Control [B]	Each limit may be assigned an independent alarm class that specifies what action should be taken when the limit is surpassed.
				<b>Notes</b> For additional information refer to ↗ Chapter 9.5.1 "Alarm Classes" on page 733.
3112	<b>Self acknowledge</b>	2	Yes [No]	The control automatically clears the alarm if the fault condition is no longer detected. The control does not automatically reset the alarm when the fault condition is no longer detected. The alarm must be acknowledged and reset by manually pressing the appropriate buttons or by activating the LogicsManager output "External acknowledgement" (via a discrete input or via an interface).
1733	<b>Test</b>	2	Yes [No]	Activates a test mode which allows a comfortable mains decoupling test. Deactivates the test mode. Mains decoupling is working normal.
				<b>Notes</b> When the test mode is activated a mains decoupling according to the parameterization is triggered, once a mains failure is detected. Thereby the states of things of the breaker reply are irrelevant. A retriggering of the mains decoupling can be performed after 0.5 s + "Mns. decoupling feedback delay" (parameter 3113 ↗ p. 142) without leaving the test mode. As long as the codelevel is ≥ 2 it is possible to switch-off the test mode manually. The test mode switches off automatically after one hour since having turned on or after switching on the operation magnet (engine should start).

#### 4.4.2.2.1 Setup Grid Code AR-N-4105

##### General notes

The German Grid Code VDE-AR-N 4105 instructs the handling of electrical energy sources running parallel to the low voltage grid. This rule has an impact with some items on the genset control. A more detailed description relating to that VDE rule is done through the separated application note “easYgen-3000\_VDE-AR-N 4105” on the manual CD of this product.

Here are some functions which have to be covered according to the 4105 rule:

- The mains decoupling is executed through following monitors:
  - Mains under voltage V<
  - Mains over voltage V>
  - Mains under frequency f<
  - Mains over frequency f>
- Recognizing isolation operation (other decoupling argument)
  - Phase shift OR
  - df/dt
- Button for Testing the Decoupling Facility
- Single-failure-security including self-monitoring

The VDE-AR-N 4105 demands a Single-failure-proof of the mains decoupling function. That means that the decoupling of the generator from the mains must be always ensured, even if a single element in the system fails. So the system must contain two circuit breakers with two independent monitoring functions acting individually on each breaker. That rule pursues the mains protection but not the availability of the electrical source, so in case of doubt the generator should be decoupled from mains.

Woodward solves this requirement with the use of a minimum of two units acting as a system. The system allows incorporating more units, so that the availability of the generator can still be increased.

The demanded two breakers in series are realized through the use of a GCB and a MCB. If only a GCB is available, the customer must install another circuit breaker in addition.

An important item of the VDE-AR-N 4105 is the Single-Failure-Diagnostic, at which a minimum of two units exchange their measurement data and settings over communication interface (usually CANbus). This allows determining, if the Single-Failure-Proof is lost and the unit can issue an alarm.

##### Enable 4105 monitoring

Monitoring according VDE AR-N 4105 per default is [Off]. It can be enabled via Toolkit “Configure Monitoring → Mains → Decoupling” or via Menu (see screen Fig. 77).

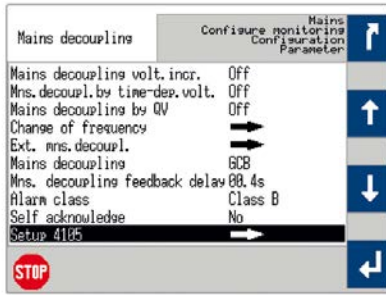

Fig. 77: Select mains decoupling 4105

**Monitoring according AR-N-4105**

ID	Parameter	CL	Setting range [Default]	Description
3297	<b>Monitoring</b>	2	[Off]	The diagnostic function is disabled, no related monitoring is executed.
			Off, CAN 1	If the diagnostic function is enabled, the related CAN messages can be received via CAN 1.
3298	<b>Monitoring mode</b>	2	Single	The diagnostic function is related to one partner unit.
			[Multi]	The diagnostic function is executed with according partner units.
3299	<b>Device number partner</b>	2	[01] 01 to 64	The device ID of the expected partner unit. This configuration is only valid, if the mode 'single' is enabled.
1828	<b>Voltage difference</b>	2	[4.0 %] 2.0 to 9.9 %	This is the voltage measurement tolerance for all participating 4105 partners relating to the mains rated voltage measurement (refer to ID1768 ↗ p. 95). This is a part within the 4105 diagnostic.
1836	<b>Frequency difference</b>	2	[1.0 %] 0.5 to 9.9 %	This is the frequency measurement tolerance for all participating 4105 partners relating to the system rated frequency measurement. (refer to ID1750 ↗ p. 95). This is a part within the 4105 diagnostic.

**Monitoring Missing Member AR-N-4105**

ID	Parameter	CL	Setting range [Default]	Description
5125	<b>Alarm class</b>	2	[C] A to F, control	The alarm class specifies what action should be taken in case of missing communication with device(s) being member(s) of the AR-N-4105 system.
			<p><b>Notes</b></p> <p>For additional information refer to ↗ Chapter 9.5.1 "Alarm Classes" on page 733.</p>	
5126	<b>Self acknowledge</b>	2	No Yes, No	The control unit does not automatically reset the alarm when the fault condition is no longer detected.  The alarm must be acknowledged and reset by manually pressing the appropriate buttons or by activating the LogicsManager output "External acknowledgement" (via a discrete input or via an interface).



**Monitoring Parameter Alignment  
VDE AR-N-4105**

The following parameters are compared for monitoring its alignment:

Control	Parameter ID	Parameter
Mains Decoupling	3110	Mains Decoupling
Overfrequency level 2	2856	Monitoring
	2860	Limit
	2861	Delay
Underfrequency level 2	2906	Monitoring
	2910	Limit
	2911	Delay
Overvoltage level 2	2956	Monitoring
	2960	Limit
	2961	Delay
Undervoltage level 2	3006	Monitoring
	3010	Limit
	3011	Delay
Mains voltage increase	8806	Monitoring
	8808	Mains decoupling volt.incr.
	8807	Limit
Change of frequency	3058	Change of frequency
	3054	Phase shift: Limit 1-phase
	3055	Phase shift: Limit 3-phase
	3104	Limit (df/dt)
	3105	Delay (df/dt)

*Table 31: VDE 4105 alignment: Supervized parameters*

ID	Parameter	CL	Setting range [Default]	Description
5131	Alarm class	2	[C] A to F, control	<p>The alarm class specifies what action should be taken if the parameter alignment between the communication devices(s) of the AR-N-4105 system is active.</p> <p><b>Notes</b></p> <p>For additional information refer to ↗ <i>Chapter 9.5.1 "Alarm Classes" on page 733.</i></p>
5132	Self acknowledge	2	No Yes, No	<p>The control unit does not automatically reset the alarm when the fault condition is no longer detected.</p> <p>The alarm must be acknowledged and reset by manually pressing the appropriate buttons or by activating the LogicsManager output "External acknowledgement" (via a discrete input or via an interface).</p>

Table 32: VDE 4105 alignment: Monitoring

### Monitoring Measurement Difference AR-N-4105

ID	Parameter	CL	Setting range [Default]	Description
5137	Alarm class	2	[C] A to F, control	<p>The alarm class specifies what action should be taken if the measurement difference (frequency, 1836 ↗ p. 144 or voltage, 1828 ↗ p. 144) between the communication devices(s) of the AR-N-4105 system differ more than allowed.</p> <p><b>Notes</b></p> <p>For additional information refer to ↗ <i>Chapter 9.5.1 "Alarm Classes" on page 733.</i></p>
5138	Self acknowledge	2	No Yes, No	<p>The control unit does not automatically reset the alarm when the fault condition is no longer detected.</p> <p>The alarm must be acknowledged and reset by manually pressing the appropriate buttons or by activating the LogicsManager output "External acknowledgement" (via a discrete input or via an interface).</p>

#### 4.4.2.2.2 Setup Grid Code BDEW (medium voltage guideline)

The BDEW Grid Code instructs the handling of electrical energy sources running parallel to the medium voltage grid. This rule has an impact with some items on the genset control. A more detailed description relating to that BDEW technical guideline can be ordered directly by the BDEW Germany. With easYgen functions which have to be covered according to this BDEW rule are supported.

The mains decoupling is executed through following monitors:

- Mains under voltage V<
- Mains under voltage V<<
- Mains over voltage V>
- Mains over voltage V>>
- Mains under frequency f<
- Mains over frequency f>

- Q(V) Monitoring
- Mains Time-Dependent Voltage (FRT)

The Change of frequency monitors (vector/phase shift or df/dt) is not directly required by BDEW. These monitors are depending on the according network providers.

Other functions related to the BDEW guideline:

- Frequency Depending Derating Of Power. Refer to [Chapter 4.5.12.4 "Frequency Depending Derating Of Power"](#) on page 321 for details.
- Reactive Power Control, alternatively:
  - Power Factor Control. Refer to [Chapter 4.5.12.6 "Power Factor Control"](#) on page 327 for details.
  - Power Factor Characteristic. Refer to [Chapter 4.5.12.6.3 "Power Factor Characteristic"](#) on page 333 for details.

### 4.4.2.3 Mains Overfrequency (Level 1 & 2) ANSI# 810

#### General notes

There are two overfrequency alarm levels available in the control. Both alarms are definite time alarms and are illustrated in the figure below. The figure diagrams a frequency trend and the associated pickup times and length of the alarms. Monitoring of the frequency is accomplished in two steps.



*If this protective function is triggered, the display indicates "Mains overfreq. 1" or "Mains overfreq. 2" and the logical command variable "07.06" or "07.07" will be enabled.*

Refer to [Chapter 9.1.1 "Triggering Characteristics"](#) on page 551 for the triggering characteristic of this monitoring function.



*The mains overfrequency Level 2 limit configuration parameters are located below the mains decoupling function menu on the display.*

ID	Parameter	CL	Setting range [Default]	Description
2850 2856	<b>Monitoring</b>	2	[On]	Overfrequency monitoring is carried out according to the following parameters. Monitoring is performed at two levels. Both values may be configured independent from each other (prerequisite: limit 1 < Level 2 limit).
Off			Monitoring is disabled for Level 1 limit and/or Level 2 limit.	
2854 2860	<b>Limit</b>	2	100.0 to 140.0 % 2854: <b>[100.4 %]</b> 2860: <b>[102.0 %]</b>  (Hysteresis: 0.05 Hz)  (Reset Delay: 80 ms)	The percentage values that are to be monitored for each threshold limit are defined here.  If this value is reached or exceeded for at least the delay time without interruption, the action specified by the alarm class is initiated.

ID	Parameter	CL	Setting range [Default]	Description
				<b>Notes</b> This value refers to the System rated frequency (parameter 1750 ↗ p. 95).
2855 2861	<b>Delay</b>	2	0.02 to 99.99 s [0.06 s]	If the monitored mains frequency value exceeds the threshold value for the delay time configured here, an alarm will be issued.  <b>Notes</b> If the monitored mains frequency falls below the threshold (minus the hysteresis) before the delay expires the time will be reset.
2851 2857	<b>Alarm class</b>	2	Class A/B/C/D/E/F, Control 2851: [A] 2857: [B]	Each limit may be assigned an independent alarm class that specifies what action should be taken when the limit is surpassed.  <b>Notes</b> For additional information refer to ↗ Chapter 9.5.1 "Alarm Classes" on page 733
2852 2858	<b>Self acknowledge</b>	2	[Yes]  No	The control unit automatically clears the alarm if the fault condition is no longer detected.  The control unit does not automatically reset the alarm when the fault condition is no longer detected.  The alarm must be acknowledged and reset by manually pressing the appropriate buttons or by activating the LogicsManager output "External acknowledgment" (via a discrete input or via an interface).
2853 2859	<b>Delayed by engine speed</b>	2	Yes  [No]	Monitoring for fault conditions is not performed until engine delayed monitoring is enabled. The engine monitoring delay time (parameter 3315 ↗ p. 270) must expire prior to fault monitoring being enabled for parameters assigned this delay.  Monitoring for this fault condition is continuously enabled regardless of engine speed.

#### 4.4.2.4 Mains Underfrequency (Level 1 & 2) ANSI# 81U

##### General notes

There are two underfrequency alarm levels available in the control. Both alarms are definite time alarms and are illustrated in the figure below. The figure diagrams a frequency trend and the associated pickup times and length of the alarms. Monitoring of the frequency is performed in two steps.



*If this protective function is triggered, the display indicates "Mains underfreq. 1" or "Mains underfreq. 2" and the logical command variable "07.08" or "07.09" will be enabled.*

Refer to ↗ Chapter 9.1.1 "Triggering Characteristics" on page 551 for the triggering characteristic of this monitoring function.



*The mains underfrequency Level 2 limit configuration parameters are located below the mains decoupling function menu on the display.*

ID	Parameter	CL	Setting range [Default]	Description
2900 2906	<b>Monitoring</b>	2	<b>[On]</b>	Underfrequency monitoring is carried out according to the following parameters. Monitoring is performed at two levels.  Both values may be configured independent from each other (prerequisite: Level 1 > Level 2).
Off			Monitoring is disabled for limit 1 and/or Level 2 limit.	
2904 2910	<b>Limit</b>	2	50.0 to 140.0 % 2904: <b>[99.6 %]</b> 2910: <b>[98.0 %]</b>  (Hysteresis: 0.05 Hz)  (Reset Delay: 80 ms)	The percentage values that are to be monitored for each threshold limit are defined here.  If this value is reached or fallen below for at least the delay time without interruption, the action specified by the alarm class is initiated.
<b>Notes</b>			This value refers to the System rated frequency (parameter 1750 ↗ p. 95).	
2905 2911	<b>Delay</b>	2	0.02 to 99.99 s 2905: <b>[1.50 s]</b> 2911: <b>[0.06 s]</b>	If the monitored mains frequency value falls below the threshold value for the delay time configured here, an alarm will be issued.
<b>Notes</b>			If the monitored mains frequency exceeds the threshold (plus the hysteresis) again before the delay expires the time will be reset.	
2901 2907	<b>Alarm class</b>	2	Class A/B/C/D/E/F, Control  2901: <b>[A]</b> 2907: <b>[B]</b>	Each limit may be assigned an independent alarm class that specifies what action should be taken when the limit is surpassed.
<b>Notes</b>			For additional information refer to ↗ <i>Chapter 9.5.1 "Alarm Classes" on page 733</i>	
2902 2908	<b>Self acknowledge</b>	2	<b>[Yes]</b>	The control unit automatically clears the alarm if the fault condition is no longer detected.
No			The control unit does not automatically reset the alarm when the fault condition is no longer detected.  The alarm must be acknowledged and reset by manually pressing the appropriate buttons or by activating the LogicsManager output "External acknowledgment" (via a discrete input or via an interface).	
2903 2909	<b>Delayed by engine speed</b>	2	Yes	Monitoring for fault conditions is not performed until engine delayed monitoring is enabled. The engine monitoring delay time (parameter 3315 ↗ p. 270) must expire prior to fault monitoring being enabled for parameters assigned this delay.
<b>[No]</b>			Monitoring for this fault condition is continuously enabled regardless of engine speed.	

#### 4.4.2.5 Mains Overvoltage (Level 1 & 2) ANSI# 59

##### General notes

Voltage is monitored depending on parameter "Mains voltage measuring" (parameter 1853 ↗ p. 98). There are two overvoltage alarm levels available in the control. Both alarms are definite time alarms and are illustrated in the figure below. The figure diagrams a frequency trend and the associated pickup times and length of the alarms. Monitoring of the voltage is done in two steps.



If this protective function is triggered, the display indicates "Mains overvoltage 1" or "Mains overvoltage 2" and the logical command variable "07.10" or "07.11" will be enabled.

Refer to [Chapter 9.1.1 "Triggering Characteristics"](#) on page 551 for the triggering characteristic of this monitoring function.



The mains overvoltage Level 2 limit configuration parameters are located below the mains decoupling function menu on the display.

ID	Parameter	CL	Setting range [Default]	Description
2950 2956	<b>Monitoring</b>	2	[On]	Overvoltage monitoring is carried out according to the following parameters. Monitoring is performed at two levels. Both values may be configured independent from each other (prerequisite: limit 1 < Level 2 limit).
Off			Monitoring is disabled for Level 1 limit and/or Level 2 limit.	
2954 2960	<b>Limit</b>	2	50.0 to 150.0 % 2954: <b>[108.0 %]</b> 2960: <b>[110.0 %]</b>  (Hysteresis: 0.7%)  (Reset Delay: 80 ms)	The percentage values that are to be monitored for each threshold limit are defined here.  If this value is reached or exceeded for at least the delay time without interruption, the action specified by the alarm class is initiated.  <b>Notes</b> This value refers to the Mains rated voltage (parameter 1768 <a href="#">p. 95</a> ).
2955 2961			<b>Delay</b>	2
2951 2957	<b>Alarm class</b>	2	Class A/B/C/D/E/F, Control  2951: <b>[A]</b> 2957: <b>[B]</b>	Each limit may be assigned an independent alarm class that specifies what action should be taken when the limit is surpassed.  <b>Notes</b> For additional information refer to <a href="#">Chapter 9.5.1 "Alarm Classes"</a> on page 733
2952 2958			<b>Self acknowledge</b>	2
2953 2959	<b>Delayed by engine speed</b>	2	Yes	Monitoring for fault conditions is not performed until engine delayed monitoring is enabled. The engine monitoring delay time (parameter 3315 <a href="#">p. 270</a> ) must expire prior to fault monitoring being enabled for parameters assigned this delay.

ID	Parameter	CL	Setting range [Default]	Description
			[No]	Monitoring for this fault condition is continuously enabled regardless of engine speed.
8845	Mns. decoupling by over-volt. 1	2		The mains overvoltage 1 alarm can be linked to the mains decoupling function, if required.
			On	The mains overvoltage 1 trip is linked to the mains decoupling function with all its consequences.
			[Off]	The mains overvoltage 1 trip is ignored in the mains decoupling function.
			<b>Notes</b>	
		It is recommended to configure the operating limits (parameter 5810 ↗ p. 140 to 5817 ↗ p. 140) within the monitoring limits.		

#### 4.4.2.6 Mains Undervoltage (Level 1 & 2) ANSI# 27

##### General notes

Voltage is monitored depending on parameter "Mains voltage measuring" (parameter 1853 ↗ p. 98). There are two undervoltage alarm levels available in the control. Both alarms are definite time alarms and are illustrated in the figure below. The figure diagrams a frequency trend and the associated pickup times and length of the alarms. Monitoring of the voltage is done in two steps.



*If this protective function is triggered, the display indicates "Mains undervoltage 1" or "Mains undervoltage 2" and the logical command variable "07.12" or "07.13" will be enabled.*

Refer ↗ Chapter 9.1.1 "Triggering Characteristics" on page 551 for the triggering characteristic of this monitoring function.



*The mains undervoltage Level 2 limit configuration parameters are located below the mains decoupling function menu on the display.*

ID	Parameter	CL	Setting range [Default]	Description
3000 3006	Monitoring	2	[On]	Undervoltage monitoring is carried out according to the following parameters. Monitoring is performed at two levels. Both values may be configured independent from each other (prerequisite: Level 1 limit < Level 2 limit).
			Off	Monitoring is disabled for Level 1 limit and/or Level 2 limit.
3004 3010	Limit	2	10.0 to 150.0 % 3004: [92.0 %] 3010: [90.0 %] (Hysteresis: 0.7%)	The percentage values that are to be monitored for each threshold limit are defined here.  If this value is reached or exceeded for at least the delay time without interruption, the action specified by the alarm class is initiated.

ID	Parameter	CL	Setting range [Default]	Description
			(Reset Delay: 80 ms)	<p><b>Notes</b></p> <p>This value refers to the "Mains rated voltage" (parameter 1768 ↗ p. 95). Minimum value follows BDEW requirement.</p>
3005 3011	<b>Delay</b>	2	0.02 to 99.99 s 3005: <b>[1.50 s]</b> 3011: <b>[0.06 s]</b>	<p>If the monitored mains voltage falls below the threshold value for the delay time configured here, an alarm will be issued.</p> <p><b>Notes</b></p> <p>If the monitored mains voltage exceeds the threshold (plus the hysteresis) again before the delay expires the time will be reset.</p>
3001 3007	<b>Alarm class</b>	2	Class A/B/C/D/E/F, Control  3001: <b>[A]</b> 3007: <b>[B]</b>	<p>Each limit may be assigned an independent alarm class that specifies what action should be taken when the limit is surpassed.</p> <p><b>Notes</b></p> <p>For additional information refer to ↗ <i>Chapter 9.5.1 "Alarm Classes" on page 733</i></p>
3002 3008	<b>Self acknowl- edge</b>	2	<b>[Yes]</b>  No	<p>The control unit automatically clears the alarm if the fault condition is no longer detected.</p> <p>The control unit does not automatically reset the alarm when the fault condition is no longer detected.</p> <p>The alarm must be acknowledged and reset by manually pressing the appropriate buttons or by activating the LogicsManager output "External acknowledgment" (via a discrete input or via an interface).</p>
3003 3009	<b>Delayed by engine speed</b>	2	Yes  <b>[No]</b>	<p>Monitoring for fault conditions is not performed until engine delayed monitoring is enabled. The engine monitoring delay time (parameter 3315 ↗ p. 270) must expire prior to fault monitoring being enabled for parameters assigned this delay.</p> <p>Monitoring for this fault condition is continuously enabled regardless of engine speed.</p>
8844	<b>Mns. decou- pling by under- volt. 1</b>	2	 On  <b>[Off]</b>	<p>The mains undervoltage 1 alarm can be linked to the mains decoupling function, if required.</p> <p>The mains undervoltage 1 trip is linked to the mains decoupling function with all its consequences.</p> <p>The mains undervoltage 1 trip is ignored in the mains decoupling function.</p> <p><b>Notes</b></p> <p>It is recommended to configure the operating limits (parameter 5810 ↗ p. 140 to 5817 ↗ p. 140) within the monitoring limits.</p>

## 4.4.2.7 Mains Voltage Increase

### General notes

Voltage is monitored depending on parameter "Monitoring" (parameter 8806 ↗ p. 153). This function allows the monitoring of the voltage quality over a longer time period. It is realized as a 10 minute moving average. The function is only active, if mains is within the operating range. If "Mains voltage measuring" (parameter 1853 ↗ p. 98) is configured to a three-phase measurement,



the slow voltage increase alarm is monitoring the individual three-phase voltages of the mains according to parameter "AND characteristics" (parameter 8849 ↗ p. 154). The parameter "Mains decoupling volt. incr." (parameter 8808 ↗ p. 154) determines if a voltage increase shall trigger a mains decoupling or not.



*If this protective function is triggered, the display indicates "Mains volt. increase". The alarm can be incorporated into the mains decoupling function.*



*The average is set to "Mains rated voltage" (parameter 1768 ↗ p. 95) if:*

- Frequency is not in the operating range OR
- Monitoring (parameter 8806 ↗ p. 153) is "Off" OR
- Monitoring is "Delayed by engine speed" (parameter 8833 ↗ p. 154) OR
- Monitoring is tripped AND the measured voltage is again in the operating range

*Back synchronization is only possible, if:*

- The 10 minute average value is smaller than the defined limit AND
- The actual measured value is inside the operating range AND
- The mains settling time is over



*Please be aware that if "Mains voltage monitoring" (parameter 1771 ↗ p. 139) is configured to "All" and the mains voltage increase monitoring (parameter 8806 ↗ p. 153) is used, that this function only monitors "Phase - neutral".*

ID	Parameter	CL	Setting range [Default]	Description
8806	<b>Monitoring</b>	2	On	Voltage increase monitoring is carried out according to the following parameters.
			[Off]	No monitoring is carried out.
8807	<b>Limit</b>	2	100 to 150 %	The percentage voltage value that is to be monitored is defined here.
			[110 %]	If the average voltage over 10 minutes is higher, the action specified by the alarm class is initiated.
				<b>Notes</b> This value refers to the "Mains rated voltage" (parameter 1768 ↗ p. 95).
8831	<b>Alarm class</b>	2	Class A/B/C/D/E/F, Control [B]	Each limit may be assigned an independent alarm class that specifies what action should be taken when the limit is surpassed.

ID	Parameter	CL	Setting range [Default]	Description
				<b>Notes</b> For additional information refer to ↪ <i>Chapter 9.5.1 "Alarm Classes" on page 733</i>
8832	<b>Self acknowl- edge</b>	4	[Yes]	The control unit automatically clears the alarm if the fault condition is no longer detected.
			No	The control unit does not automatically reset the alarm when the fault condition is no longer detected.  The alarm must be acknowledged and reset by manually pressing the appropriate buttons or by activating the LogicsManager output "External acknowledgement" (via a discrete input or via an interface).
8833	<b>Delayed by engine speed</b>	2	Yes	Monitoring for fault conditions is not performed until engine delayed monitoring is enabled. The engine monitoring delay time (parameter 3315 ↪ p. 270) must expire prior to fault monitoring being enabled for parameters assigned this delay.
			[No]	Monitoring for this fault condition is continuously enabled regardless of engine speed.
8849	<b>AND character- istics</b>	2	On	If the 10 minute voltage averages of <b>all</b> phases exceed the limit, the monitoring is tripping.
			[Off]	If the 10 minute voltage average of <b>at least one</b> phase exceeds the limit, the monitoring is tripping.
8808	<b>Mns. decoupl. by volt. increase</b>	2	On	Voltage increase monitoring does cause a decoupling.
			[Off]	Voltage increase monitoring does not cause a decoupling.
8850	<b>Volt. incr. average</b>	0	—	This visualization value shows the current 10 minute average voltage.

#### 4.4.2.8 Mains Time-Dependent Voltage

##### General notes

Voltage is monitored depending on parameter "Mains voltage measuring" (parameter 1853 ↪ p. 98). This monitoring function is supporting a dynamic stabilization of mains. For this reason a FRT (Fault-Ride-Through) curve can be defined.

Furthermore it can be configured either as undervoltage or overvoltage monitoring (parameter 4953 ↪ p. 155). If the measured voltage of at least one phase (depends on the settings of parameter 4952 ↪ p. 155) falls below/exceeds the configured "Initial threshold" (parameter 4970 ↪ p. 156), the time-dependent voltage monitoring sequence starts and the voltage threshold will change in time according to the configured threshold curve points.

If the measured voltage falls below/exceeds this curve, the monitoring function triggers and LogicsManager 07.28 becomes TRUE. The mains decoupling function became active, if configured. If the measured voltage falls below/exceeds the configured "Fallback threshold" (parameter 4978 ↪ p. 156) for at least the configured "Fallback time" (parameter 4968 ↪ p. 156), the time-dependent voltage monitoring sequence will be reset.

The threshold curve results from seven configurable points and a linear interpolation between these points. Fig. 78 shows the default FRT curve for time-dependent voltage monitoring. The curve shows the device default values according to a typical grid code requirement.



The time points should always have an ascending order. The fallback threshold (parameter 4978 ↪ p. 156) should always be configured to a value higher/lower than the initial threshold (parameter 4970 ↪ p. 156).

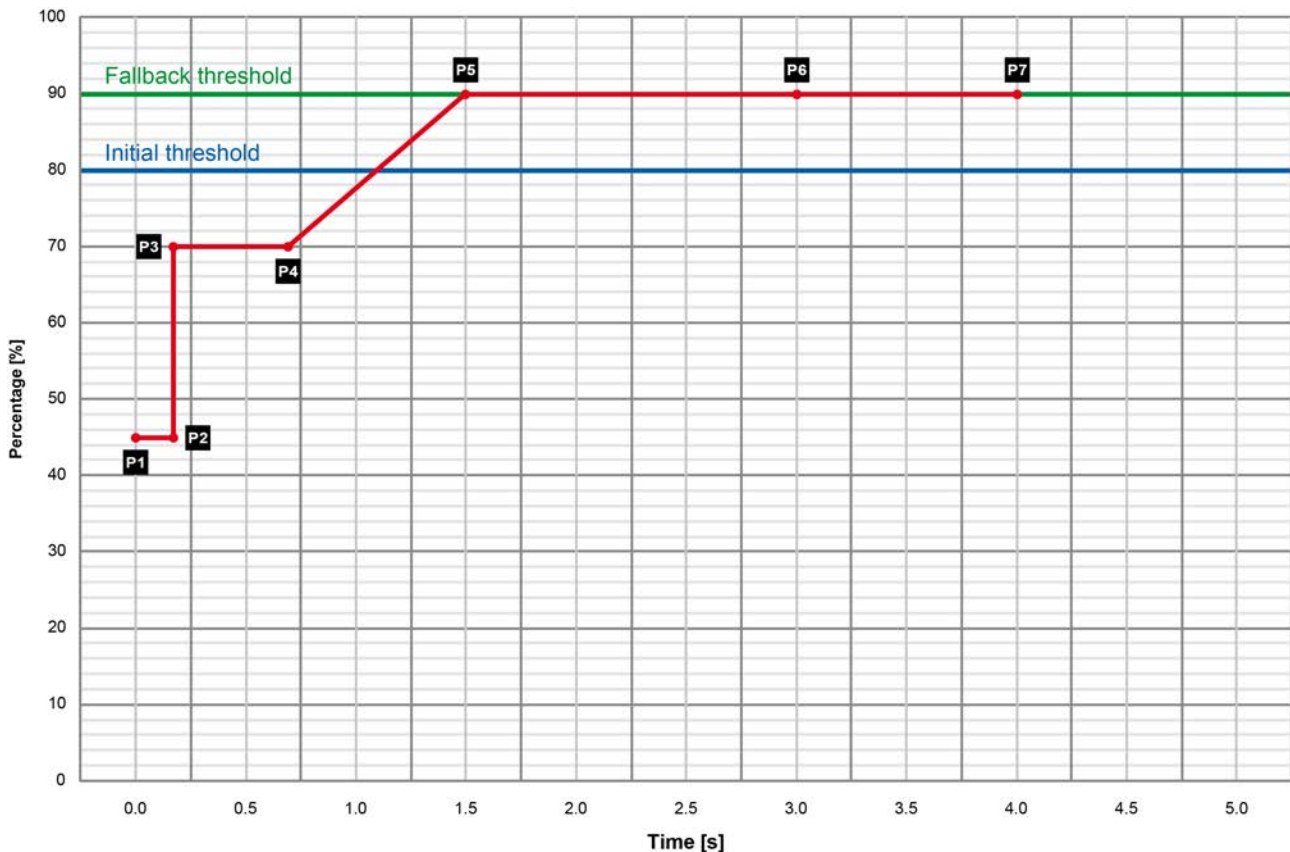

Fig. 78: Time-dependent voltage monitoring

P1	0.00 s → 45.0 %	P6	3.00 s → 90.0 %
P2	0.15 s → 45.0 %	P7	4.00 s → 90.0 %
P3	0.15 s → 70.0 %	Fallback threshold	90.0 %
P4	0.70 s → 70.0 %	Initial threshold	80.0 %
P5	1.50 s → 90.0 %	Fallback time	1.00 s

ID	Parameter	CL	Setting range [Default]	Description
4950	Monitoring	2	On	Time-dependent voltage monitoring is carried out according to the following parameters.
			[Off]	No monitoring is carried out.
4952	AND characteristics	2	On	Each phase falls below/exceeds the threshold for tripping.
			[Off]	At least one phase falls below/exceeds the threshold for tripping.
4953	Monitoring at	2		Selects whether the system shall do over- or undervoltage monitoring.

## Configuration

Configure Monitoring > Mains > Mains Time-Dependent Volta...

ID	Parameter	CL	Setting range [Default]	Description
			[Underrun]	The undervoltage monitoring is carried out (The monitoring function triggers if the measured voltage is below the curve).
			Overrun	The overvoltage monitoring is carried out (The monitoring function triggers if the measured voltage exceeds the curve).
4970	<b>Init threshold</b>	2	0.0 to 150.0 % [80.0 %]	The time-dependent voltage monitoring initial threshold is configured here. If the measured voltage falls below/exceeds this threshold, the monitoring sequence starts and the voltage threshold will change in time according to the configured threshold curve points.  If the measured voltage falls below/exceeds this curve, the monitoring function triggers and the configured relay will energize.
4978	<b>Fallback threshold</b>	2	0.0 to 150.0 % [90.0 %]	The time-dependent voltage monitoring fallback voltage is configured here. If the measured voltage falls below/exceeds the voltage configured here for at least the configured "Fallback time" (parameter 4968 ↗ p. 156), the monitoring sequence will be reset.
				<p><b>Notes</b></p> <p>This parameter should always be configured to a value higher/lower than the "Init threshold" (parameter 4970 ↗ p. 156) for proper operation.</p> <p>The parameter "Point 7 voltage" (parameter 4977 ↗ p. 156) is used as fallback threshold if it is configured to a value higher/lower than the parameter "Fallback threshold" (parameter 4978 ↗ p. 156).</p>
4968	<b>Fallback time</b>	2	0.00 to 320.00 s [1.00 s]	The time-dependent voltage monitoring fallback time is configured here. If the measured voltage falls below/exceeds the configured "Fallback threshold" (parameter 4978 ↗ p. 156) for at least the time configured here, the monitoring sequence will be reset.
4971 4972 4973 4974 4975 4976 4977	<b>Point {x} voltage</b> [x = 1 to 7]	2	0.0 to 150.0 % 4971: [45.0 %] 4972: [45.0 %] 4973: [70.0 %] 4974: [70.0 %] 4975: [90.0 %] 4976: [90.0 %] 4977: [90.0 %]	The voltage values of time-dependent voltage monitoring voltage points are configured here.
				<p><b>Notes</b></p> <p>Please avoid a setting between 0.1 % and 5.0 %.</p>
4961 4962 4963 4964 4965 4966 4967	<b>Point {x} time</b> [x = 1 to 7]	2	0.00 to 320.00 s 4961: [0.00 s] 4962: [0.15 s] 4963: [0.15 s] 4964: [0.70 s] 4965: [1.50 s] 4966: [3.00 s] 4967: [4.00 s]	The time values of time-dependent voltage monitoring time points are configured here.

ID	Parameter	CL	Setting range [Default]	Description
4951	Alarm class	2	Class A/B/C/D/E/F, Control	Each limit may be assigned an independent alarm class that specifies what action should be taken when the limit is surpassed.
			[B]	<b>Notes</b> For additional information refer to <a href="#">Chapter 9.5.1 "Alarm Classes"</a> on page 733
4959	Self acknowl- edge	2	[Yes]	The control unit automatically clears the alarm if the fault condition is no longer detected.
			No	The control unit does not automatically reset the alarm when the fault condition is no longer detected.  The alarm must be acknowledged and reset by manually pressing the appropriate buttons or by activating the LogicsManager output "External acknowledgement" (via a discrete input or via an interface).
4989	Mns. decoupl. by time-dep. volt.	2	On	Time-dependent voltage monitoring does cause a decoupling.
			[Off]	Time-dependent voltage monitoring does not cause a decoupling.

#### 4.4.2.9 QV Monitoring

##### General notes

In case of mains undervoltage some grid codes require a special monitoring function to avoid the import of inductive reactive power at the mains interchange point. The monitoring function measures close to the generator. For this reason the QV monitoring is a function of generator voltage and generator reactive power.

QV monitoring is triggered if the following conditions are fulfilled:  
(Refer to Fig. 79 for details)

- QV monitoring is configured to "On" (parameter 3292 [p. 158](#))
- Measured reactive power is higher than the configured "Reactive power threshold" (parameter 3291 [p. 158](#))
- Measured voltages are below the configured "Limit undervoltage" (parameter 3285 [p. 158](#))

As a result Timer 1 and Timer 2 are starting. If the delay time "Delay step 1" (parameter 3283 [p. 159](#)) has exceeded, LogicsManager 07.29 becomes TRUE and the corresponding alarm message "QV monitoring 1" is indicated. If the delay time "Delay step 2" (parameter 3284 [p. 159](#)) has exceeded, LogicsManager 07.30 becomes TRUE and the corresponding alarm message "QV monitoring 2" is indicated.

If parameter "Mains decoupling by QV" (parameter 3296 [p. 159](#)) is configured to "On" the decoupling function is assigned to "Delay step 1" (parameter 3283 [p. 159](#)).



- The LogicsManager command flags 07.29 and 07.30 can be additionally used to cause other actions according to the corresponding regulations of the grid.
- The QV Monitoring function according the German grid code VDE-AR-N 4105 depends on the parameter 1770 ↪ p. 109 "phase-phase/phase-neutral monitoring".

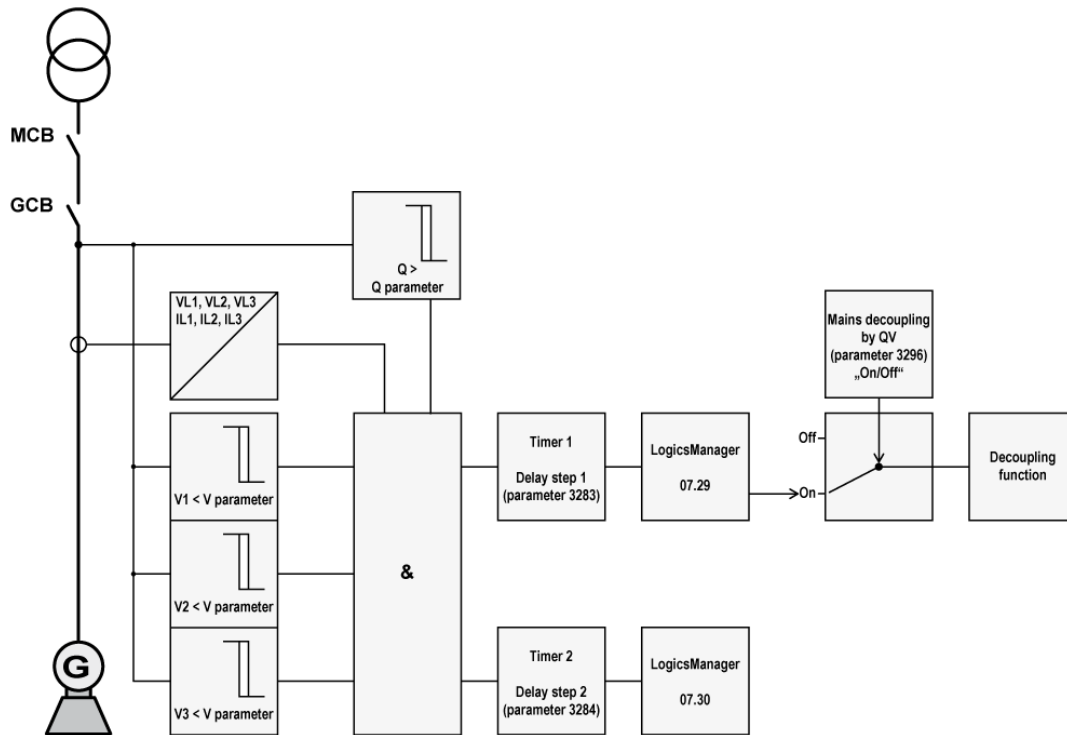

Fig. 79: QV monitoring - schematic

ID	Parameter	CL	Setting range [Default]	Description
3292	<b>Monitoring</b>	2	On	QV monitoring is carried out according to the following parameters.
			[Off]	No monitoring is carried out.
3285	<b>Limit under-voltage</b>	2	45 to 150 % [85 %]	The percentage voltage value that is to be monitored is defined here. If the voltages of all phases (one phase in 1Ph 2W system) are below this limit, the voltage condition for tripping the monitoring function is TRUE.
			<b>Notes</b>	This value refers to the "Generator rated voltage" (parameter 1766 ↪ p. 95).
3291	<b>Reactive power threshold</b>	2	2 to 100 % [5 %]	The percentage reactive value that is to be monitored is defined here. If the absolute value of reactive power Q is higher than this threshold, the reactive power condition for tripping the monitoring function is TRUE.

ID	Parameter	CL	Setting range [Default]	Description
				<b>Notes</b> This value refers to the "Gen. rated react. power [kvar]" (parameter 1758 ↗ p. 95).
3283	<b>Delay step 1</b>	2	0.10 to 99.99 s [0.50 s]	If the QV monitoring conditions are met, for the delay time configured here, an alarm "QV monitoring 1" will be issued and LogicsManager 07.29 becomes TRUE.
				<b>Notes</b> The decoupling function is only activated if "Mains decoupling by QV" (parameter 3296 ↗ p. 159) is configured to "On".
3284	<b>Delay step 2</b>	2	0.10 to 99.99 s [1.50 s]	If the QV monitoring conditions are met, for the delay time configured here, an alarm "QV monitoring 2" will be issued and LogicsManager 07.30 becomes TRUE.
3280	<b>Alarm class</b>	2	Class A/B/C/D/E/F, Control [B]	The alarm class specifies what action should be taken when at least one delay has been exceeded.
				<b>Notes</b> The alarm class is valid for parameter 3283 ↗ p. 159 and 3284 ↗ p. 159. For additional information refer to ↗ Chapter 9.5.1 "Alarm Classes" on page 733
3293	<b>Self acknowledge</b>	2	[Yes]	The control unit automatically clears the alarm if the fault condition is no longer detected.
			No	The control unit does not automatically reset the alarm when the fault condition is no longer detected. The alarm must be acknowledged and reset by manually pressing the appropriate buttons or by activating the LogicsManager output "External acknowledgement" (via a discrete input or via an interface).
				<b>Notes</b> The self acknowledge is valid for parameter 3283 ↗ p. 159 and 3284 ↗ p. 159.
3296	<b>Mains decoupling by QV</b>	2	On	The QV monitoring function is linked to the mains decoupling function with all its consequences and is assigned to "Delay step 1" (parameter 3283 ↗ p. 159).
			[Off]	The QV monitoring function is ignored in the mains decoupling function.

#### 4.4.2.10 Change Of Frequency

##### Phase shift

A vector/phase shift is defined as the sudden variation of the voltage curve which may be caused by a major generator load change. It usually occurs, if the utility opens the MCB, which causes a load change for the genset.

The easYgen measures the duration of a cycle, where a new measurement is started with each voltage passing through zero. The measured cycle duration will be compared with an internal quartz-calibrated reference time to determine the cycle duration difference of the voltage signal.

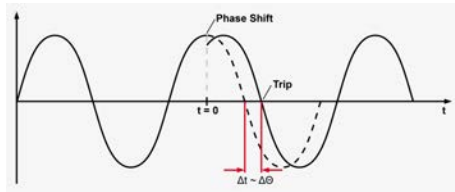

Fig. 80: Phase shift



The phase shift monitoring is a very sensitive functionality and reacts according to the settings on each sinus wave constellation.

Please be aware that under special circumstances it may come to a phase shift trip, when switching elements are taken into the mains measurement lines because mains voltage sensing lines are switched nearby the easYgen.

A vector/phase shift as shown in Fig. 80 causes a premature or delayed zero passage. The determined cycle duration difference corresponds with the occurring phase shift angle.

The monitoring may be carried out three-phased or one/three-phased. Different limits may be configured for one-phase and three-phase monitoring. The vector/phase shift monitor can also be used as an additional method to decouple from the mains. Vector/phase shift monitoring is only enabled after the monitored voltage exceeds 50 % of the PT secondary rated voltage.



**Function "Voltage cycle duration not within the permissible range"**

The voltage cycle duration exceeds the configured limit value for the phase/vector shift. The result is, that the power circuit breaker that disconnects from the mains, is opened, the message "Mains phase shift" is displayed, and the logical command variable "07.14" is enabled.

The prerequisite for phase/vector shift monitoring is that the generator is operating in a mains parallel operation (the MCB and GCB are both closed).

**df/dt (ROCOF)**

df/dt (rate of change of frequency) monitoring measures the stability of the frequency. The frequency of a source will vary due to changing loads and other effects. The rate of these frequency changes due to the load variances is relatively high compared to those of a large network.



**Function "Rate of change of frequency not within permissible limits"**

The control unit calculates the unit of measure per unit of time. The df/dt is measured over 4 sine waves to ensure that it is differentiated from a phase shift. This results in a minimum response time of approximately 100 ms (at 50 Hz).

ID	Parameter	CL	Setting range [Default]	Description
3058	Change of frequency	2	Off	Monitoring is disabled.
			[Phase shift]	Phase shift monitoring is carried out according to the parameters described in ☞ "Phase shift" on page 159.



ID	Parameter	CL	Setting range [Default]	Description
			df/dt	df/dt monitoring is carried out according to the parameters described in <a href="#">“df/dt (ROCOF)” on page 160</a> .
			Phase shift df/dt	Phase shift monitoring and df/dt monitoring is carried out. Tripping occurs if phase shift <b>or</b> df/dt is triggered.
3053	<b>Phase shift: Monitoring</b>	2	<b>[1- and 3 phase]</b>	During single-phase voltage phase/vector shift monitoring, tripping occurs if the phase/vector shift exceeds the configured threshold value (parameter 3054 <a href="#">p. 161</a> ) in at least one of the three phases.
			3 phase	During three-phase voltage phase/vector shift monitoring, tripping occurs only if the phase/vector shift exceeds the specified threshold value (parameter 3055 <a href="#">p. 161</a> ) in all three phases within 2 cycles.
			<b>Notes</b>	<p>If a phase/vector shift occurs in one or two phases, the single-phase threshold value (parameter 3054 <a href="#">p. 161</a>) is taken into consideration; if a phase/vector shift occurs in all three phases, the three-phase threshold value (parameter 3055 <a href="#">p. 161</a>) is taken into consideration. Single phase monitoring is very sensitive and may lead to nuisance tripping if the selected phase angle settings are too small.</p> <p>3 phase mains phase shift monitoring is only enabled if Mains voltage measuring (parameter 1853 <a href="#">p. 98</a>) is configured to "3Ph 4W" or "3Ph 3W".</p>
3054	<b>Phase shift: Limit 1 phase</b>	2	3 to 30° [20°]	<p>If the electrical angle of the mains voltage shifts more than this configured value in any single phase, an alarm with the class configured in parameter 3051 <a href="#">p. 161</a> is initiated.</p> <p>Depending on the configured mains decoupling procedure (parameter 3110 <a href="#">p. 141</a>), the GCB, MCB, or an external CB will be opened.</p>
3055	<b>Phase shift: Limit 3 phase</b>	2	3 to 30° [8°]	<p>If the electrical angle of the mains voltage shifts more than this configured value in all three phases, an alarm with the class configured in parameter 3051 <a href="#">p. 161</a> is initiated.</p> <p>Depending on the configured mains decoupling procedure (parameter 3110 <a href="#">p. 141</a>), the GCB, MCB, or an external CB will be opened.</p>
3051	<b>Phase shift: Alarm class</b>	2	Class A/B/C/D/E/F, Control [B]	<p>Each limit may be assigned an independent alarm class that specifies what action should be taken when the limit is surpassed.</p>
			<b>Notes</b>	<p>For additional information refer to <a href="#">Chapter 9.5.1 “Alarm Classes” on page 733</a>.</p>
3052	<b>Phase shift: Self acknowledge</b>	2	[Yes]	The control automatically clears the alarm if the fault condition is no longer detected.
			No	The control does not automatically reset the alarm when the fault condition is no longer detected. The alarm must be acknowledged and reset by manually pressing the appropriate buttons or by activating the LogicsManager output "External acknowledgment" (via a discrete input or via an interface).
3056	<b>Phase shift: Delayed by engine speed</b>	2	Yes	Monitoring for fault conditions is not performed until engine delayed monitoring is enabled. The engine monitoring delay time (parameter 3315 <a href="#">p. 270</a> ) must expire prior to fault monitoring being enabled for parameters assigned this delay.
			[No]	Monitoring for this fault condition is continuously enabled regardless of engine speed.

ID	Parameter	CL	Setting range [Default]	Description
3104	<b>df/dt: df/dt Limit</b>	2	0.1 to 9.9 Hz/s <b>[2.6 Hz/s]</b>  (Hysteresis: 0.1 Hz/s)  (Reset Delay: 80 ms)	<p>The df/dt threshold is defined here. If this value is reached or exceeded for at least the delay time without interruption, an alarm with the class configured in parameter 3101 ↗ p. 162 is initiated.</p> <p>Depending on the configured mains decoupling procedure (parameter 3110 ↗ p. 141), the GCB, MCB, or an external CB will be opened.</p>
3105	<b>df/dt: Delay</b>	2	0.10 to 2.00 s <b>[0.10 s]</b>	<p>If the monitored rate of df/dt exceeds the threshold value for the delay time configured here, an alarm will be issued.</p> <p>If the monitored df/dt exceeds the threshold (plus the hysteresis) again before the delay expires the time will be reset.</p>
3101	<b>df/dt: Alarm class</b>	2	Class A/B/C/D/E/F, Control <b>[B]</b>	<p>Each limit may be assigned an independent alarm class that specifies what action should be taken when the limit is surpassed.</p> <p><b>Notes</b></p> <p>For additional information refer to ↗ <i>Chapter 9.5.1 "Alarm Classes" on page 733.</i></p>
3102	<b>df/dt: Self acknowledge</b>	2	Yes	The control automatically clears the alarm if the fault condition is no longer detected.
			<b>[No]</b>	The control does not automatically reset the alarm when the fault condition is no longer detected. The alarm must be acknowledged and reset by manually pressing the appropriate buttons or by activating the LogicsManager output "External acknowledgment" (via a discrete input or via an interface).
3103	<b>df/dt: Delayed by engine speed</b>	2	Yes	Monitoring for fault conditions is not performed until engine delayed monitoring is enabled. The engine monitoring delay time (parameter 3315 ↗ p. 270) must expire prior to fault monitoring being enabled for parameters assigned this delay.
			<b>[No]</b>	Monitoring for this fault condition is continuously enabled regardless of engine speed.

#### 4.4.2.11 Mains Voltage Phase Rotation

##### General notes



##### NOTICE!

##### Damage to the control unit and/or generation equipment

- Please ensure during installation that all voltages applied to this unit are wired correctly to both sides of the circuit breaker.

Failure to do so may result in damage to the control unit and/or generation equipment due to closing the breaker asynchronous or with mismatched phase rotations and phase rotation monitoring enabled at all connected components (engine, generator, breakers, cable, busbars, etc.).

This function will block a connection of systems with mismatched phases only under the following conditions:

- The voltages being measured are wired correctly with respect to the phase rotation at the measuring points (i.e. the voltage transformer in front and behind the circuit breaker)
- The measuring voltages are wired without angular phase shift or interruption from the measuring point to the control unit
- The measuring voltages are wired to the correct terminals of the control unit (i.e. L1 of the generator is connected with the terminal of the control unit which is intended for the L1 of the generator)
- The LogicsManager function "Enable MCB" (refer to parameter 12923 ↗ p. 231) is false in case of a incorrect rotation field

Correct phase rotation of the phase voltages ensures that damage will not occur during a breaker closure to either the mains or the generator. The voltage phase rotation alarm checks the phase rotation of the voltages and the configured phase rotation to ensure they are identical.

The directions of rotation are differentiated as "clockwise" and "counter clockwise". With a clockwise field the direction of rotation is "L1-L2-L3"; with a counter clockwise field the direction of rotation is "L1-L3-L2".

If the control is configured for a clockwise rotation and the voltages into the unit are calculated as counterclockwise the alarm will be initiated. The direction of configured rotation being monitored by the control unit is displayed on the screen.



*If this protective function is triggered, the display indicates "Mns.ph.rot. mismatch" and the logical command variable "07.05" will be enabled.*



*This monitoring function is only enabled if Mains voltage measuring (parameter 1853 ↗ p. 98) is configured to "3Ph 4W" or "3Ph 3W" and the measured voltage exceeds 50 % of the rated voltage (parameter 1768 ↗ p. 95) or if Mains voltage measuring (parameter 1853 ↗ p. 98) is configured to "1Ph 2W" (in this case, the phase rotation is not evaluated, but defined by the 1Ph2W phase rotation (parameter 1859 ↗ p. 96)).*

ID	Parameter	CL	Setting range [Default]	Description
3970	<b>Monitoring</b>	2	[On]	Phase rotation monitoring is carried out according to the following parameters.
			Off	No monitoring is carried out.
3974	<b>Mains phase rotation</b>	2	[CW]	The three-phase measured mains voltage is rotating CW (clock-wise; that means the voltage rotates in L1-L2-L3 direction; standard setting).
			CCW	The three-phase measured mains voltage is rotating CCW (counter clock-wise; that means the voltage rotates in L1-L3-L2 direction).
3971	<b>Alarm class</b>	2	Class A/B/C/D/E/F, Control [B]	Each limit may be assigned an independent alarm class that specifies what action should be taken when the limit is surpassed.
				<p><b>Notes</b></p> <p>CAUTION: If an alarm class that leads to an engine shutdown (alarm class C or higher) is configured into this parameter, a main phase rotation alarm may lead to a genset shutdown due to an alarm of class C or higher.</p> <p>For additional information refer to ↗ Chapter 9.5.1 "Alarm Classes" on page 733</p>
3972	<b>Self acknowledge</b>	2	Yes	The control unit automatically clears the alarm if the fault condition is no longer detected.
			[No]	<p>The control unit does not automatically reset the alarm when the fault condition is no longer detected.</p> <p>The alarm must be acknowledged and reset by manually pressing the appropriate buttons or by activating the LogicsManager output "External acknowledgement" (via a discrete input or via an interface).</p>
3973	<b>Delayed by engine speed</b>	2	Yes	Monitoring for fault conditions is not performed until engine delayed monitoring is enabled. The engine monitoring delay time (parameter 3315 ↗ p. 270) must expire prior to fault monitoring being enabled for parameters assigned this delay.
			[No]	Monitoring for this fault condition is continuously enabled regardless of engine speed.

4.4.2.12 Mains Import Power (Level 1 & 2)

General notes

It is possible to monitor two independently configurable mains import power limit values. This function makes it possible to initiate external load shedding.



*If this protective function is triggered, the display indicates "Mains import power 1" or "Mains import power 2" and the logical command variable "07.21" or "07.22" will be enabled.*

ID	Parameter	CL	Setting range [Default]	Description
3200 3206	<b>Monitoring</b>	2	On	Mains import power monitoring is carried out according to the following parameters. Monitoring is performed at two levels. Both values may be configured independent from each other (prerequisite: Level 1 limit < Level 2 limit).
[Off]			Monitoring is disabled for Level 1 limit and/or Level 2 limit.	
3204 3210	<b>Limit</b>	2	0 to +150.00 % 3204: <b>[80.00 %]</b> 3210: <b>[100.00 %]</b>	If this threshold value has been exceeded or fallen below (depending on the setting of parameter 3215 ↪ p. 166 or 3216 ↪ p. 166) for at least the delay time (parameter 3205 ↪ p. 165 or 3211 ↪ p. 165), the action specified by the alarm class is initiated.  <b>Notes</b> This value refers to the Mains rated active power (parameter 1748 ↪ p. 95).
3213 3214			<b>Hysteresis</b>	2
3205 3211	<b>Delay</b>	2	0.02 to 99.99 s <b>[1.00 s]</b>	If the monitored mains import power falls below or exceeds (depending on the setting of parameter 3215 ↪ p. 166 or 3216 ↪ p. 166) the threshold value for the delay time configured here, an alarm will be issued.  <b>Notes</b> If the monitored mains import power exceeds or falls below the threshold (plus or minus the hysteresis configured in parameter 3213 ↪ p. 165 or 3214 ↪ p. 165) before the delay expires the time will be reset.
3201 3207			<b>Alarm class</b>	2
3202 3208	<b>Self acknowledge</b>	2	3202: <b>[Yes]</b>	The control unit automatically clears the alarm if the fault condition is no longer detected.
			3208: <b>[No]</b>	The control unit does not automatically reset the alarm when the fault condition is no longer detected.  The alarm must be acknowledged and reset by manually pressing the appropriate buttons or by activating the LogicsManager output "External acknowledgment" (via a discrete input or via an interface).
3203 3209	<b>Delayed by engine speed</b>	2	Yes	Monitoring for fault conditions is not performed until engine delayed monitoring is enabled. The engine monitoring delay time (parameter 3315 ↪ p. 270) must expire prior to fault monitoring being enabled for parameters assigned this delay.
			[No]	Monitoring for this fault condition is continuously enabled regardless of engine speed.

ID	Parameter	CL	Setting range [Default]	Description
3215	Monitoring at	2	[Overrun]	The monitored value must exceed the limit to be considered as out of limits.
3216			Underrun	The monitored value must fall below the limit to be considered as out of limits.

### 4.4.2.13 Mains Export Power (Level 1 & 2)

#### General notes

It is possible to monitor two independently configurable mains export power limit values. This function makes it possible to initiate external load shedding.



*If this protective function is triggered, the display indicates "Mains export power 1" or "Mains export power 2" and the logical command variable "07.23" or "07.24" will be enabled.*

ID	Parameter	CL	Setting range [Default]	Description
3225 3233	Monitoring	2	On	Mains export power monitoring is carried out according to the following parameters. Monitoring is performed at two levels. Both values may be configured independent from each other (prerequisite: Level 1 limit < Level 2 limit).
			[Off]	Monitoring is disabled for Level 1 limit and/or Level 2 limit.
3229 3237	Limit	2	0 to +150.00 % 3229: [80.00 %] 3237: [100.00 %]	If this threshold value has been exceeded or fallen below (depending on the setting of parameter 3232 ↗ p. 167 or 3240 ↗ p. 167) for at least the delay time (parameter 3230 ↗ p. 166 or 3238 ↗ p. 166), the action specified by the alarm class is initiated.
			<b>Notes</b>	This value refers to the Mains rated active power (parameter 1748 ↗ p. 95).
3231 3239	Hysteresis	2	0 to 99.99 % [0.01 %] (Reset Delay: 80 ms)	The monitored mains power level must return within the limits configured in parameter 3229 ↗ p. 166 or 3237 ↗ p. 166 plus or minus (depending on the setting of parameter 3232 ↗ p. 167 or 3240 ↗ p. 167) the value configured here, to reset the alarm.
3230 3238			Delay	2
	<b>Notes</b>	If the monitored mains import power exceeds or falls below the threshold (plus or minus the hysteresis configured in parameter 3231 ↗ p. 166 or 3239 ↗ p. 166) before the delay expires the time will be reset.		
3226 3234	Alarm class	2	Class A/B/C/D/E/F, Control 3226: [A] 3234: [B]	Each limit may be assigned an independent alarm class that specifies what action should be taken when the limit is surpassed.
			<b>Notes</b>	For additional information refer to ↗ Chapter 9.5.1 "Alarm Classes" on page 733

ID	Parameter	CL	Setting range [Default]	Description
3227 3235	Self acknowledge	2	3227: [Yes]	The control unit automatically clears the alarm if the fault condition is no longer detected.
3235: [No]			The control unit does not automatically reset the alarm when the fault condition is no longer detected.  The alarm must be acknowledged and reset by manually pressing the appropriate buttons or by activating the LogicsManager output "External acknowledgment" (via a discrete input or via an interface).	
3228 3236	Delayed by engine speed	2	Yes	Monitoring for fault conditions is not performed until engine delayed monitoring is enabled. The engine monitoring delay time (parameter 3315 ↗ p. 270) must expire prior to fault monitoring being enabled for parameters assigned this delay.
			[No]	Monitoring for this fault condition is continuously enabled regardless of engine speed.
3232 3240	Monitoring at	2	[Overrun]	The monitored value must exceed the limit to be considered as out of limits.
			Underrun	The monitored value must fall below the limit to be considered as out of limits.

#### 4.4.2.14 Mains Lagging Power Factor (Level 1 & 2)

##### General notes

The power factor is monitored for becoming more lagging (i.e. inductive) than an adjustable limit. This limit may be a lagging or leading power factor limit. There are two lagging power factor alarm levels available in the control. This monitoring function may be used for monitoring or controlling the power factor compensation. Both alarms are definite time alarms.

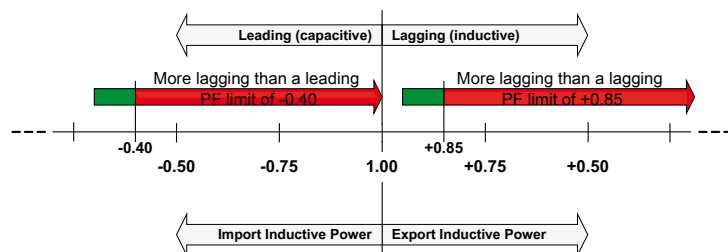

Fig. 81: Mains lagging power factor

Fig. 81 shows an example of a leading and a lagging power factor limit and the power factor range, for which the lagging power factor monitoring issues an alarm.



If this protective function is triggered, the display indicates "Mains PF lagging 1" or "Mains PF lagging 2" and the logical command variable "07.17" or "07.18" will be enabled.

## Configuration

Configure Monitoring > Mains > Mains Lagging Power Factor...

ID	Parameter	CL	Setting range [Default]	Description
2975 2980	<b>Monitoring</b>	2	On	Mains lagging power factor monitoring is carried out according to the following parameters. Monitoring is performed at two levels. Both values may be configured independent from each other.
[Off]			Monitoring is disabled for Level 1 limit and/or Level 2 limit.	
2978 2983	<b>Limit</b>	2	-0.999 to 1.000 2978: <b>[+ 0.900]</b> 2983: <b>[+ 0.800]</b>	The values that are to be monitored for each threshold limit are defined here.  <b>Notes</b> If the power factor becomes more lagging (i.e. inductive, Fig. 81) than a lagging PF value (pos.) or a leading PF value (neg.) for at least the delay time (parameters 2979 ↗ p. 168 or 2984 ↗ p. 168) without interruption, the logical command variables 07.17 (level 1) or 07.18 (level 2) are enabled and the action specified by the alarm class is initiated.
2989 2990			<b>Hysteresis</b>	2
2979 2984	<b>Delay</b>	2	0.02 to 99.99 s 2979: <b>[30.00 s]</b> 2984: <b>[1.00 s]</b>	If the monitored generator power factor is more lagging than the configured limit for the delay time configured here, an alarm will be issued.  <b>Notes</b> If the monitored generator power factor returns within the limit (minus the Hysteresis configured in parameter 2989 ↗ p. 168 or 2990 ↗ p. 168) before the delay expires the time will be reset.
2987 2988			<b>Alarm class</b>	2
2976 2981	<b>Self acknowledge</b>	2	Yes	The control unit automatically clears the alarm if the fault condition is no longer detected.
[No]			The control unit does not automatically reset the alarm when the fault condition is no longer detected.  The alarm must be acknowledged and reset by manually pressing the appropriate buttons or by activating the LogicsManager output "External acknowledgment" (via a discrete input or via an interface).	
2977 2982	<b>Delayed by engine speed</b>	2	Yes	Monitoring for fault conditions is not performed until engine delayed monitoring is enabled. The engine monitoring delay time (parameter 3315 ↗ p. 270) must expire prior to fault monitoring being enabled for parameters assigned this delay.
[No]			Monitoring for this fault condition is continuously enabled regardless of engine speed.	



### 4.4.2.15 Mains Leading Power Factor (Level 1 & 2)

#### General notes

The power factor is monitored for becoming more leading (i.e. capacitive) than an adjustable limit. This limit may be a leading or lagging power factor limit. There are two leading power factor alarm levels available in the control. This monitoring function may be used for monitoring or controlling the power factor compensation. Both alarms are definite time alarms.

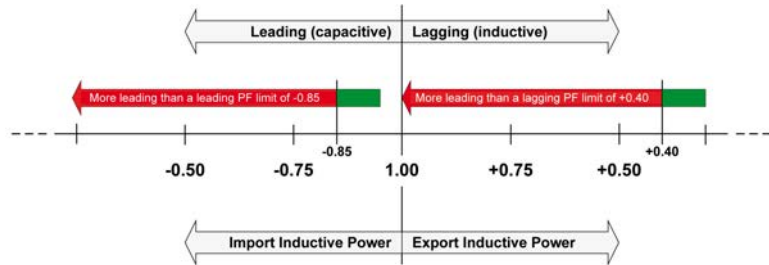

Fig. 82: Mains leading power factor

Fig. 82 shows an example of a leading and a lagging power factor limit and the power factor range, for which the leading power factor monitoring issues an alarm.



If this protective function is triggered, the display indicates "Mains PF leading 1" or "Mains PF leading 2" and the logical command variable "07.19" or "07.20" will be enabled.

ID	Parameter	CL	Setting range [Default]	Description
3025 3030	<b>Monitoring</b>	2	On	Mains leading power factor monitoring is carried out according to the following parameters. Monitoring is performed at two levels. Both values may be configured independent from each other.
			[Off]	Monitoring is disabled for Level 1 limit and/or Level 2 limit.
3028 3033	<b>Limit</b>	2	-0.999 to 01.000	The values that are to be monitored for each threshold limit are defined here.
			3028: [- 0.900] 3033: [- 0.800]	<b>Notes</b> If the power factor becomes more leading (i.e. inductive, Fig. 82) than a leading PF value (pos.) or a leading PF value (neg.) for at least the delay time (parameters 3029 ↪ p. 169 or 3034 ↪ p. 169) without interruption, the logical command variables 07.17 (level 1) or 07.18 (level 2) are enabled and the action specified by the alarm class is initiated.
3039 3040	<b>Hysteresis</b>	2	0.0 to 0.99 [0.02] (Reset Delay: 80 ms)	The monitored power factor must return within the limits configured in parameter 3028 ↪ p. 169 or 3033 ↪ p. 169 minus the value configured here, to reset the alarm.
3029 3034			<b>Delay</b>	2
	<b>Notes</b> If the monitored generator power factor returns within the limit (minus the Hysteresis configured in parameter 3039 ↪ p. 169 or 3033 ↪ p. 169) before the delay expires the time will be reset.			

ID	Parameter	CL	Setting range [Default]	Description
3037 3038	<b>Alarm class</b>	2	Class A/B/C/D/E/F, Control	Each limit may be assigned an independent alarm class that specifies what action should be taken when the limit is surpassed.
[B]			<b>Notes</b> For additional information refer to ↪ <i>Chapter 9.5.1 "Alarm Classes" on page 733</i>	
3026 3031	<b>Self acknowledge</b>	2	Yes	The control unit automatically clears the alarm if the fault condition is no longer detected.
[No]			The control unit does not automatically reset the alarm when the fault condition is no longer detected.  The alarm must be acknowledged and reset by manually pressing the appropriate buttons or by activating the LogicsManager output "External acknowledgment" (via a discrete input or via an interface).	
3027 3032	<b>Delayed by engine speed</b>	2	Yes	Monitoring for fault conditions is not performed until engine delayed monitoring is enabled. The engine monitoring delay time (parameter 3315 ↪ p. 270) must expire prior to fault monitoring being enabled for parameters assigned this delay.
[No]			Monitoring for this fault condition is continuously enabled regardless of engine speed.	

## 4.4.2.16 Blocking of Mains Protection

### General notes

The operator can deactivate the mains monitoring features and the decoupling function. A dedicated LogicsManager is installed to disable all mains monitoring and the decoupling function.



*Already latched alarms (self acknowledge = No) are not removed from the alarm list by this function.*

Following functions are blocked:

- Mains decoupling
- Mains over frequency 1&2
- Mains under frequency 1&2
- Mains over voltage 1&2
- Mains under voltage 1&2
- Mains voltage increase (10 minutes average value)
- Mains Time-dependent Voltage (FRT)
- Mains Q(V) Monitoring
- Mains phase shift
- Mains df/dt

ID	Parameter	CL	Setting range [Default]	Description
15159	<b>Disable mains monitoring</b>	2	Determined by LogicsManager [[0 & 1] & 1] t <sub>ON</sub> = 0.00; t <sub>OFF</sub> = 0.00]	Switch to disable <ul style="list-style-type: none"> <li>■ all mains monitoring functions and</li> <li>■ the mains decoupling function.</li> </ul>

### 4.4.3 Engine

#### 4.4.3.1 Engine Overspeed (Level 1 & 2) ANSI# 12

##### General notes

The speed measured by the magnetic pickup unit (MPU) is monitored for overspeed. If the MPU is disabled, the speed may only be monitored using the generator overfrequency monitoring. If the MPU speed exceeds the overspeed limits the configured alarms will be initiated.



*If this protective function is triggered, the display indicates "Overspeed 1" or "Overspeed 2" and the logical command variable "05.01" or "05.02" will be enabled.*

Refer to [Chapter 9.1.1 "Triggering Characteristics"](#) on page 551 for the triggering characteristic of this monitoring function.

ID	Parameter	CL	Setting range [Default]	Description
2100 2106	<b>Monitoring</b>	2	[On]  Off	Overspeed monitoring is carried out according to the following parameters. Monitoring is performed at two levels. Both values may be configured independent from each other (prerequisite: Level 1 > Level 2).  Monitoring is disabled for Level 1 limit and/or Level 2 limit.
2104 2110	<b>Limit</b>	2	0 to 9,999 rpm 2104: [1,850.0 rpm] 2110: [1,900.0 rpm] (Hysteresis: 50 rpm) (Reset Delay: 1 s)	The revolutions per minute (rpm) values that are to be monitored for each threshold limit are defined here.  If this value is reached or exceeded for at least the delay time without interruption, the action specified by the alarm class is initiated.
2105 2111	<b>Delay</b>	2	0.02 to 99.99 s 2105: [1.00 s] 2111: [0.10 s]	If the monitored engine speed exceeds the threshold value for the delay time configured here, an alarm will be issued.  <b>Notes</b> If the monitored engine speed falls below the threshold (minus the hysteresis) before the delay expires the time will be reset.
2101 2107	<b>Alarm class</b>	2	Class A/B/C/D/E/F, Control 2101: [B]	Each limit may be assigned an independent alarm class that specifies what action should be taken when the limit is surpassed.

ID	Parameter	CL	Setting range [Default]	Description
			2107: [F]	<b>Notes</b> For additional information refer to <a href="#">Chapter 9.5.1 "Alarm Classes" on page 733</a>
2102 2108	<b>Self acknowledge</b>	2	Yes	The control unit automatically clears the alarm if the fault condition is no longer detected.
[No]			The control unit does not automatically reset the alarm when the fault condition is no longer detected.  The alarm must be acknowledged and reset by manually pressing the appropriate buttons or by activating the LogicsManager output "External acknowledgment" (via a discrete input or via an interface).	
2103 2109	<b>Delayed by engine speed</b>	2	Yes	Monitoring for fault conditions is not performed until engine delayed monitoring is enabled. The engine monitoring delay time (parameter 3315 <a href="#">p. 270</a> ) must expire prior to fault monitoring being enabled for parameters assigned this delay.
[No]			Monitoring for this fault condition is continuously enabled regardless of engine speed.	

#### 4.4.3.2 Engine Underspeed (Level 1 & 2)

##### General notes

The speed measured by the magnetic pickup unit (MPU) is monitored for underspeed. If the MPU is disabled or not available, the speed may only be monitored using the generator underfrequency monitoring. If the MPU speed falls below the underspeed limits the configured alarms will be initiated.



*If this protective function is triggered, the display indicates "Underspeed 1" or "Underspeed 2" and the logical command variable "05.03" or "05.04" will be enabled.*

Refer to [Chapter 9.1.1 "Triggering Characteristics" on page 551](#) for the triggering characteristic of this monitoring function.

ID	Parameter	CL	Setting range [Default]	Description
2150 2156	<b>Monitoring</b>	2	[On]	Underspeed monitoring is carried out according to the following parameters. Monitoring is performed at two levels. Both values may be configured independent from each other (prerequisite: Level 1 > Level 2).
Off			Monitoring is disabled for Level 1 limit and/or Level 2 limit.	

ID	Parameter	CL	Setting range [Default]	Description
2154 2160	Limit	2	0 to 9999 rpm 2154: <b>[1,300.0 rpm]</b> 2160: <b>[1,250.0 rpm]</b>  (Hysteresis: 50 rpm)  (Reset Delay: 1 s)	The percentage values that are to be monitored for each threshold limit are defined here.  If this value is reached or exceeded for at least the delay time without interruption, the action specified by the alarm class is initiated.
2155 2161			0.02 to 99.99 s 2155: <b>[1.00 s]</b> 2161: <b>[0.10 s]</b>	If the monitored engine speed falls below the threshold value for the delay time configured here, an alarm will be issued.  <b>Notes</b> If the monitored engine speed exceeds the threshold (plus the hysteresis) again before the delay expires the time will be reset.
2151 2157	Alarm class	2	Class A/B/C/D/E/F, Control  2151: <b>[B]</b> 2157: <b>[F]</b>	Each limit may be assigned an independent alarm class that specifies what action should be taken when the limit is surpassed.  <b>Notes</b> For additional information refer to <a href="#">Chapter 9.5.1 "Alarm Classes"</a> on page 733
2152 2158			Yes  <b>[No]</b>	The control unit automatically clears the alarm if the fault condition is no longer detected.  The control unit does not automatically reset the alarm when the fault condition is no longer detected.  The alarm must be acknowledged and reset by manually pressing the appropriate buttons or by activating the LogicsManager output "External acknowledgment" (via a discrete input or via an interface).
2153 2159	Delayed by engine speed	2	<b>[Yes]</b>	Monitoring for fault conditions is not performed until engine delayed monitoring is enabled. The engine monitoring delay time (parameter 3315 <a href="#">p. 270</a> ) must expire prior to fault monitoring being enabled for parameters assigned this delay.
			No	Monitoring for this fault condition is continuously enabled regardless of engine speed.

#### 4.4.3.3 Engine/Generator Speed Detection

##### General notes

Speed detection checks if the generator voltage frequency  $f$  (determined from the measured generator voltage) differs from the measured engine speed  $n$  (determined from the Pickup signal) and determines a difference ( $\Delta f-n$ ).

If the two frequencies are not identical ( $\Delta f-n \neq 0$ ) and the monitored frequency mismatch reaches or exceeds the threshold, an alarm is output. Additionally the LogicsManager output "Firing speed" is checked upon its logical status with respect to the measuring values "generator frequency" and "Pickup speed".



*If this protective function is triggered, the display indicates "Speed/freq. mismatch" and the logical command variable "05.07" will be enabled.*



*Speed/frequency mismatch (n/f mismatch) is carried out only if an MPU is connected to the control and parameter "Speed pickup" (parameter 1600 ↗ p. 274), is configured On. The following is valid:*

*The measurement via Pickup is enabled (On):*

*Mismatch monitoring is carried out using the engine speed from the Pickup and the generator frequency. If the speed/frequency mismatch or the LogicsManager is enabled and the frequency is outside of the configured limit, an alarm will be issued.*

*The measurement via Pickup is disabled (Off):*

*Mismatch monitoring is carried out using the generator frequency and the LogicsManager. If the LogicsManager output is enabled and the frequency is outside of the configured limit, an alarm will be issued.*

ID	Parameter	CL	Setting range [Default]	Description
2450	<b>Monitoring</b>	2	[On]	Monitoring of the speed/frequency/LogicsManager mismatch (n/f/LM mismatch) is carried out according to the following parameters.
			Off	Monitoring is disabled.
2454	<b>Speed/ frequency mis- match limit</b>	2	1.5 to 8.5 Hz [5.0 Hz]	The frequency mismatch that is to be monitored is defined here.  If the monitored frequency mismatch reaches or exceeds this value for at least the delay time without interruption, the action specified by the alarm class is initiated.
				<b>Notes</b> The LogicsManager is monitored with respect to his status.
2455	<b>Delay</b>	2	0.02 to 99.99 s [2.00 s]	If the monitored frequency mismatch exceeds the threshold value for the delay time configured here, an alarm will be issued.
				<b>Notes</b> If the monitored frequency mismatch falls below the threshold (minus the hysteresis) before the delay expires the time will be reset.
2453	<b>Activation frequency</b>	2	15 to 85 Hz [20 Hz]	The speed/frequency mismatch monitoring is enabled at this generator frequency.
2451	<b>Alarm class</b>	2	Class A/B/C/D/E/F, Control [E]	Each limit may be assigned an independent alarm class that specifies what action should be taken when the limit is surpassed.
				<b>Notes</b> For additional information refer to ↗ Chapter 9.5.1 "Alarm Classes" on page 733

ID	Parameter	CL	Setting range [Default]	Description
2452	Self acknowledge	2	Yes	The control unit automatically clears the alarm if the fault condition is no longer detected.
			[No]	The control unit does not automatically reset the alarm when the fault condition is no longer detected.  The alarm must be acknowledged and reset by manually pressing the appropriate buttons or by activating the LogicsManager output "External acknowledgement" (via a discrete input or via an interface).

#### 4.4.3.4 Engine/Generator Active Power Mismatch

##### General notes

If enabled, this monitoring function becomes only active if generator power control is enabled (refer to [Chapter 4.5.12.2 "Load Control" on page 308](#)). If the measured generator power deviates from the power setpoint by a value exceeding the limit configured in parameter 2925 [p. 175](#) for a time exceeding the delay configured in parameter 2923 [p. 175](#), an alarm will be issued.



*If this protective function is triggered, the display indicates "Gen act.pwr mismatch" and the logical command variable "06.29" will be enabled.*

ID	Parameter	CL	Setting range [Default]	Description
2920	Monitoring	2	[On]	Monitoring of the generator active power mismatch is carried out according to the following parameters.
			Off	Monitoring is disabled.
2925	Limit	2	0.0 to 30.0 % [5.0 %]	If the difference between the measured generator power and the power setpoint exceeds this value for at least the delay time (parameter 2923 <a href="#">p. 175</a> ) without interruption, the action specified by the alarm class is initiated.
			<b>Notes</b>	This value refers to the generator rated active power (parameter 1752 <a href="#">p. 95</a> ).
2923	Delay	2	3 to 65000 s [30 s]	If the monitored active power mismatch exceeds the threshold value configured in parameter 2925 <a href="#">p. 175</a> for the delay time configured here, an alarm will be issued.
			<b>Notes</b>	If the monitored active power mismatch falls below the threshold (minus the hysteresis) before the delay expires the time will be reset.
2921	Alarm class	2	Class A/B/C/D/E/F, Control [B]	Each limit may be assigned an independent alarm class that specifies what action should be taken when the limit is surpassed.
			<b>Notes</b>	For additional information refer to <a href="#">Chapter 9.5.1 "Alarm Classes" on page 733</a>

ID	Parameter	CL	Setting range [Default]	Description
2922	Self acknowledge	2	Yes	The control unit automatically clears the alarm if the fault condition is no longer detected.
			[No]	The control unit does not automatically reset the alarm when the fault condition is no longer detected.  The alarm must be acknowledged and reset by manually pressing the appropriate buttons or by activating the LogicsManager output "External acknowledgement" (via a discrete input or via an interface).

### 4.4.3.5 Engine/Mains Active Power Mismatch

#### General notes

If enabled, this monitoring function becomes only active if generator power control is enabled and the active power setpoint is configured to "Import" or "Export" (refer to [Chapter 4.5.12.2 "Load Control" on page 308](#)). If the measured import or export power deviates from the power setpoint by a value exceeding the limit configured in parameter 2935 [p. 176](#) for a time exceeding the delay configured in parameter 2933 [p. 176](#), an alarm will be issued.



*If this protective function is triggered, the display indicates "Mns act.pwr mismatch" and the logical command variable "07.16" will be enabled.*

ID	Parameter	CL	Setting range [Default]	Description
2930	Monitoring	2	[On]	On Monitoring of the mains active power mismatch is carried out according to the following parameters.
			Off	Monitoring is disabled.
2935	Limit	2	1.0 to 99.9 % [5.0 %]	If the difference between the measured import or export power and the power setpoint exceeds this value for at least the delay time (parameter 2933 <a href="#">p. 176</a> ) without interruption, the action specified by the alarm class is initiated.
			<b>Notes</b>	This value refers to the mains rated active power (parameter 1748 <a href="#">p. 95</a> ).
2933	Delay	2	3 to 65000 s [30 s]	If the monitored active power mismatch exceeds the threshold value configured in parameter 2935 <a href="#">p. 176</a> for the delay time configured here, an alarm will be issued.
			<b>Notes</b>	If the monitored active power mismatch falls below the threshold (minus the hysteresis) before the delay expires the time will be reset.
2931	Alarm class	2	Class A/B/C/D/E/F, Control [B]	Each limit may be assigned an independent alarm class that specifies what action should be taken when the limit is surpassed.



ID	Parameter	CL	Setting range [Default]	Description
				<b>Notes</b> For additional information refer to <a href="#">Chapter 9.5.1 "Alarm Classes"</a> on page 733
2932	<b>Self acknowledge</b>	2	Yes	The control unit automatically clears the alarm if the fault condition is no longer detected.
			[No]	The control unit does not automatically reset the alarm when the fault condition is no longer detected.  The alarm must be acknowledged and reset by manually pressing the appropriate buttons or by activating the LogicsManager output "External acknowledgement" (via a discrete input or via an interface).

#### 4.4.3.6 Engine/Generator Unloading Mismatch

##### General notes

This monitoring function is always enabled and becomes active when a stop command is issued. Following a stop command, the controller tries to reduce the power before opening the GCB. If the power falls below the unload limit (parameter 3125 [p. 177](#)) before the delay (parameter 3123 [p. 177](#)) expires, a "GCB open" command will be issued. If the controller fails to reduce the power to fall below the unload limit (parameter 3125 [p. 177](#)) before the delay (parameter 3123 [p. 177](#)) expires, a "GCB open" command will be issued together with an alarm.



*If this protective function is triggered, the display indicates "Gen. unloading fault" and the logical command variable "06.30" will be enabled.*

ID	Parameter	CL	Setting range [Default]	Description
3125	<b>Unload limit</b>	2	0.5 to 99.9 % [3.0 %]	If the monitored generator power falls below this value, a "GCB open" command will be issued.
				<b>Notes</b> This value refers to the generator rated active power (parameter 1752 <a href="#">p. 95</a> ).
3123	<b>Delay</b>	2	2 to 9999 s [60 s]	If the monitored generator power does not fall below the limit configured in parameter 3125 <a href="#">p. 177</a> before the time configured here expires, a "GCB open" command will be issued together with an alarm.
3121	<b>Alarm class</b>	2	Class A/B/C/D/E/F, Control [B]	Each limit may be assigned an independent alarm class that specifies what action should be taken when the limit is surpassed.
				<b>Notes</b> For additional information refer to <a href="#">Chapter 9.5.1 "Alarm Classes"</a> on page 733

ID	Parameter	CL	Setting range [Default]	Description
3122	Self acknowledge	2	Yes	The control unit automatically clears the alarm if the fault condition is no longer detected.
			[No]	The control unit does not automatically reset the alarm when the fault condition is no longer detected.  The alarm must be acknowledged and reset by manually pressing the appropriate buttons or by activating the LogicsManager output "External acknowledgement" (via a discrete input or via an interface).

### 4.4.3.7 Engine Start Failure

#### General notes

If it is not possible to start the engine within a configured number of start attempts (refer to [Chapter 4.5.9.2 "Engine Start/Stop" on page 267](#)), an alarm will be initiated.



*If this protective function is triggered, the display indicates "Start fail" and the logical command variable "05.08" will be enabled.*

ID	Parameter	CL	Setting range [Default]	Description
3303	Monitoring	2	[On]	Monitoring of the start sequence is carried out according to the following parameters.
			Off	Monitoring is disabled.
3304	Alarm class	2	Class A/B/C/D/E/F, Control	Each limit may be assigned an independent alarm class that specifies what action should be taken when the limit is surpassed.
			[F]	<b>Notes</b> For additional information refer to <a href="#">Chapter 9.5.1 "Alarm Classes" on page 733</a>
3305	Self acknowledge	2	Yes	The control unit automatically clears the alarm if the fault condition is no longer detected.
			[No]	The control unit does not automatically reset the alarm when the fault condition is no longer detected.  The alarm must be acknowledged and reset by manually pressing the appropriate buttons or by activating the LogicsManager output "External acknowledgement" (via a discrete input or via an interface).

### 4.4.3.8 Engine Shutdown Malfunction

#### General notes

If it is not possible to stop the engine within a configured time, an alarm will be initiated.



*If this protective function is triggered, the display indicates "Eng. stop malfunct." and the logical command variable "05.06" will be enabled.*



*We recommend to assign this monitoring function to a discrete output to be able to shutdown the engine with an external device to provide a shutdown redundancy.*

ID	Parameter	CL	Setting range [Default]	Description
2500	Monitoring	2	[On]	Monitoring of the stop sequence is carried out according to the following parameters.
			Off	Monitoring is disabled.
2503	Maximum stop delay	2	3 to 999 s [30 s]	The maximum permissible time between the output of a stop command and the reply that the engine is stopped successfully is defined here.
				<b>Notes</b> If the engine cannot be stopped within this time (this means speed via the Pickup, frequency via the generator voltage, or the LogicsManager is detected) the action specified by the alarm class is initiated.
2501	Alarm class	2	Class A/B/C/D/E/F, Control [F]	Each limit may be assigned an independent alarm class that specifies what action should be taken when the limit is surpassed.
				<b>Notes</b> For additional information refer to <a href="#">Chapter 9.5.1 "Alarm Classes" on page 733</a>
2502	Self acknowledge	2	Yes	The control unit automatically clears the alarm if the fault condition is no longer detected.
			[No]	The control unit does not automatically reset the alarm when the fault condition is no longer detected.  The alarm must be acknowledged and reset by manually pressing the appropriate buttons or by activating the LogicsManager output "External acknowledgement" (via a discrete input or via an interface).

#### 4.4.3.9 Engine Unintended Stop

##### General notes

If an engine stop has been detected without a stop command being issued, an alarm will be initiated.



*If this protective function is triggered, the display indicates "Unintended stop" and the logical command variable "05.05" will be enabled.*

ID	Parameter	CL	Setting range [Default]	Description
2650	Monitoring	2	[On]	Monitoring of an unintended stop is carried out according to the following parameters.
			Off	Monitoring is disabled.
2651	Alarm class	2	Class A/B/C/D/E/F, Control [F]	Each limit may be assigned an independent alarm class that specifies what action should be taken when the limit is surpassed.
				<b>Notes</b> For additional information refer to <a href="#">Chapter 9.5.1 "Alarm Classes" on page 733</a>
2657	Self acknowledge	2	Yes	The control unit automatically clears the alarm if the fault condition is no longer detected.
			[No]	The control unit does not automatically reset the alarm when the fault condition is no longer detected.  The alarm must be acknowledged and reset by manually pressing the appropriate buttons or by activating the LogicsManager output "External acknowledgement" (via a discrete input or via an interface).

#### 4.4.3.10 Engine Operating Range Failure

##### General notes

The operating range failure monitoring issues an alarm if one of the following conditions is fulfilled:

- Check 1: The easYgen tries to close the GCB, but the generator is not within its operating range (parameters 5800 [p. 110](#), 5801 [p. 110](#), 5802 [p. 110](#), or 5803 [p. 110](#)).
- Check 2: The easYgen tries to synchronize the GCB, but the busbar or the generator is not within the generator operating range (parameters 5800 [p. 110](#), 5801 [p. 110](#), 5802 [p. 110](#), or 5803 [p. 110](#)).
- Check 3a: The easYgen tries to close the GCB to the dead busbar, but the busbar voltage is NOT below the dead busbar detection limit (parameter 5820 [p. 224](#)).
- Check 3b: The easYgen sees no neighbor GCB closed and tries to close the GCB to the dead busbar in the Open Transition Mode, but the busbar voltage is NOT below the dead busbar detection limit.
- Check 4: The easYgen tries to synchronize the GCB, the MCB is closed, but the mains is not within its operating range (parameters 5810 [p. 140](#), 5811 [p. 140](#), 5812 [p. 140](#), or 5813 [p. 140](#)).
- Check 5: The easYgen tries to close the GCB, the MCB is closed, but the busbar is dead.

No alarm will be issued in idle mode. This monitoring function is disabled below firing speed.



**NOTICE!**

If load-dependent start/stop (refer to [Chapter 4.5.11.1 "Load Dependent Start Stop \(LDSS\)" on page 281](#)) is enabled, this monitoring function must be configured with a shutdown alarm class (C, D, E, or F) or disable load-dependent start/stop if triggered to ensure that the next engine will be started.



*If this protective function is triggered, the display indicates "Operat. range failed" and the logical command variable "06.31" will be enabled.*

ID	Parameter	CL	Setting range [Default]	Description
2660	Monitoring	2	[On]	Monitoring of the operating range is carried out according to the following parameters.
			Off	Monitoring is disabled.
2663	Delay	2	1 to 999 s [30 s]	If one of the above mentioned conditions for an operating range failure is fulfilled, an alarm will be issued. If the respective condition is not fulfilled anymore before the delay time expires, the delay time will be reset.
2661	Alarm class	2	Class A/B/C/D/E/F, Control [B]	Each limit may be assigned an independent alarm class that specifies what action should be taken when the limit is surpassed.
				<b>Notes</b> For additional information refer to <a href="#">Chapter 9.5.1 "Alarm Classes" on page 733</a>
2662	Self acknowledge	2	Yes	The control unit automatically clears the alarm if the fault condition is no longer detected.
			[No]	The control unit does not automatically reset the alarm when the fault condition is no longer detected.  The alarm must be acknowledged and reset by manually pressing the appropriate buttons or by activating the LogicsManager output "External acknowledgement" (via a discrete input or via an interface).

**4.4.3.11 Engine Charge Alternator (D+)**

**General notes**

The charge alternator monitoring issues an alarm if the voltage measured at the auxiliary excitation input D+ (terminal 65) falls below a fix limit.

The fix limit depends on the power supply voltage. If a power supply voltage exceeding 16 V is detected, the unit assumes a 24 V system and uses a limit of 20 V. If a power supply voltage below 16 V is detected, the unit assumes a 12 V system and uses a limit of 9 V.



*If this protective function is triggered, the display indicates "Charge alt. low volt" and the logical command variable "05.11" will be enabled.*

ID	Parameter	CL	Setting range [Default]	Description
4050	<b>Monitoring</b>	2	On	Monitoring of the charge alternator is carried out according to the following parameters.
			[Off]	Monitoring is disabled.
4055	<b>Delay</b>	2	2 to 999 s [10 s]	If the voltage measured at the auxiliary excitation input D+ falls below a fixed limit for the time defined here, an alarm will be issued.  If the voltage returns within the limit before the delay time expires, the delay time will be reset.
4051	<b>Alarm class</b>	2	Class A/B/C/D/E/F [B]	Each limit may be assigned an independent alarm class that specifies what action should be taken when the limit is surpassed.
				<b>Notes</b>  For additional information refer to <a href="#">Chapter 9.5.1 "Alarm Classes" on page 733</a>
4052	<b>Self acknowledge</b>	2	Yes	The control unit automatically clears the alarm if the fault condition is no longer detected.
			[No]	The control unit does not automatically reset the alarm when the fault condition is no longer detected.  The alarm must be acknowledged and reset by manually pressing the appropriate buttons or by activating the LogicsManager output "External acknowledgement" (via a discrete input or via an interface).
4053	<b>Delayed by engine speed</b>	2	[Yes]	Monitoring for fault conditions is not performed until engine delayed monitoring is enabled. The engine monitoring delay time (parameter 3315 <a href="#">p. 270</a> ) must expire prior to fault monitoring being enabled for parameters assigned this delay.
			No	Monitoring for this fault condition is continuously enabled regardless of engine speed.

### 4.4.3.12 Cylinder Temperature

#### General Notes

package 2 only.



*Up to 20 temperatures monitored!*

Gas engines needs to be monitored for equal exhaust or cylinder head temperatures. If one cylinder temperature deviates too much from the others, something must be wrong. This could be for example a failed spark plug or a too hot combustion.

The easYgen-3000 series provides a monitor which supervises the deviation of a single temperature to the average temperature of a group. Whereby either one average temperature exists (inline engine) or two average temperatures are available (V-engine with two banks).

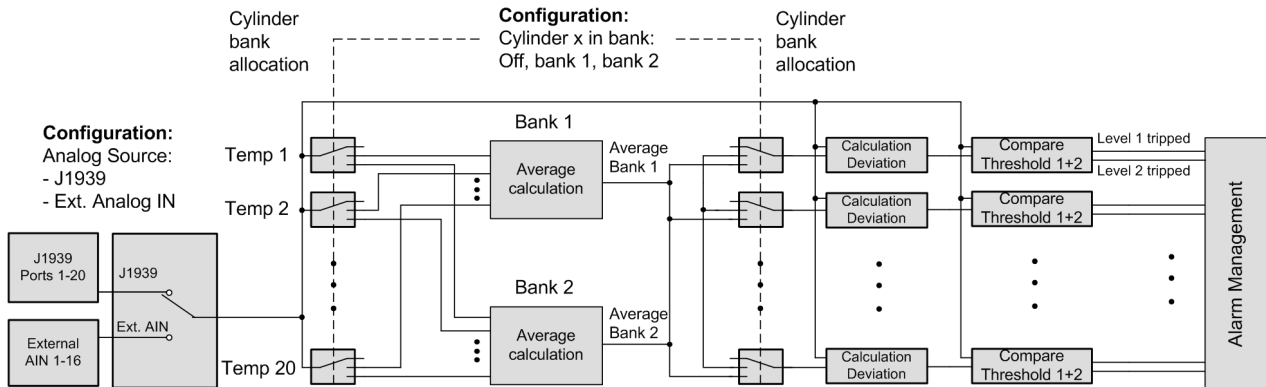

Fig. 83: Cylinder Temperature Monitoring

The monitor is configurable for:

- overrun,
- underrun
- or both.
- Two monitoring levels per temperature measurement.
  - The both levels can be individually activated by different power limits.

**P2:** The temperatures could be provided for package 2 only; either by CAN J1939 (SPN 1137 - 1156, 20 ports) for example *Axiomatic Thermocouple Scanner* (or by External Analog Inputs (AI1 - AI16, 16 ports) for example *Phoenix Temperature Module*).

**Monitoring Function**

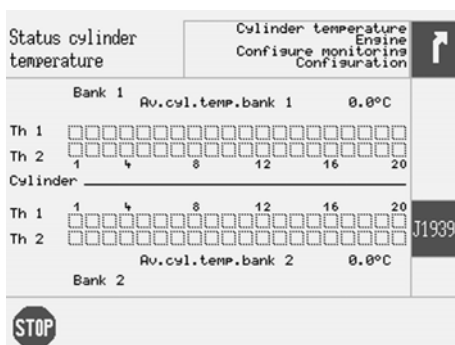

Fig. 84: Status Cylinder Temperature

The monitor compares the single temperature deviations from the average temperature of the according bank. An inline engine has only one group (one bank), so all temperatures are usually allocated to bank 1. A V-engine has two groups (two banks), so the single temperatures are distributed to bank 1 and bank 2. The monitoring mode is valid for all temperatures. The monitoring mode can be 'Off', 'Overrun', 'Underrun' or 'Overrun and Underrun'. The mode is valid for all banks.

The monitoring generally is released by a LogicsManager equation. Each monitoring level (level 1 or 2) can be separately released by a configurable generator power.



*A cylinder with sensor defect is removed from the average temperature calculation and trips an independent alarm!*

**Alarm System / Eventlogger**

The alarm system provides three alarm messages:

## Configuration

Configure Monitoring > Engine > Cylinder Temperature

- Cylinder temperature level 1
- Cylinder temperature level 2
- Wire break

### Command Variables

The easYgen provides LogicsManager command variables:

- 24.71 LM: Release cyl. temp.
- 03.41 Cyl. temp. lev. 1
- 03.42 Cyl. temp. lev. 2
- 03.43 Cyl. temp.wire break

### Analog Variables

The easYgen provides AnalogManager variables::

- 00.17 Average Cyl. Temp. Bank 1
- 00.18 Average Cyl. Temp. Bank 2



- *The hysteresis for the temperature limit is 2°C.*
- *The hysteresis for the power limit is 1% rated generator power.*

### Alarm Screen

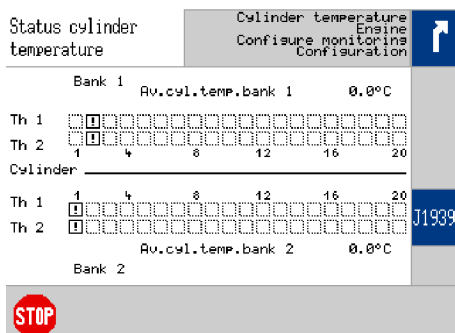

Fig. 85: Cylinder temperature screen

- The square is dotted, if the according cylinder is not configured
- The square contains an arrow-up, if the limit is exceeded
- The square contains an arrow-down, if limit is below target
- The square contains a '!' exclamation point sign, if the sensor is missing (wire break) or error was detected
- If an alarm occurs and the monitor is still active, the new alarm is linked by logic 'OR' to the others
- The monitor ignores values of cylinders with wire break or sensor defect
- The alarm trip displaying is removed, if the alarm of the according level was successful acknowledged
- The wire break trip has a higher priority as the limit monitoring. That means: with up-coming wire break only the according trip bits are RESET. Other cylinders not touched.

### Level 1

ID	Parameter	CL	Setting range [Default]	Description
15158	Release cyl.temp.	2	Determined by LogicsManager [(0 & 1) & 1; t <sub>ON</sub> = 0.00; t <sub>OFF</sub> = 0.00]	True: The temperature deviation monitoring is released. False: The temperature deviation monitoring is blocked.
8876	Monitoring at	2	[Off] Overrun	The monitoring is deactivated. The alarm screen is not displayed. The single temperatures are monitored on maximum deviation in direction of higher temperatures.



ID	Parameter	CL	Setting range [Default]	Description
			Underrun	The single temperatures are monitored on maximum deviation in direction of lower temperatures.
			Both	The single temperatures are monitored on maximum deviation in direction of lower and higher temperatures.
8877	Source cylinder temperature	2	Ext.AIN	The temperatures are taken from external temperature module (Phoenix, AI1 - AI16, 16 ports).
			[J1939]	The temperatures are taken from the J1939 protocol. (SPN 1137 - 1156, 20 ports).
			<b>Notes</b>	Parameter available only if external sources for cylinder temperature are connected.
8878	Minimum generator power	2	000.0 ... 150.0 %	When the generator power exceeds this value the level 1 monitoring is activated.
			[30.0 %]	Respectively the level 1 is deactivated, if the power level is undershoot.
8879	Limit	2	0000 ... 9999° C	Threshold level 1
			[100° C]	
8880	Delay	2	0000 ... 9999 s	Time between *** exceeds limits and *** is activated.
			[60 s]	
8881	Alarm class	2	Class A/B/C/D/E/F, Control	Each limit may be assigned to an independent alarm class that specifies what action should be taken when the limit is surpassed.
			[B]	For additional information refer to. <a href="#">Chapter 9.5.1 "Alarm Classes" on page 733.</a>
8882	Self acknowledge	2	Yes	The control unit automatically clears the alarm if the fault condition is no longer detected.
			[No]	The control unit does not automatically reset the alarm when the fault condition is no longer detected.  The alarm must be acknowledged and reset by manually pressing the appropriate buttons or by activating the LogicsManager output "External acknowledgement" (via a discrete input or via an interface).

## Level 2

ID	Parameter	CL	Setting range [Default]	Description
8883	Minimum generator power	2	000.0 ... 150.0 %	When the generator power exceeds this value the level 2 monitoring is activated.
			[30.0 %]	Respectively the level 2 is deactivated, if the power level is undershoot.
8884	Limit	2	0000 ... 9999° C	Threshold level 2
			[150° C]	
8885	Delay	2	0000 ... 9999 s	Time between *** exceeds limits and *** is activated.
			[60 s]	

## Configuration

Configure Monitoring > Engine > Cylinder Temperature

ID	Parameter	CL	Setting range [Default]	Description
8886	Alarm class	2	Class A/B/C/D/E/F, Control	Each limit may be assigned to an independent alarm class that specifies what action should be taken when the limit is surpassed.
			[B]	For additional information refer to. <a href="#">Chapter 9.5.1 "Alarm Classes" on page 733.</a>
8887	Self acknowledge	2	Yes	The control unit automatically clears the alarm if the fault condition is no longer detected.
			[No]	The control unit does not automatically reset the alarm when the fault condition is no longer detected.  The alarm must be acknowledged and reset by manually pressing the appropriate buttons or by activating the LogicsManager output "External acknowledgement" (via a discrete input or via an interface).

### Wirebreak Cylinder Temperature

ID	Parameter	CL	Setting range [Default]	Description
8890	Delay	2	0000 ... 9999 s	Time between *** exceeds limits and *** is activated.
			[2 s]	
8888	Alarm class	2	Class A/B/C/D/E/F, Control	Each limit may be assigned to an independent alarm class that specifies what action should be taken when the limit is surpassed.
			[B]	For additional information refer to. <a href="#">Chapter 9.5.1 "Alarm Classes" on page 733.</a>
8889	Self acknowledge	2	Yes	The control unit automatically clears the alarm if the fault condition is no longer detected.
			[No]	The control unit does not automatically reset the alarm when the fault condition is no longer detected.  The alarm must be acknowledged and reset by manually pressing the appropriate buttons or by activating the LogicsManager output "External acknowledgement" (via a discrete input or via an interface).
14584	Alarm text	2	[Cyl.tmp.wire brk.]	Text is visible in display during alarm is detected.

Temperature X Bank

ID	Parameter	CL	Setting range [Default]	Description
8856	Bank selct cyl- inder {x}	2	[Off]	The temperature does not exist.
8857			Bank 1	The temperature exists and is located in cylinder bank 1.
8858			Bank 2	The temperature exists and is located in cylinder bank 2.
8859				
8860				
8861				
8862				
8863				
8864				
8865				
8867				
8868				
8869				
8870				
8871				
8872				
8873				
8874				
8875				

Cylinder status

Each cylinder is represented by a 2-bit combination that has the following meanings:

- 00 - OK
- 01 - Overrun
- 10 - Underrun
- 11 - Error/missing

These two bits are carried by parameters ID 3352 ..3354 for the cylinders of bank 1 and ID 3355..3357 for the cylinders of bank 2:

Bank	Cyl- inder	ID	Bits	Bank	Cyl- inder	ID	Bits		
1	1	3352	0..1	2	1	3355	0..1		
	2		2..3		2		2..3		
	...		...		...		...		
	8		14..15		8		14..15		
	9	9	3353		0..1	9	3356	0..1	
		10			2..3			10	2..3
		...			...			...	...
		16			14..15			16	14..15

Bank	Cyl-inder	ID	Bits	Bank	Cyl-inder	ID	Bits
	17	3354	0..1		17	3357	0..1
	18		2..3		18		2..3
	19		4..5		19		4..5
	20		6..7		20		6..7
	(not in use)		8..15		(not in use)		8..15

## 4.4.4 Breaker

### 4.4.4.1 Configure GCB

#### General notes

Circuit breaker monitoring contains two alarms: A "breaker reclose" alarm and a "breaker open" alarm.

#### "Breaker reclose alarm"

If the control initiates a close of the breaker and the breaker fails to close after the configured number of attempts the monitoring CB alarm will be initiated (refer to parameter "GCB maximum closing attempts", parameter 3418 ↗ p. 189).



*If this protective function is triggered, the display indicates "GCB fail to close" and the logical command variable "08.05" will be enabled.*

#### "Breaker open alarm"

If the control is attempting to open the circuit breaker and it fails to see that the CB is open within the configured time in seconds after issuing the breaker open command then the monitoring CB alarm will be initiated (refer to parameter "GCB open monitoring", parameter 3420 ↗ p. 189).



#### NOTICE!

If load-dependent start/stop (refer to ↗ *Chapter 4.5.11.1 "Load Dependent Start Stop (LDSS)" on page 281*) is enabled, this monitoring function must be configured with a shutdown alarm class (C, D, E, or F) or disable load-dependent start/stop if triggered to ensure that the next engine will be started.



*If this protective function is triggered, the display indicates "GCB fail to open" and the logical command variable "08.06" will be enabled.*

ID	Parameter	CL	Setting range [Default]	Description
2600	Monitoring	2	[On]	Monitoring of the GCB is carried out according to the following parameters.
			Off	Monitoring is disabled.
2601	GCB Alarm class	2	Class A/B/C/D/E/F [C]	Each limit may be assigned an independent alarm class that specifies what action should be taken when the limit is surpassed.
				<p><b>Notes</b></p> <p>For additional information refer to <a href="#">Chapter 9.5.1 "Alarm Classes" on page 733</a></p>
3418	GCB maximum closing attempts	2	1 to 10 [5]	<p>The maximum number of breaker closing attempts is configured in this parameter (relay output "Command: close GCB").</p> <p>When the breaker reaches the configured number of attempts, a "GCB fail to close" alarm is issued.</p> <p>The counter for the closure attempts will be reset as soon as the "Reply GCB" is de-energized for at least 5 seconds to signal a closed GCB.</p>
3420	GCB open monitoring	2	0.10 to 5.00 s [2.00 s]	If the "Reply GCB" is not detected as energized once this timer expires, a "GCB fail to open" alarm is issued. This timer initiates as soon as the "open breaker" sequence begins. The alarm configured in parameter 2601 <a href="#">p. 189</a> is issued.

#### 4.4.4.2 Synchronization GCB

##### General notes



**NOTICE!**

If load-dependent start/stop (refer to [Chapter 4.5.11.1 "Load Dependent Start Stop \(LDSS\)" on page 281](#)) is enabled, this monitoring function must be configured with a shutdown alarm class C, D, E, or F) or disable load-dependent start/stop if triggered to ensure that the next engine will be started.

ID	Parameter	CL	Setting range [Default]	Description
3060	Monitoring	2	[On]	Monitoring of the GCB synchronization is carried out according to the following parameters.
			Off	Monitoring is disabled.
3063	Timeout	2	3 to 999 s [60 s]	<p>If it was not possible to synchronize the GCB within the time configured here, an alarm will be issued.</p> <p>The message "GCB syn. timeout" is issued and the logical command variable "08.30" will be enabled.</p>
3061	Alarm class	2	Class A/B/C/D/E/F, Control [B]	Each limit may be assigned an independent alarm class that specifies what action should be taken when the limit is surpassed.

ID	Parameter	CL	Setting range [Default]	Description
				<b>Notes</b> For additional information refer to <a href="#">Chapter 9.5.1 "Alarm Classes" on page 733</a>
3062	Self acknowledge	2	Yes	The control unit automatically clears the alarm if the fault condition is no longer detected.
			[No]	The control unit does not automatically reset the alarm when the fault condition is no longer detected.  The alarm must be acknowledged and reset by manually pressing the appropriate buttons or by activating the LogicsManager output "External acknowledgement" (via a discrete input or via an interface).

4.4.4.3 Configure MCB

General notes



*If an alarm is detected when attempting to close the MCB, an emergency power operation will be carried out if the "Emergency start with MCB failure" is "On".*

*If an alarm class higher than 'B' class has been selected it will not be possible to start the engine with the setting "Emergency start with MCB failure" (parameter 3408 [p. 277](#)) = configured as "On" in an emergency power condition.*



*All parameters listed below only apply to application mode **A04**.*

Circuit breaker monitoring contains two alarms: A breaker reclose alarm and a breaker open alarm.

**"Breaker reclose alarm"**

If the control unit initiates a close of the breaker and the breaker fails to close after the configured number of attempts the monitoring CB alarm will be initiated.

- Refer to parameter "MCB maximum closing attempts", parameter 3419 [p. 192](#).



*If this protective function is triggered, the display indicates "MCB fail to close" and the logical command variable "08.07" will be enabled.*

**"Breaker open alarm"**

If the control unit is attempting to open the circuit breaker and it fails to see that the CB is open within the configured time in seconds after issuing the breaker open command then the monitoring CB alarm will be initiated.

- Refer to parameter "MCB open monitoring", parameter 3421 [p. 192](#).



*If this protective function is triggered, the display indicates "MCB fail to open" and the logical command variable "08.08" will be enabled.*

**Fault at 'closing the MCB'**

Alarm classes A & B

- Parameter 2802 ↪ p. 277 "Emergency run" = Off;  
If the MCB cannot be closed, the busbar remains without voltage, until the MCB breaker fault is acknowledged. The control continues attempting to close the MCB.
- Parameter 2802 ↪ p. 277 "Emergency run" = On, parameter 3408 ↪ p. 277 "Emergency start with MCB failure" = Off;  
If the MCB cannot be closed, the busbar remains without voltage, until the MCB breaker fault is acknowledged. The control continues attempting to close the MCB.
- Parameter 2802 ↪ p. 277 "Emergency run" = On, parameter 3408 ↪ p. 277 "Emergency start with MCB failure" = On;  
If the MCB cannot be closed, an emergency power operation is initiated (the engine is started and the GCB is closed; the busbar is supplied by the generator).  
If the alarm is acknowledged and if the MCB can be closed, the load is switched to mains supply and the emergency power operation terminates.

**Fault at 'opening the MCB'**

This alarm class has the following influence to the function of the unit:

- This fault is processed according to the action described within the alarm classes. As long as the reply is present that the MCB is still closed, the GCB cannot be closed.

ID	Parameter	CL	Setting range [Default]	Description
2620	MCB monitoring	2	[On]	Monitoring of the MCB is carried out according to the following parameters.
			Off	Monitoring is disabled.
2621	MCB Alarm class	2	Class A/B/C/D/E/F [B]	Each limit may be assigned an independent alarm class that specifies what action should be taken when the limit is surpassed.
				<p><b>Notes</b></p> <p>For additional information refer to ↪ Chapter 9.5.1 "Alarm Classes" on page 733</p>

ID	Parameter	CL	Setting range [Default]	Description
3419	<b>MCB maximum closing attempts</b>	2	1 to 10 [5]	<p>The maximum number of breaker closing attempts is configured in this parameter (relay output "Command: close MCB").</p> <p>When the breaker reaches the configured number of attempts, an "MCB fail to close" alarm is issued.</p> <p>The counter for the closure attempts will be reset as soon as the "Reply MCB" is de-energized for at least 5 seconds to signal a closed MCB.</p>
3421	<b>MCB open monitoring</b>	2	0.10 to 5.00 s [2.00 s]	<p>If the "Reply MCB" is not detected as energized once this timer expires, an "MCB fail to open" alarm is issued.</p> <p>This timer initiates as soon as the "open breaker" sequence begins. The alarm configured in parameter 2621 ↗ p. 191 is issued.</p>

#### 4.4.4.4 Synchronization MCB

ID	Parameter	CL	Setting range [Default]	Description
3070	<b>Monitoring</b>	2	[On]	Monitoring of the MCB synchronization is carried out according to the following parameters.
			Off	Monitoring is disabled.
3073	<b>Timeout</b>	2	3 to 999 s [60 s]	<p>If it was not possible to synchronize the MCB within the time configured here, an alarm will be issued.</p> <p>The message "MCB syn. timeout" is issued and the logical command variable "08.31" will be enabled.</p>
3071	<b>Alarm class</b>	2	Class A/B/C/D/E/F, Control [B]	Each limit may be assigned an independent alarm class that specifies what action should be taken when the limit is surpassed.
				<p><b>Notes</b></p> <p>For additional information refer to ↗ <i>Chapter 9.5.1 "Alarm Classes" on page 733</i></p>
3072	<b>Self acknowledge</b>	2	Yes	The control unit automatically clears the alarm if the fault condition is no longer detected.
			[No]	<p>The control unit does not automatically reset the alarm when the fault condition is no longer detected.</p> <p>The alarm must be acknowledged and reset by manually pressing the appropriate buttons or by activating the LogicsManager output "External acknowledgement" (via a discrete input or via an interface).</p>



#### 4.4.4.5 Generator/Busbar/Mains Phase Rotation

##### General notes



##### NOTICE!

##### Damage to the control unit and/or generation equipment

- Ensure that the control unit is properly connected to phase voltages on both sides of the circuit breaker(s) during installation.

Failure to do so may result in damage to the control unit and/or generation equipment due to the breaker closing asynchronously or with mismatched phase rotations. Also ensure that phase rotation monitoring is enabled at all connected components (engine, generator, breakers, cable, busbars, etc.).

This function will block a connection of systems with mismatched phases only under the following conditions:

- The voltages being measured are wired correctly with respect to the phase rotation at the measuring points (i.e. the potential transformers in on both sides of the circuit breaker)
- The voltages being measured are wired so that angular phase shifts or any interruptions from the measuring point to the control unit do not exist
- The voltages being measured are wired to the correct terminals of the control unit (i.e. L1 phase of the generator is connected with the terminal of the control unit which is intended for the generator L1 phase)
- The configured alarm class is of class C, D, E, or F (shutdown alarm).



*All parameters listed below only apply to application mode **A04**.*

Correct phase rotation of the phase voltages ensures that damage will not occur during a breaker closure to either the mains or the generator. The voltage phase rotation alarm checks, if the phase rotation of the measured voltage systems are identical.

If the control detects different phase rotations of mains and generator, the alarm will be initiated and a breaker synchronization is inhibited. However, this alarm will not prevent a dead busbar closure, i.e. a dead bus start.



*If this protective function is triggered, the display indicates "Ph.rotation mismatch" and the logical command variable "08.33" will be enabled.*



*This monitoring function is only enabled if Generator voltage measuring (parameter 1851 ↗ p. 96) and Mains voltage measuring (parameter 1853 ↗ p. 98) are configured to "3Ph 4W" or "3Ph 3W" and the measured voltage exceeds 50 % of the rated voltage (parameter 1766 ↗ p. 95) or if Generator voltage measuring (parameter 1851 ↗ p. 96) and Mains voltage measuring (parameter 1853 ↗ p. 98) are configured to "1Ph 2W". In this case, the phase rotation is not evaluated, but defined by the 1Ph2W phase rotation (parameter 1859 ↗ p. 96).*

ID	Parameter	CL	Setting range [Default]	Description
2940	Monitoring	2	[On]	Phase rotation monitoring is carried out according to the following parameters
			Off	Monitoring is disabled.
2941	Alarm class	2	Class A/B/C/D/E/F, Control [B]	Each limit may be assigned an independent alarm class that specifies what action should be taken when the limit is surpassed.
				<b>Notes</b> For additional information refer to ↗ Chapter 9.5.1 "Alarm Classes" on page 733
2942	Self acknowledge	2	[Yes]	The control unit automatically clears the alarm if the fault condition is no longer detected.
			No	The control unit does not automatically reset the alarm when the fault condition is no longer detected.  The alarm must be acknowledged and reset by manually pressing the appropriate buttons or by activating the LogicsManager output "External acknowledgement" (via a discrete input or via an interface).

### 4.4.5 Flexible Limits

#### General notes



**CAUTION!**

**Hazards due to improper configuration of protective functions**

Flexible Limits must not be used for protective functions, because the monitoring function is not guaranteed beyond an exceeding of 320 %.



*It is not possible to monitor temperature values in Degree Fahrenheit and pressure values in psi. Although parameters 3631 ↗ p. 235 or 3630 ↗ p. 235 are configured to a value display in °F or psi, flexible limit monitoring always refers to the value in Degree Celsius or bar (J1939 protocol: kPa).*

This control unit offers 40 flexible limits. They may be used for "limit switch" functions of all measured analog values. It is possible to choose between alarm (warning and shutdown) and control operation via the LogicsManager.

If an alarm class is triggered, the display indicates "Flexible limit {x}", where {x} indicates the flexible limit 1 to 40, or the text configured using ToolKit and the logical command variable "15.{x}" will be enabled.



*The flexible limits 25 through 32 are configurable additionally with a 'Fallback time' e.g., for load shedding.*



*The flexible limits 33 through 40 are disabled during idle mode operation (refer to [Chapter 4.5.9.4 "Idle Mode"](#) on page 274).*

The following parameter description refers to flexible limit 1. The flexible limits 2 through 40 are configured accordingly. The parameter IDs of the flexible limits 2 through 40 are listed below.

ID	Parameter	CL	Setting range [Default]	Description
4208	Description	2	user-defined [Flex. limit {x}]	A description for the respective flexible limit may be entered here. The description may have 4 through 16 characters and is displayed instead of the default text if this limit is exceeded.
				<b>Notes</b> This parameter may only be configured using ToolKit configuration software.
4200	Monitoring	2	On	Monitoring of the limit {x} is carried out according to the following parameters.
			[Off]	Monitoring is disabled.
4206	Monitored data source	2	data source	Any possible data source may be selected. Refer to <a href="#">Chapter 9.3.1 "Data Sources"</a> on page 671 for a list of all data sources. <b>Examples:</b> <ul style="list-style-type: none"> <li>■ 00.05 Analog input D+</li> <li>■ 01.24 Generator total power</li> <li>■ 02.14 Mains current L1</li> <li>■ 06.01 Analog input 1</li> </ul>
4204	Monitoring at	2	[Overrun]	The monitored value must exceed the threshold limit for a fault to be recognized.
			Underrun	The monitored value must fall below the threshold limit for a fault to be recognized.

## Configuration

### Configure Monitoring > Flexible Limits

ID	Parameter	CL	Setting range [Default]	Description
4205	Limit	2	-32000 to 32000  [100]	<p>The threshold limit of the value to be monitored is defined by this parameter. If this value is reached or exceeded / fallen below (dependent on parameter 4207 ↗ p. 196) for at least the delay time configured in parameter 4207 ↗ p. 196 the action specified by the alarm class is initiated after the configured delay expires.</p> <p>The entry format of the threshold depends on the respective analog value.</p> <p>If the monitored analog value has a reference value, the threshold is expressed as a percentage of this reference value (-320.00 % to 320.00 %). If an analog input is monitored, the threshold refers to the display value format (refer to ↗ Chapter 9.3.2.16 "Display Value Format" on page 688).</p>
				<p><b>Notes</b></p> <p>Refer to ↗ "Examples" on page 198 for examples on how to configure the limit.</p>
4216	Hysteresis	2	0 to 32000  [1]	<p>During monitoring, the actual value must exceed or fall below one of the limits defined in parameter 4205 ↗ p. 196 to be recognized as out of permissible limits. For a value to register as having returned to the permissible limits, the monitored value must rise above or fall below this value for the hysteresis.</p> <p>The format for entering the hysteresis depends on the monitored analog input and corresponds with the one of the threshold listed in parameter 4205 ↗ p. 196.</p>
4207	Delay	2	00.02 to 327.00 s  [1.00 s]	<p>If the monitored value exceeds or falls below the threshold value for the delay time configured here, an alarm will be issued. If the monitored value falls below the threshold (plus/minus the hysteresis, dependent on parameter 4204 ↗ p. 195) before the delay expires the time will be reset.</p>
<i>Beginning: For flexible limit 25 ... 32 only; sample refers to flexible limit #25.</i>				
6646	Fallback time	2	00.02 to 327.00 s  [1.00 s]	<p>If the monitored value exceeds or falls below the threshold value, a counter will start and finally disable the alarm. If the monitored value comes back into the threshold value (plus/minus the hysteresis) before the fallback time expires the time will be reset.</p>
<i>End: For flexible limit 25 ... 32 only; sample referred to flexible limit #25.</i>				
4201	Alarm class	2	Class A/B/C/D/E/F, Control  [B]	<p>Each limit may be assigned an independent alarm class that specifies what action should be taken when the limit is surpassed.</p>
				<p><b>Notes</b></p> <p>For additional information refer to ↗ Chapter 9.5.1 "Alarm Classes" on page 733</p>
4202	Self acknowledge	2	Yes	<p>The control unit automatically clears the alarm if the fault condition is no longer detected.</p>
			[No]	<p>The control unit does not automatically reset the alarm when the fault condition is no longer detected.</p> <p>The alarm must be acknowledged and reset by manually pressing the appropriate buttons or by activating the LogicsManager output "External acknowledgement" (via a discrete input or via an interface).</p>

ID	Parameter	CL	Setting range [Default]	Description
4203	Delayed by engine speed	2	Yes	Monitoring for fault conditions is not performed until engine delayed monitoring is enabled. The engine monitoring delay time (parameter 3315 ↗ p. 270) must expire prior to fault monitoring being enabled for parameters assigned this delay.
			[No]	Monitoring for this fault condition is continuously enabled regardless of engine speed.

Parameter IDs

Flexible limit #	Description	Monitoring	Monitored analog input	Monitoring at	Limit	Hysteresis	Delay	Alarm class	Self acknowledge	Delayed by engine speed
							Fallback			
1	4208	4200	4206	4204	4205	4216	4207	4201	4202	4203
2	4225	4217	4223	4221	4222	4233	4224	4218	4219	4220
3	4242	4234	4240	4238	4239	4250	4241	4235	4236	4237
4	4259	4251	4257	4255	4256	4267	4258	4252	4253	4254
5	7108	4270	4276	4274	4275	4278	4277	4271	4272	4273
6	7116	4280	4286	4284	4285	4288	4287	4281	4282	4283
7	7124	4290	4296	4294	4295	4298	4297	4291	4292	4293
8	7132	6000	6006	6004	6005	6008	6007	6001	6002	6003
9	7140	6010	6016	6014	6015	6018	6017	6011	6012	6013
10	7148	6020	6026	6024	6025	6028	6027	6021	6022	6023
11	7156	6030	6036	6034	6035	6038	6037	6031	6032	6033
12	7164	6040	6046	6044	6045	6048	6047	6041	6042	6043
13	7172	6050	6056	6054	6055	6058	6057	6051	6052	6053
14	7180	6060	6066	6064	6065	6068	6067	6061	6062	6062
15	7188	6070	6076	6074	6075	6078	6077	6071	6072	6073
16	7196	6080	6086	6084	6085	6088	6087	6081	6082	6083
17	7204	6090	6096	6094	6095	6098	6097	6091	6092	6093
18	7212	6100	6106	6104	6105	6108	6107	6101	6102	6103
19	7220	6110	6116	6114	6115	6118	6117	6111	6112	6113
20	7228	6120	6126	6124	6125	6128	6127	6121	6122	6123
21	7236	6130	6136	6134	6135	6138	6137	6131	6132	6133
22	7244	6140	6146	6144	6145	6148	6147	6141	6142	6143
23	7252	6150	6156	6154	6155	6158	6157	6151	6152	6153
24	7260	6160	6166	6164	6165	6168	6167	6161	6162	6163
25	7268	6170	6176	6174	6175	6178	6177 6646	6171	6172	6173
26	7276	6180	6186	6184	6185	6188	6187	6181	6182	6183

## Configuration

Configure Monitoring > Flexible Limits

Flexible limit #	Description	Monitoring	Monitored analog input	Monitoring at	Limit	Hysteresis	Delay	Alarm class	Self acknowledge	Delayed by engine speed
							Fallback			
							6647			
27	7284	6190	6196	6194	6195	6108	6197	6191	6192	6193
							6648			
28	7292	6200	6206	6204	6205	6208	6207	6201	6202	6203
							6649			
29	7300	6210	6216	6214	6215	6218	6217	6211	6212	6213
							6650			
30	7308	6220	6226	6224	6225	6228	6227	6221	6222	6223
							6651			
31	7316	6230	6236	6234	6235	6238	6237	6231	6232	6233
							6652			
32	7324	6240	6246	6244	6245	6248	6247	6241	6242	6243
							6653			
33	7332	6250	6256	6254	6255	6258	6257	6251	6252	6253
34	7340	6260	6266	6264	6265	6268	6267	6261	6262	6263
35	7348	6270	6276	6274	6275	6278	6277	6271	6272	6273
36	7356	6280	6286	6284	6285	6288	6287	6281	6282	6283
37	7364	6290	6296	6294	6295	6298	6297	6291	6292	6293
38	7372	6300	6306	6304	6305	6308	6307	6301	6302	6303
39	7380	6310	6316	6314	6315	6318	6317	6311	6312	6313
40	7388	6320	6326	6324	6325	6328	6327	6321	6322	6323

Table 33: Flexible limits - parameter IDs

## Examples

Example value	Desired limit	Reference value / display value	Limit entry format
01.24 Total generator real power	160 kW	Generator rated real power (parameter 1752 ↪ p. 95) = 200 kW	8000 (= 80.00%)
01.09 Generator frequency	51.5 Hz	Rated frequency (parameter 1750 ↪ p. 95) = 50 Hz	10300 (= 103.00%)
00.01 Engine speed	1256 rpm	Rated speed (parameter 1601 ↪ p. 95) = 1500 rpm	08373 (= 83.73%)
06.03 Analog input 3 (configured to VDO 5 bar)	4.25 bar	Display in 0.01 bar	00425 (= 4.25 bar)

Example value	Desired limit	Reference value / display value	Limit entry format
06.02 Analog input 2 (configured to VDO 150 °C)	123 °C	Display in °C	00123 (= 123 °C)
06.03. Analog input 3 (configured to Linear, Value at 0% = 0, Value at 100% = 1000)	10 mm	Display in 0.000 m (parameter 1035 ↗ p. 241 configured to 0.000 m)	00010 (= 0.010 mm)

Table 34: Flexible limits - analog value examples

The flexible limits must be used to monitor analog inputs like oil pressure or coolant temperature for example. We recommend to change the flexible limit description accordingly.

The table below gives some configuration examples. The analog inputs must be configured accordingly.

Parameter	Example for low oil pressure monitoring	Example for high coolant temperature monitoring
Description	Oil pressure	Coolant temp.
Monitoring	On	On
Monitored data source	06.01 Analog input 1	06.02 Analog input 2
Monitoring at	Underrun	Overrun
Limit	200 (2.00 bar)	80 (80 °C)
Hysteresis	10	2
Delay	0.50 s	3 s
Alarm class	F	B
Self acknowledgment	No	No
Delayed by engine speed	Yes	No

Table 35: Flexible limits - configuration examples

## 4.4.6 Miscellaneous

### 4.4.6.1 Alarm Acknowledgement

ID	Parameter	CL	Setting range [Default]	Description
1756	Time until horn reset	0	0 to 1,000 s [180 s]	After each alarm of alarm class B through F occurs, the alarm LED flashes and the horn (command variable 03.05) is enabled. After the delay time "time until horn reset" has expired, the horn (command variable 03.05) is disabled. The alarm LED flashes until the alarm has been acknowledged either via the push button, the LogicsManager, or the interface.
				<b>Notes</b> If this parameter is configured to 0, the horn will remain active until it will be acknowledged.

ID	Parameter	CL	Setting range [Default]	Description
12490	<b>Ext. acknowledge</b>  (External acknowledgment of alarms)	2	Determined by LogicsManager	<p>It is possible to acknowledge all alarms simultaneously from remote, e.g. with a discrete input. The logical output of the LogicsManager has to become TRUE twice.</p> <p>The first time is for acknowledging the horn, the second for all alarm messages. The On-delay time is the minimum time the input signals have to be "1". The Off-delay time is the time how long the input conditions have to be "0" before the next high signal is accepted.</p> <p>Once the conditions of the LogicsManager have been fulfilled the alarms will be acknowledged.</p> <p>The first high signal into the discrete input acknowledges the command variable 03.05 (horn).</p> <p>The second high signal acknowledges all inactive alarm messages.</p>
				<p><b>Notes</b></p> <p>For information on the LogicsManager and its default settings see ↗ <i>Chapter 9.4.1 "LogicsManager Overview" on page 689.</i></p>
1849	<b>Stop mode with stopping alarm</b>	2	If operating mode is not fixed via LogicsManager (see chapter ↗ <i>Chapter 6.4.5.1 "Operating Modes" on page 437</i> for details) with this parameter it can be decided if the operation mode changes to STOP mode when a shutdown alarm of class C,D,E,F occurs.	
			No	<p>A shut down alarm does not cause an operating mode change.</p> <p>This can be useful in applications with remote control, where the operator wants to acknowledge alarms and restart the engine without the need to change operating mode in the easYgen.</p>
			<b>[Yes]</b>	<p>Each shut down alarm (class C, D, E, F) will change operating mode to STOP.</p>
				<p><b>Notes</b></p> <p>LM 12510 ↗ p. 280, 12520 ↗ p. 280, 12530 ↗ p. 280 do have priority.</p>

#### 4.4.6.2 Free Configurable Alarms

##### General Notes

The easYgen provides four freely configurable alarms.

Each alarm is configurable by:

- Alarm On/Off
- Internal Flag (up to 16 LogicsManager flags available)
- Alarm text (configurable with Toolkit only)
- Delay time
- Alarm class
- Self acknowledgment
- Delayed according to engine speed



Free Alarm 1 to 4

ID	Parameter	CL	Setting range [Default]	Description	
5160	<b>Monitoring</b>	2	ON, OFF	The alarm is enabled.	
5166			[OFF]	The alarm is disabled.	
5172					
5178					
6684	<b>Monitoring source</b>	2	LogicsManager Flag {1 ... 16}	Select source of monitoring via LogicsManager.	
6685					
6686			[LM Flag 1]		
6687					
5164	<b>Delay</b>	2	0.3 ... 999.9 s	Period before alarm becomes TRUE.	
5170			[005.0 s]		
5176					
5182					
5161	<b>Alarm class</b>	2	Class A/B/C/D/E/F/, Control	The assigned independent alarm class specifies what action should be taken when the alarm becomes TRUE.	
5167					
5173			[B]		
5179					
5162	<b>Self acknowledge</b>	2	Yes/No	The control automatically clears the alarm if the fault condition is no longer detected.	
5168					
5174			[No]	The control does not automatically clears the alarm if the fault condition is no longer detected. The alarm must be acknowledged and reset by manually pressing the appropriate buttons or by activating the LogicsManager output "External acknowledgment" (via a discrete input or via an interface).	
5180					
5163	<b>Delayed by engine speed</b>	2	Yes/No	Monitoring for fault conditions is not performed until engine delayed monitoring is enabled. The engine monitoring delay time (parameter 3315 ↗ p. 270) must expire prior to fault monitoring being enabled for parameters assigned this delay.	
5169					
5175					
5181			[No]	Monitoring for this fault condition is continuously enabled regardless of engine speed.	
6680	<b>Free alarm text</b>	2	max. 30* characters	Text is configurable by ToolKit.	
6681					
6682			[((empty))]	<b>Notes</b>	
6683				*) The max. number of characters is 48 but 30 characters can be read on easYgen HMI without restrictions.	

4.4.6.3 CAN Bus Overload

General notes

The CAN busses are monitored. If the sum of CAN bus messages on all CAN buses together exceeds 32 per 20 ms, an alarm will be initiated.



*If this protective function is triggered, the display indicates "CAN bus overload" and the logical command variable "08.20" will be enabled.*

ID	Parameter	CL	Setting range [Default]	Description
3145	Monitoring	2	[On]	CAN bus overload monitoring is carried out according to the following parameters.
			Off	Monitoring is disabled.
3148	Delay	2	0.01 to 650.00 s [5.00]	If more than 32 CAN bus messages per 20 ms are sent on the CAN bus within this time, the action specified by the alarm class is initiated.
3146	Alarm class	2	Class A/B/C/D/E/F/Control [B]	Each limit may be assigned an independent alarm class that specifies what action should be taken when the limit is surpassed.
				<b>Notes</b> Refer to <a href="#">Chapter 9.5.1 "Alarm Classes"</a> on page 733
3147	Self acknowledge	2	Yes	The control automatically clears the alarm if the fault condition is no longer detected.
			[No]	The control does not automatically reset the alarm when the fault condition is no longer detected. The alarm must be acknowledged and reset by manually pressing the appropriate buttons or by activating the LogicsManager output "External acknowledgement" (via a discrete input or via an interface).

#### 4.4.6.4 CAN Interface 1

##### General notes

The CANopen interface 1 is monitored. If the interface does not receive a Receive Process Data Object (RPDO) before the delay expires, an alarm will be initiated.



*If this protective function is triggered, the display indicates "CANopen interface 1" and the logical command variable "08.18" will be enabled.*

ID	Parameter	CL	Setting range [Default]	Description
3150	Monitoring	2	On	CANopen interface 1 monitoring is carried out according to the following parameters.
			[Off]	Monitoring is disabled.
3154	Delay	2	0.01 to 650.00 s [0.20 s]	The maximum receiving break is configured with this parameter.  If the interface does not receive an RPDO within this time, the action specified by the alarm class is initiated. The delay timer is re-initialized after every message is received.

ID	Parameter	CL	Setting range [Default]	Description
3151	Alarm class	2	Class A/B/C/D/E/F/ Control  [B]	Each limit may be assigned an independent alarm class that specifies what action should be taken when the limit is surpassed.
				<b>Notes</b> For additional information refer to <a href="#">Chapter 9.5.1 "Alarm Classes"</a> on page 733
3152	Self acknowl- edge	2	[Yes]	The control unit automatically clears the alarm if the fault condition is no longer detected.
			No	The control unit does not automatically reset the alarm when the fault condition is no longer detected.  The alarm must be acknowledged and reset by manually pressing the appropriate buttons or by activating the LogicsManager output "External acknowledgement" (via a discrete input or via an interface).
3153	Delayed by engine speed	2	Yes	Monitoring for fault conditions is not performed until engine delayed monitoring is enabled. The engine monitoring delay time (parameter 3315 <a href="#">p. 270</a> ) must expire prior to fault monitoring being enabled for parameters assigned this delay.
			[No]	Monitoring for this fault condition is continuously enabled regardless of engine speed.

#### 4.4.6.5 CAN Interface 2

##### General notes

The CANopen interface 2 is monitored. If the interface does not receive a message from the external expansion board (Node-ID) before the delay expires, an alarm will be initiated.



*If this protective function is triggered, the display indicates "CANopen interface 2" and the logical command variable "08.19" will be enabled.*



*If you are not using the exact amount of external I/O modules you have defined, the monitoring function does not work correctly.*

ID	Parameter	CL	Setting range [Default]	Description
16187	Monitoring	2	On	CANopen interface 2 monitoring is carried out according to the following parameters.
			[Off]	Monitoring is disabled.
16186	Delay	2	0.01 to 650.00 s  [0.20 s]	The maximum receiving break is configured with this parameter.  If the interface does not receive message from the external expansion board (Node-ID) within this time, the action specified by the alarm class is initiated. The delay timer is re-initialized after every message is received.

ID	Parameter	CL	Setting range [Default]	Description
16188	Alarm class	2	Class A/B/C/D/E/F/ Control  [B]	Each limit may be assigned an independent alarm class that specifies what action should be taken when the limit is surpassed.
				<b>Notes</b> For additional information refer to <a href="#">Chapter 9.5.1 "Alarm Classes"</a> on page 733
16190	Self acknowledge	2	[Yes]	The control unit automatically clears the alarm if the fault condition is no longer detected.
			No	The control unit does not automatically reset the alarm when the fault condition is no longer detected.  The alarm must be acknowledged and reset by manually pressing the appropriate buttons or by activating the LogicsManager output "External acknowledgement" (via a discrete input or via an interface).
16189	Delayed by engine speed	2	Yes	Monitoring for fault conditions is not performed until engine delayed monitoring is enabled. The engine monitoring delay time (parameter 3315 <a href="#">p. 270</a> ) must expire prior to fault monitoring being enabled for parameters assigned this delay.
			[No]	Monitoring for this fault condition is continuously enabled regardless of engine speed.

#### 4.4.6.6 CAN Interface 2 - J1939 Interface

##### General notes

This watchdog triggers if the easYgen is configured to receive J1939 data from an ECU (parameter 15102 [p. 364](#)) connected to the CAN bus to evaluate this data, and no data is received from the ECU.



*If this protective function is triggered, the display indicates "CAN fault J1939" and the logical command variable "08.10" will be enabled.*

ID	Parameter	CL	Setting range [Default]	Description
15110	Monitoring	2	On	Monitoring of the J1939 interface is carried out according to the following parameters.
			[Off]	Monitoring is disabled.
15114	Delay	2	2 to 6500 s [10 s]	The delay is configured with this parameter. If the interface does not receive a CAN SAE J1939 protocol message before the delay expires, the action specified by the alarm class is initiated.  The delay timer is re-initialized after every message is received.
15111	Alarm class	2	Class A/B/C/D/E/F/ Control  [B]	Each limit may be assigned an independent alarm class that specifies what action should be taken when the limit is surpassed.

ID	Parameter	CL	Setting range [Default]	Description
				<b>Notes</b> For additional information refer to ↪ <i>Chapter 9.5.1 "Alarm Classes" on page 733</i>
15112	<b>Self acknowledge</b>	2	[Yes]	The control unit automatically clears the alarm if the fault condition is no longer detected.
			No	The control unit does not automatically reset the alarm when the fault condition is no longer detected.  The alarm must be acknowledged and reset by manually pressing the appropriate buttons or by activating the LogicsManager output "External acknowledgement" (via a discrete input or via an interface).
15113	<b>Delayed by engine speed</b>	2	Yes	Monitoring for fault conditions is not performed until engine delayed monitoring is enabled. The engine monitoring delay time (parameter 3315 ↪ p. 270) must expire prior to fault monitoring being enabled for parameters assigned this delay.
			[No]	Monitoring for this fault condition is continuously enabled regardless of engine speed.

#### 4.4.6.7 J1939 Interface - Red Stop Alarm

##### General notes

This watchdogs monitors, whether a specific alarm bit is received from the CAN J1939 interface. This enables to configure the easYgen in a way that a reaction is caused by this bit (e.g. warning, shutdown).



*If this protective function is triggered, the display indicates "Red stop lamp" and the logical command variable "05.13" will be enabled.*

ID	Parameter	CL	Setting range [Default]	Description
15115	<b>Monitoring</b>	2	On	Monitoring of the Red Stop Lamp message from the ECU is carried out according to the following parameters.
			[Off]	Monitoring is disabled.
15119	<b>Delay</b>	2	0 to 999 s [2 s]	The red stop lamp delay is configured with this parameter.  If the ECU sends the Red Stop Lamp On message, the action specified by the alarm class is initiated after the delay configured here expires.
15116	<b>Alarm class</b>	2	Class A/B/C/D/E/F/Control [A]	Each limit may be assigned an independent alarm class that specifies what action should be taken when the limit is surpassed.
				<b>Notes</b> For additional information refer to ↪ <i>Chapter 9.5.1 "Alarm Classes" on page 733</i>

ID	Parameter	CL	Setting range [Default]	Description
15117	Self acknowledge	2	[Yes]	The control unit automatically clears the alarm if the fault condition is no longer detected.
			No	The control unit does not automatically reset the alarm when the fault condition is no longer detected.  The alarm must be acknowledged and reset by manually pressing the appropriate buttons or by activating the LogicsManager output "External acknowledgement" (via a discrete input or via an interface).
15118	Delayed by engine speed	2	Yes	Monitoring for fault conditions is not performed until engine delayed monitoring is enabled. The engine monitoring delay time (parameter 3315 ↗ p. 270) must expire prior to fault monitoring being enabled for parameters assigned this delay.
			[No]	Monitoring for this fault condition is continuously enabled regardless of engine speed.

4.4.6.8 J1939 Interface - Amber Warning Alarm

General notes

This watchdogs monitors, whether a specific alarm bit is received from the CAN J1939 interface. This enables to configure the easYgen in a way that a reaction is caused by this bit (e.g. warning, shutdown).



*If this protective function is triggered, the display indicates "Amber warning lamp" and the logical command variable "05.14" will be enabled.*

ID	Parameter	CL	Setting range [Default]	Description
15120	Monitoring	2	On	Monitoring of the Amber Warning Lamp message from the ECU is carried out according to the following parameters.
			[Off]	Monitoring is disabled.
15124	Delay	2	0 to 999 s [2 s]	The amber warning lamp delay is configured with this parameter.  If the ECU sends the Amber Warning Lamp On message, the action specified by the alarm class is initiated after the delay configured here expires.
15121	Alarm class	2	Class A/B/C/D/E/F/Control [A]	Each limit may be assigned an independent alarm class that specifies what action should be taken when the limit is surpassed.
				<b>Notes</b>  For additional information refer to ↗ Chapter 9.5.1 "Alarm Classes" on page 733
15122	Self acknowledge	2	[Yes]	The control unit automatically clears the alarm if the fault condition is no longer detected.

ID	Parameter	CL	Setting range [Default]	Description
			No	The control unit does not automatically reset the alarm when the fault condition is no longer detected.  The alarm must be acknowledged and reset by manually pressing the appropriate buttons or by activating the LogicsManager output "External acknowledgement" (via a discrete input or via an interface).
15123	Delayed by engine speed	2	Yes	Monitoring for fault conditions is not performed until engine delayed monitoring is enabled. The engine monitoring delay time (parameter 3315 ↗ p. 270) must expire prior to fault monitoring being enabled for parameters assigned this delay.
			[No]	Monitoring for this fault condition is continuously enabled regardless of engine speed.

#### 4.4.6.9 Battery Overvoltage (Level 1 & 2)

##### General notes

There are two battery overvoltage alarm levels available in the control. Both alarms are definite time alarms and. Monitoring of the voltage is done in two steps.



*If this protective function is triggered, the display indicates "Bat. overvoltage 1" or "Bat. overvoltage 2" and the logical command variable "08.01" or "08.02" will be enabled.*

Refer to ↗ Chapter 9.1.1 "Triggering Characteristics" on page 551 for the triggering characteristic of this monitoring function.

ID	Parameter	CL	Setting range [Default]	Description
3450 3456	Monitoring	2	3450: [On] 3456: [Off]  (Hysteresis: 0.1 V)  (Reset Delay: 1s)	Overvoltage monitoring of the battery voltage is carried out according to the following parameters. Both values may be configured independent from each other (prerequisite: Level 1 > Level 2).  Monitoring is disabled for Level 1 limit and/or Level 2 limit.
3454 3460			Limit	2
3455 3461	Delay	2		

ID	Parameter	CL	Setting range [Default]	Description
3451 3457	Alarm class	2	Class A/B/C/D/E/F, Control  [B]	Each limit may be assigned an independent alarm class that specifies what action should be taken when the limit is surpassed.
			<b>Notes</b> For additional information refer to <a href="#">Chapter 9.5.1 "Alarm Classes" on page 733</a>	
3452 3458	Self acknowledge	2	Yes	The control unit automatically clears the alarm if the fault condition is no longer detected.
			[No]	The control unit does not automatically reset the alarm when the fault condition is no longer detected.  The alarm must be acknowledged and reset by manually pressing the appropriate buttons or by activating the LogicsManager output "External acknowledgement" (via a discrete input or via an interface).
3453 3459	Delayed by engine speed	2	Yes	Monitoring for fault conditions is not performed until engine delayed monitoring is enabled. The engine monitoring delay time (parameter 3315 <a href="#">p. 270</a> ) must expire prior to fault monitoring being enabled for parameters assigned this delay.
			[No]	Monitoring for this fault condition is continuously enabled regardless of engine speed.

#### 4.4.6.10 Battery Undervoltage (Level 1 & 2)

##### General notes

There are two battery undervoltage alarm levels available in the control. Both alarms are definite time alarms. Monitoring of the voltage is done in two steps.



*If this protective function is triggered, the display indicates "Bat. undervoltage 1" or "Bat. undervoltage 2" and the logical command variable "08.03" or "08.04" will be enabled.*

Refer to [Chapter 9.1.1 "Triggering Characteristics" on page 551](#) for the triggering characteristic of this monitoring function.

ID	Parameter	CL	Setting range [Default]	Description
3500 3506	Monitoring	2	[On]	Undervoltage monitoring of the battery voltage is carried out according to the following parameters. Both values may be configured independent from each other (prerequisite: Level 1 > Level 2).
			Off	Monitoring is disabled for Level 1 limit and/or Level 2 limit.
3504 3510	Limit	2	8.0 to 42.0 V	The threshold values that are to be monitored are defined here.
			3504: [24.0 V] 3510: [20.0 V] (Hysteresis: 0.1 V)	If the monitored battery voltage reaches or falls below this value for at least the delay time without interruption, the action specified by the alarm class is initiated.



ID	Parameter	CL	Setting range [Default]	Description
			(Reset Delay: 1s)	<p><b>Notes</b></p> <p>The default monitoring limit for battery undervoltage is 24 Vdc after 60 seconds.</p> <p>This is because in normal operation the terminal voltage is approximately 26 Vdc (alternator charged battery).</p>
3505 3511	<b>Delay</b>	2	0.02 to 99.99 s 3505: <b>[60.00 s]</b> 3511: <b>[10.00 s]</b>	<p>If the battery voltage falls below the threshold value for the delay time configured here, an alarm will be issued.</p> <p><b>Notes</b></p> <p>If the battery voltage exceeds the threshold (plus the hysteresis) again before the delay expires the time will be reset.</p>
3501 3507	<b>Alarm class</b>	2	Class A/B/C/D/E/F, Control <b>[B]</b>	<p>Each limit may be assigned an independent alarm class that specifies what action should be taken when the limit is surpassed.</p> <p><b>Notes</b></p> <p>For additional information refer to ↪ <i>Chapter 9.5.1 "Alarm Classes" on page 733</i></p>
3502 3508	<b>Self acknowledge</b>	2	Yes <b>[No]</b>	<p>The control unit automatically clears the alarm if the fault condition is no longer detected.</p> <p>The control unit does not automatically reset the alarm when the fault condition is no longer detected.</p> <p>The alarm must be acknowledged and reset by manually pressing the appropriate buttons or by activating the LogicsManager output "External acknowledgement" (via a discrete input or via an interface).</p>
3503 3509	<b>Delayed by engine speed</b>	2	Yes <b>[No]</b>	<p>Monitoring for fault conditions is not performed until engine delayed monitoring is enabled. The engine monitoring delay time (parameter 3315 ↪ p. 270) must expire prior to fault monitoring being enabled for parameters assigned this delay.</p> <p>Monitoring for this fault condition is continuously enabled regardless of engine speed.</p>

#### 4.4.6.11 Multi-Unit Parameter Alignment

##### General notes

The multi-unit parameter alignment functionality requires that the relevant parameters are all configured identically at all participating units.



*If at least one of these parameters is configured different in at least one of the units, the display indicates "Parameter alignment" on all units and the logical command variable "08.16" will be enabled. To identify different configured units, please use the diagnostic screen "Genset bad parameter alignment".*

This alarm is always self-acknowledging, i.e. the control automatically clears the alarm if it is no longer valid.

The setting of the following parameters will be monitored:

Parameter	ID
Start stop mode	5752 ↗ p. 285
Fit size of engine	5754 ↗ p. 286
Fit service hours	5755 ↗ p. 286
Changes of engines	5756 ↗ p. 286
IOP Reserve power	5760 ↗ p. 288
IOP Hysteresis	5761 ↗ p. 288
IOP Max. generator load	5762 ↗ p. 288
IOP Min. generator load	5763 ↗ p. 288
IOP Dynamic	5757 ↗ p. 289
IOP Add on delay	5764 ↗ p. 291
IOP Add on delay at rated load	5765 ↗ p. 291
IOP Add off delay	5766 ↗ p. 291
MOP Minimum load	5767 ↗ p. 291
MOP Reserve power	5768 ↗ p. 292
MOP Hysteresis	5769 ↗ p. 292
MOP Max. generator load	5770 ↗ p. 292
MOP Min. generator load	5771 ↗ p. 292
MOP Dynamic	5758 ↗ p. 293
MOP Add on delay	5772 ↗ p. 294
MOP Add on delay at rated load	5773 ↗ p. 294
MOP Add off delay	5774 ↗ p. 294
Transfer rate LS fast message	9921 ↗ p. 369

Table 36: Multi-unit parameter alignment - monitored parameters

ID	Parameter	CL	Setting range [Default]	Description
4070	<b>Monitoring</b>	2	<b>[On]</b>	Multi-unit parameter alignment monitoring is carried out.
			Off	Monitoring is disabled.
4071	<b>Alarm class</b>	2	Alarm class Class A/B/C/D/E/F, Control  <b>[B]</b>	This function may be assigned an independent alarm class that specifies what action should be taken when this function triggers an alarm.
				<b>Notes</b>  For additional information refer to ↗ Chapter 9.5.1 "Alarm Classes" on page 733.

### 4.4.6.12 Multi-Unit Missing Members

#### General notes

The multi-unit missing members monitoring function checks whether all participating units are available (sending data on the load share line).

If the number of available units is less than the number of members configured in parameter 4063 ↗ p. 211 for at least the delay time, the display indicates "Missing members" and the logical command variable "08.17" will be enabled.



*After energizing the easYgen, a delay is started, which allows a possible "Missing members" alarm to become active. This delay depends on the Node-ID of the easYgen (parameter 8950 ↗ p. 353) and the transfer rate of a load share fast message (parameter 9921 ↗ p. 369) and may last for approx. 140 seconds for a high Node-ID (e.g. 127). This delay serves for detecting the Master of a CAN bus connection. Approximately two minutes after energizing the easYgen, the alarm delay will be set to a fix time, which depends on the setting of parameter 9921 ↗ p. 369 (Transfer rate LS fast message) and is in the range between 3 to 12 seconds.*

ID	Parameter	CL	Setting range [Default]	Description
4060	Monitoring	2	On	Multi-unit missing members monitoring is carried out.
			[Off]	Monitoring is disabled.
4063	Number of gens communicating	2	1 to 32 [1]	The number of units participating in load sharing is configured here.
4061	Alarm class	2	Class A/B/C/D/E/F, Control [B]	This function may be assigned an independent alarm class that specifies what action should be taken when this function triggers an alarm.
				<b>Notes</b> For additional information refer to ↗ Chapter 9.5.1 "Alarm Classes" on page 733.
4062	Self acknowledge	2	Yes	The control automatically clears the alarm if the fault condition is no longer detected.
			[No]	The control does not automatically reset the alarm when the fault condition is no longer detected. The alarm must be acknowledged and reset by manually pressing the appropriate buttons or by activating the LogicsManager output "External acknowledgement" (via a discrete input or via an interface).

### 4.4.6.13 Neutral Interlocking

#### General notes

The monitoring of the Neutral Connector (NC) feedback" Neutral contactor reply mismatch" 08.37 is performed always, if the Neutral Interlocking (parameter 1840 ↗ p. 234) is enabled. The monitor checks, if the feedback behaves according to the NC command. With a configurable delay time, the alarm is activated with a general alarm text. Open failure or closure failure are not differentiated.

Please refer to ↗ *Chapter 6.4.16 "Neutral Interlocking" on page 473* for more details.

ID	Parameter	CL	Setting range [Default]	Description
5149	Alarm class	2	Class A/B/C/D/E/F/ CONTROL  [B]	This function may be assigned an independent alarm class that specifies what action should be taken when this function triggers an alarm.  <b>Notes</b> For additional information refer to ↗ <i>Chapter 9.5.1 "Alarm Classes" on page 733.</i>
5152	Delay	2	0.10 ... 5.00 s  [2]	Period of continuous failure signal before tripping a failure.
5150	Self acknowledge	2	Yes, No  [No]	The control automatically clears the alarm if the fault condition is no longer detected.
5153	Alarm text	-	[N-cont. reply mism.]	Text is visible in display during alarm is detected.

## 4.5 Configure Application

### 4.5.1 Configure Breakers

#### General notes



*The assignment of the defined relays to defined functions occurs by selection of the application mode (i.e. function "Command: Close GCB" on relay [R 6], this relay can no longer be operated via the Logics-Manager).*

*The same way some relays are designated to specific functions, others may be assigned to different functions. These are listed as "programmed" relays. If a relay is "programmable" the function may be assigned to other relays via the LogicsManager by configuration.*

*For additional information refer to ↗ Chapter 4.5.5 "Discrete Outputs (LogicsManager)" on page 251.*



*If the easYgen is intended to be operated in parallel with the mains, the mains voltage measuring inputs must be connected. If an external mains decoupling is performed, jumpers between busbar and mains voltage measuring inputs may be installed.*



*Changing the application mode will not change other configured values in the parameters. The application mode parameter is the only one.*

### Operation of the circuit breakers

The configuration of pulse switching takes place in the following screen and has the described effect on the signal sequence (the MCB cannot be controlled by the continuous pulse for security reasons, because otherwise, the MCB would be opened in case of a failure/exchange of the easYgen).

The parameter "Enable MCB" allows/prevents the closing of the MCB. A closed MCB will not be opened.

If the parameter "Auto unlock" is configured to YES, an open pulse will be issued prior to each close pulse.

### External breaker handling

In operation mode AUTO the easYgen operates its breakers automatically according to the configured application and transition modes. Actually the breaker transition mode "external" would only allow the breaker closure from external. On the other hand the easYgen allows in special cases the closure of breaker from external, when the following configurations and modes are fulfilled:

External Breaker Handling	Synchronization Mode	Dead Bus Closure	Condition for the closure acceptance
GCB Synchronization	Off	-	<ul style="list-style-type: none"> <li>■ The start request in automatic is active</li> <li>■ The generator is in operating range</li> <li>■ The engine start procedure is expired</li> </ul>
GCB Dead bus closure	-	Off	
MCB Synchronization	Off	-	The mains is in operating range
GCB Dead bus closure	-	Off	
GGB Synchronization	Off	-	Minimum 1 GCB is closed
GGB Dead bus closure	-	Off	

#### 4.5.1.1 Dead Bus Closing GCB



*The following applies to application modes **A03** and **A04**.*

The unit closes the GCB without synchronization, if the following conditions are met. The display indicates "GCB dead bus cls".

### Automatic operation

- The operating mode AUTOMATIC has been selected
- No class C alarm or higher is present
- The engine is running
- The engine delayed monitoring (parameter 3315 ↗ p. 270) as well as the generator stable time (parameter 3415 ↗ p. 227) have been expired or the LogicsManager function "Undelay close GCB" (parameter 12210 ↗ p. 228) is enabled
- The generator voltage and frequency are within the configured operating range ( ↗ Chapter 4.4.1.1 "Generator Operating Voltage / Frequency" on page 110)
- The MCB has been opened for at least the time configured in "Transfer time GCB↔MCB" (parameter 3400 ↗ p. 224) (Mode A04 with open transition mode only)
- The function "Start without load" (parameter 12540 ↗ p. 279) has been disabled through the LogicsManager
- Only in critical mode: the parameter "Close GCB in override" (parameter 4100 ↗ p. 300) is configured to "Yes"
- The busbar voltage is below the dead bus detection limit (parameter 5820 ↗ p. 224)
- There is no other GCB closed in the same segment
- There is no other device with a smaller device ID willing to close its GCB too (Dead busbar closure negotiation)

### Manual operation

- The operating mode MANUAL has been selected.
- No class C alarm or higher is present.
- The engine is running.
- The engine delayed monitoring (parameter 3315 ↗ p. 270) as well as the generator stable time (parameter 3415 ↗ p. 227) have been expired.
- The generator voltage and frequency are within the configured operating range ( ↗ Chapter 4.4.1.1 "Generator Operating Voltage / Frequency" on page 110).
- The button "Close GCB" has been pressed.
- The MCB has been open for at least the time configured in "Transfer time GCB↔MCB" (parameter 3400 ↗ p. 224). (Mode A04 with open transition mode only)
- The busbar voltage is below the dead bus detection limit (parameter 5820 ↗ p. 224).
- There is no other GCB closed in the same segment.
- There is no other device with a smaller device ID willing to close its GCB too (Dead busbar closure negotiation).

## Dead Busbar Negotiation

Each easYgen, who intends to close its GCB on a dead busbar publishes a "Dead busbar closure request" flag over CANbus and reads back whether there is any other easYgen publishing the same intension:

**If not**, the unit waits an estimated time for security and then closes its breaker.

**If yes**, the unit compares its own device number with the smallest device number of all others who also intend to close. If the own device number is smaller than the rest, the unit will close its breaker - otherwise it blocks its own closure.

The easYgen removes its wish to close its GCB on a dead busbar, if the GCB closure failure occurs in a multiple generator application. So the next easYgen with the higher device number gets the permission for closure.

The load sharing messages are monitored. In case of a “missing member” alarm on the load share bus, the single dead bus closures are delayed depending on the own Generator number to avoid simultaneous closure. The delay time is Generator Number multiplied with 500 ms.

The GCB dead busbar closure is realized faster, if LogicsManager "Undelayed close GCB" ID 12210 is set to TRUE.

The dead busbar negotiation is going over segments.

#### 4.5.1.2 Synchronization GCB/MCB



The following applies to application modes **A03** and **A04**.

The synchronization is active, if the following conditions are met simultaneously.

The display indicates "Synchronization GCB" or "Synchronization MCB".

##### Automatic operation

- The operating mode AUTOMATIC has been selected
- The mains voltage is available and within the configured operating range ( ↪ *Chapter 4.4.2.1 "Mains Operating Voltage / Frequency" on page 139*)
- The generator and busbar voltage are available and within the configured operating range ( ↪ *Chapter 4.4.1.1 "Generator Operating Voltage / Frequency" on page 110*)
- The differential frequency/voltage is within the configured operating range
- Synchronizing the MCB
  - The GCB is closed (or at least one GCB is closed in a multiple genset application)
  - The busbar voltage is within the configured operating range
  - The "Enable MCB" (parameter 12923 ↪ p. 231) signal is present, for example discrete input 6 is energized if configured as DI 6
- Synchronizing the GCB
  - The MCB is closed
  - The busbar voltage is within the configured operating range
  - Engine delayed monitoring (parameter 3315 ↪ p. 270) and generator stable time (parameter 3415 ↪ p. 227) have expired or "Undelay close GCB" (parameter 12210 ↪ p. 228) is enabled

##### Manual operation

- Operating mode MANUAL has been selected
- The mains voltage is available and within the configured operating range ( ↪ *Chapter 4.4.2.1 "Mains Operating Voltage / Frequency" on page 139*)

- The generator and busbar voltage is available and within the configured operating range ( ↪ *Chapter 4.4.1.1 "Generator Operating Voltage / Frequency" on page 110*)
- The differential frequency/voltage is within the configured operating range
- Synchronizing the MCB
  - The GCB is closed (or at least one GCB is closed in a multiple genset application)
  - The busbar voltage is within the configured operating range
  - The "Enable MCB" (parameter 12923 ↪ p. 231) signal is present, for example discrete input 6 is energized if configured as DI 6
  - The button "Close MCB" has been pressed
- Synchronizing the GCB
  - The MCB is closed
  - The busbar voltage is within the configured operating range
  - Engine delayed monitoring (parameter 3315 ↪ p. 270) and generator stable time (parameter 3415 ↪ p. 227) have expired or "Undelay close GCB" (parameter 12210 ↪ p. 228) is enabled
  - The button "Close GCB" has been pressed

### 4.5.1.3 Dead Bus Closing MCB



The following applies to application mode **A04**.

The unit closes the MCB, if the following conditions are met simultaneously.

The display indicates "MCB dead bus cls".

Automatic operation

- The operating mode AUTOMATIC has been selected
- The parameter "Dead busbar closure MCB" (parameter 3431 ↪ p. 231) is configured On
- The mains voltage is available and within the configured operating range ( ↪ *Chapter 4.4.2.1 "Mains Operating Voltage / Frequency" on page 139*)
- The GCB is open or has been opened for at least the "Transfer time GCB↔MCB" (parameter 3400 ↪ p. 224) (open transition mode only)
- The "Enable MCB" (parameter 12923 ↪ p. 231) signal is present, for example discrete input 6 is energized if configured as DI 6
- The busbar voltage is below the dead bus detection limit (parameter 5820 ↪ p. 224)

Manual operation

- Operating mode MANUAL has been selected
- The parameter "Dead busbar closure MCB" (parameter 3431 ↪ p. 231) is configured "On"
- The mains voltage is available and within the configured operating range ( ↪ *Chapter 4.4.2.1 "Mains Operating Voltage / Frequency" on page 139*)



- The GCB is open or has been opened for at least the "Transfer time GCB→MCB" (parameter 3400 ↗ p. 224) (open transition mode only)
- The "Enable MCB" (parameter 12923 ↗ p. 231) signal is present, for example discrete input 6 is energized if configured so
- The button "Close MCB" has been pressed
- The busbar voltage is below the dead bus detection limit (parameter 5820 ↗ p. 224)

#### 4.5.1.4 Open GCB



*The following applies to application modes **A02**, **A03** and **A04**.*

The GCB will be opened when the "Command GCB open" is issued. The behavior of the GCB open relay depends on the setting of parameter 3403 ↗ p. 225.

If this parameter is configured as "N.O.", the relay energizes to open the GCB, if it is configured as "N.C.", the relay de-energizes to open the GCB.

The GCB will be opened under the following conditions:

- In STOP operating mode after unloading the generator
- In case of a class C alarm or higher
- By pressing the "GCB" or "MCB" softkey (depending on the CB logic which has been set) in MANUAL operating mode
- By pressing the button "stop engine" in MANUAL operating mode
- In the event of an automatic stopping in the AUTOMATIC operating mode (the start request has been terminated or a stop request has been initiated)
- In critical mode (Sprinkler operation), provided that an emergency power operation is not active, and "Close GCB in override" (parameter 4100 ↗ p. 300) has been configured to No
- If "Start without load" has been enabled through the Logics-Manager and the breaker was closed
- By pressing the "MCB" softkey (depending on the CB logic which has been set) in MANUAL operating mode



*The conditions above are only valid if the GCB is closed, whereas the following conditions are valid regardless of the GCB is open or closed.*

- Prior to the MCB closing onto the dead busbar (depending on the CB logic which has been set)
- In case of an alarm of class D or F

### 4.5.1.5 Open MCB



*This parameter **only** applies to application mode **A04**.*

The MCB will be opened when the relay "Command: MCB open" is energized.

The MCB will be opened under the following conditions if the MCB is closed:

- If an emergency power operation is initiated (mains failure) once the generator voltage is within the permissible limits
- Prior to the closure of the GCB (depending on the CB logic which has been set)
- Upon pressing the "MCB" or "GCB" softkey (dependent upon the configured CB logic) in MANUAL operating mode

### 4.5.1.6 Transition Modes (Breaker Logic)

#### Breaker logic "PARALLEL"

Parallel operation is enabled by configuring parameter 3411 ↗ p. 223 to "PARALLEL".



*Parallel breaker logic must be selected for the following operation modes:*

- *Isolated operation*
- *Mains parallel operation*

In the event of an engine start request the following occurs:

- The GCB is synchronized and closed
- The generator assumes load and the adjusted real power or reactive power setpoints are controlled

Following the stop request the following occurs:

- The generator sheds load until real power has reached the "Unload limit" (parameter 3125 ↗ p. 177)
- The generator power factor is controlled to "1.00" (unity)
- The GCB is opened
- The engine is shut down following the configured cool down period



*When a stop command is issued to the engine, soft loading (power reduction) is carried out before opening the GCB, except an alarm of class D or F is present.*

#### Breaker logic "INTERCHANGE"



*The following only applies to application mode **A04**.*

Mains interchange (import/export) real power control is enabled by configuring parameter 3411 ↗ p. 223 to "INTERCHANGE".



*For this breaker logic to function correctly, the mains power measurement must be connected properly.*

*The following applies for the power display:*

- *Positive mains power = export power*
- *Negative mains power = import power*

In the event of a start request, a change is made from mains to generator supply.

The following occurs:

- The GCB is synchronized and closed
- The generator assumes load until the imported mains interchange real power has reached 3 % of the "Generator rated active power" (parameter 1752 ↗ p. 95)
- The MCB is opened

When a stop request has been issued, a change is made from generator to mains supply.

The following occurs:

- The MCB is synchronized and closed
- The generator sheds load until real power has reached the "Unload limit" (parameter 3125 ↗ p. 177)
- The generator power factor is controlled to "1.00" (unity)
- The GCB is opened

#### Breaker logic "CLOSED TRANSIT."



*The following only applies to application mode **A04**.*

Closed transition (make-before-break/overlap synchronization) is enabled by configuring parameter 3411 ↗ p. 223 to "CLOSED TRANSITION".



*The circuit breakers are opened irrespective of the power.*

In the event of an engine start request, a change is made from mains to generator supply.

The following occurs:

- The GCB is synchronized and closed
- The MCB is opened and the generator assumes all loads

After the engine stop request has been issued, a change is made from generator to mains supply.

The following occurs:

- The MCB is synchronized and closed
- The GCB is opened and the mains assume all loads



*The maximum time between the reply from the CB and the CB open command is 500 ms.*

**Breaker logic "OPEN TRANSIT."**



*The following only applies to application mode **A04**.*

Open transition (break-before-make/change over logic) is enabled via configuration of parameter 3411 ↪ p. 223 to "OPEN TRANSITION".

In the event of an engine start request, a change is made from mains to generator supply.

The following occurs:

- The MCB is opened
- The GCB is closed after the time configured in "Transfer time GCB<->MCB" (parameter 3400 ↪ p. 224) has expired.

The following occurs:

- The GCB is opened
- The MCB is closed after the time configured in "Transfer time GCB<->MCB" (parameter 3400 ↪ p. 224) has expired



*The maximum time between the reply from the CB and the CB open command is 500 ms.*

**Breaker logic "EXTERNAL"**

External breaker logic is enabled via configuration of parameter 3411 ↪ p. 223 to "EXTERNAL".

All breaker control (especially the CB closing instructions) must be carried out via master controller (e.g. a PLC).

The easYgen controller always issues additionally the breaker open command under fault conditions and in the breaker unloading states (Unloading GCB) if the stop request is active.

**Overview for application mode A04**

STOP	MANUAL	AUTOMATIC
<b>EXTERNAL:</b> Breaker logic "External"		
In a mains parallel operation, decoupling from the mains is carried out via the MCB or the GCB in the event of a mains failure. The breakers will not automatically close in emergency power operation. Emergency power operation in accordance with European Community Specification DIN VDE 0108 is not possible in this power circuit breaker logic.		
The GCB is opened.	The MCB and the GCB may be manually opened. The circuit breakers are opened for decoupling from the mains.	The GCB is opened if the genset is stopped or if decoupling from the mains, but will not close if the engine is started. The MCB is opened only if decoupling from the mains, and is never closed.

STOP	MANUAL	AUTOMATIC
<p><b>PARALLEL:</b> Breaker logic "Mains parallel operation"</p>		
<p>The MCB and GCB are synchronized to permit continuous mains parallel operation in this breaker logic mode.</p>		
<p>The GCB is opened; the MCB is operated depending on the setting of "Enable MCB" (parameter 12923 ↗ p. 231).</p>	<p>Mains parallel operation can be initiated by pressing the "GCB On" or "MCB On" push-button.</p>	<p>The GCB is synchronized via an add-on request and a mains parallel operation is performed. When a shed-off request is issued, the generator sheds load and opens the GCB and the engine is shut down following the configured cool down period.</p> <p>Emergency power: The emergency power operation is terminated following the expiration of the mains settling time. The MCB is synchronized and closed, putting the system back into a mains parallel operation.</p>
<p><b>OPEN TRANSIT.:</b> Breaker logic "Open transition / change-over / brake-before-make"</p>		
<p>The MCB and GCB are never synchronized in this breaker logic mode.</p>		
<p>The GCB is opened; the MCB is operated depending on the setting of "Enable MCB" (parameter 12923 ↗ p. 231).</p>	<p>A change can be made to either generator or mains operation by pressing either the "GCB On" or "MCB On" push-button. The "STOP" push-button opens the GCB and simultaneously stops the engine.</p>	<p>A change is made to generator operation through an add-on request. Once the add-on request is terminated, the system changes back to mains operation. The MCB is closed when the busbar is dead, even if there has not been an add-on request. Emergency power operations are terminated following the expiration of the mains settling timer. The GCB opens and the MCB closes, transferring all loads to the mains.</p>
<p><b>CLOSED TRANSIT.:</b> Breaker logic "Closed transition / make-before-brake / overlap synchronization"</p>		
<p>The MCB and the GCB are synchronized, in order to avoid a dead busbar in this breaker logic mode. Immediately after the synchronization of one breaker, the other is opened. Continuous mains parallel operation is not possible.</p>		
<p>The GCB is opened; the MCB is operated depending on the setting of "Enable MCB" (parameter 12923 ↗ p. 231).</p>	<p>Synchronization of either the generator or the mains can be initiated by pressing the "GCB On" or "MCB On" push-button.</p>	<p>The GCB is synchronized via an add-on request. After the GCB closes the MCB is opened. Following the shed-off request being issued, the MCB is synchronized and closed. After the MCB has closed the GCB is opened.</p> <p>Emergency power: The emergency power operation is terminated following the expiration of the mains settling time and the MCB synchronizing to the generator. The MCB closes and the GCB opens immediately afterwards.</p>

## Configuration

Configure Application > Configure Breakers > Parameters

STOP	MANUAL	AUTOMATIC
<p><b>INTERCHANGE:</b> Breaker logic "Soft loading / interchange synchronization"</p> <p>The MCB and the GCB are synchronized, in order to avoid a dead busbar in this breaker logic mode. The operation of a breaker under load is avoided by utilizing the ability to soft load. Continuous mains parallel operation is not possible with this breaker logic.</p> <p>Following the shed-off request, the MCB synchronizes and closes, the generator soft unloads to the mains and the GCB opens. After the GCB is open the engine is stopped following the expiration of the configured cool down period.</p>		
<p>The GCB is opened; the MCB is operated depending on the setting of "Enable MCB" (parameter 12923 ↗ p. 231).</p>	<p>Synchronization of either the generator or the mains can be initiated by pressing the "GCB On" or "MCB On" push-button.</p>	<p>Via an engine request, the GCB is synchronized and the generator power is increased. The MCB is then opened. Following the disabling of the engine request, the MCB is reverse synchronized and the GCB is then opened.</p> <p>Emergency power: The emergency power operation is terminated following the expiration of the mains settling time. The MCB closes, the load is transferred, and the GCB opens.</p>

### Overview for application mode A03

STOP	MANUAL	AUTOMATIC
<p><b>PARALLEL:</b> Breaker logic "Mains parallel"</p> <p>This operation mode may be used both in the case of an isolated system, an isolated parallel system, and a system that is operated in mains parallel.</p>		
<p>The GCB is opened.</p>	<p>Mains parallel operation can be performed via the "GCB On" push-button.</p>	<p>The GCB is synchronized via an add-on request and mains parallel operation is performed.</p> <p>When a shed-off request is issued, the generator sheds load, the GCB is opened, and the engine is shut down following the configured cool down period.</p>

#### 4.5.1.7 Parameters

ID	Parameter	CL	Setting range [Default]	Description
3401	<b>Application mode</b>	2		<p>The unit may be configured for four different application modes. The discrete inputs and relay outputs are pre-defined dependent upon the selected application mode. Only the screens and functions that pertain to the application mode selected are displayed. The single line diagram in the main screen will change.</p> <p>Refer to ↗ <i>Chapter 6 "Application" on page 417</i> for additional information.</p>
			None	<p><b>Application mode A01</b></p> <p>The control unit will function as an engine start/stop control with generator and engine protection. All necessary inputs and outputs are assigned and pre-defined.</p>
			GCB open	<p><b>Application mode A02</b></p> <p>The control unit will function as an engine start/stop control with generator and engine protection. The control unit can only open the GCB. All necessary inputs and outputs are assigned and pre-defined.</p>

ID	Parameter	CL	Setting range [Default]	Description
			GCB	<b>Application mode <a href="#">A03</a></b> The control unit will function as a 1 CB unit. The control unit performs full control like synchronizing, opening and closing the GCB with generator and engine protection. All necessary inputs and outputs are assigned and pre-defined.
			[GCB/MCB]	<b>Application mode <a href="#">A04</a></b> The control unit will function as a 2 CB unit. The control unit performs full control like synchronizing, opening and closing the GCB and the MCB with generator and engine protection. The GCB/MCB perform also full load transfer via open/closed transition, interchange and parallel mode. All necessary inputs and outputs are assigned and pre-defined.
3411	<b>Breaker transition mode</b>	2	Parallel / Interchange / Closed Transit. / Open Transition / External  [Parallel]	The control unit automatically controls the two breakers (MCB and GCB).  <b>Notes</b> This parameter <b>only</b> applies to application mode <a href="#">A04</a> . For a detailed explanation for each mode refer to <a href="#">Chapter 4.5.1.6 "Transition Modes (Breaker Logic)"</a> on page 218. The unit provides two alternative transition modes, which may be activated temporarily via the LogicsManager and override the transition mode configured in this parameter.
3412	<b>Breaker transition mode 1</b>	2	Parallel / Interchange / Closed Transit. / Open Transition / External  [Parallel]	The control unit automatically controls the two breakers (MCB and GCB).  <b>Notes</b> This parameter <b>only</b> applies to application mode <a href="#">A04</a> . For a detailed explanation for each mode refer to <a href="#">Chapter 4.5.1.6 "Transition Modes (Breaker Logic)"</a> on page 218.
12931	<b>Transition mode 1</b>	2	Determined by LogicsManager  [[0 & 1] & 1]	Once the conditions of the LogicsManager have been fulfilled, the transition mode configured in parameter 3412 <a href="#">p. 223</a> will be used instead of the standard transition mode configured in parameter 3411 <a href="#">p. 223</a> . For information on the LogicsManager and its default settings see <a href="#">Chapter 9.4.1 "LogicsManager Overview"</a> on page 689.  <b>Notes</b> This parameter <b>only</b> applies to application mode <a href="#">A04</a> . Alternative transition mode 1 has priority over alternative transition mode 2, i.e. if both LogicsManager functions (parameters 12931 <a href="#">p. 223</a> and 12932 <a href="#">p. 224</a> ) are TRUE, breaker transition mode 1 (parameter 3412 <a href="#">p. 223</a> ) will be used.

## Configuration

Configure Application > Configure Breakers > Parameters

ID	Parameter	CL	Setting range [Default]	Description
3413	<b>Breaker transition mode 2</b>	2	Parallel / Interchange / Closed Transit. / Open Transition / External  <b>[Parallel]</b>	The control unit automatically controls the two breakers (MCB and GCB).
			<b>Notes</b> This parameter <b>only</b> applies to application mode <b>A04</b> . For a detailed explanation for each mode refer to <a href="#">Chapter 4.5.1.6 "Transition Modes (Breaker Logic)"</a> on page 218.	
12932	<b>Transition mode 2</b>	2	Determined by LogicsManager  <b>[(0 &amp; 1) &amp; 1]</b>	Once the conditions of the LogicsManager have been fulfilled, the transition mode configured in parameter 3412 <a href="#">p. 223</a> will be used instead of the standard transition mode configured in parameter 3411 <a href="#">p. 223</a> .
			<b>Notes</b> This parameter <b>only</b> applies to application mode <b>A04</b> . Alternative transition mode 1 has priority over alternative transition mode 2, i.e. if both LogicsManager functions (parameters 12931 <a href="#">p. 223</a> and 12932 <a href="#">p. 224</a> ) are TRUE, breaker transition mode 1 (parameter 3412 <a href="#">p. 223</a> ) will be used. For information on the LogicsManager and its default settings see <a href="#">Chapter 9.4.1 "LogicsManager Overview"</a> on page 689.	
3400	<b>Transfer time GCB↔MCB</b>	2	0.10 to 99.99 s  <b>[1.00 s]</b>	Switching from generator supply to mains supply or from mains supply to generator supply occurs automatically if the operating conditions have been met.  The time between the reply "power circuit breaker is open" and a close pulse is set by this parameter. This time applies for both directions. During this time the consumers are de-energized.
			<b>Notes</b> This parameter <b>only</b> applies to application mode <b>A04</b> . This is only valid, if parameter 3411 <a href="#">p. 223</a> is configured to OPEN TRANSITION	
5820	<b>Dead bus detection max. volt.</b>	2	0 to 30 %  <b>[10 %]</b>	If the busbar voltage falls below this percentage of the busbar 1 rated voltage (parameter 1781 <a href="#">p. 95</a> ), a dead bus condition is detected and the logical command variable 02.21 (Busbar 1 is dead) becomes TRUE.



4.5.1.8 Breakers GCB

General notes

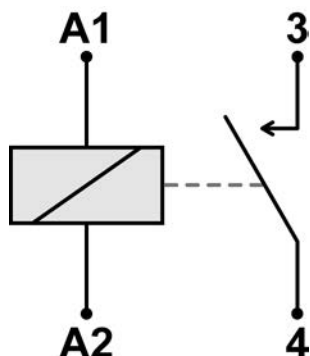

**Normally Open (N.O.) contacts**

The relay (discrete output) must be energized to close the contact.

Fig. 86: Normally Open contacts - schematic

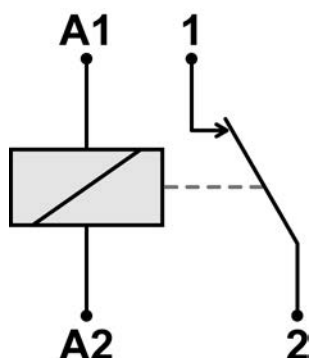

**Normally Closed (N.C.) contacts**

The relay (discrete output) must be energized to open the contact.

Fig. 87: Normally Closed contacts - schematic

ID	Parameter	CL	Setting range [Default]	Description
3403	GCB open relay	2	[N.O.]	Normally open: The relay "command: GCB open" will be energized to open the GCB and will be de-energized again after the discrete input "Reply GCB" is energized to signal the control that the GCB is open.
			N.C.	Normally closed: The relay "command: GCB open" will be de-energized to open the GCB and will be energized again after the discrete input "Reply GCB" is energized to signal the control that the GCB is open.
			Not used	A GCB open relay is not used and relay R7 (Command: open GCB) is freely programmable. In this case, parameter 3414 ↗ p. 225 must be configured to "Constant" to open the breaker.
			<b>Notes</b> This parameter <b>only</b> applies to application mode <b>A02 A03 A04</b> .	
3414	GCB close command	2	Impulse	The relay "Command: GCB close" issues an add-on pulse. If the relay is configured in this manner a holding coil and sealing contacts must be installed externally to the control unit. The DI "Reply GCB" is used to identify closed contacts.

## Configuration

Configure Application > Configure Breakers > Breakers GCB

ID	Parameter	CL	Setting range [Default]	Description
			[Constant]	<p>The relay "Command: close GCB" may be wired directly into the holding circuit for the power circuit breaker. If this method is utilized it is recommended that isolation relays are used.</p> <p>After the connect pulse has been issued and the reply of the power circuit breaker has been received, the relay "Command: close GCB" remains energized. If a class C alarm or higher occurs or a GCB open command is issued, this relay de-energizes.</p>
				<p><b>Notes</b></p> <p>In both cases the relay "Command: GCB open" energizes to open the GCB if parameter 3403 ↗ p. 225 is not configured as "Not used".</p> <p>This parameter <b>only</b> applies to application modes <b>A03</b> and <b>A04</b>.</p>
3416	GCB time pulse	2	0.10 to 0.50 s [0.50 s]	<p>The time of the pulse output may be adjusted to the breaker being utilized.</p>
				<p><b>Notes</b></p> <p>This parameter <b>only</b> applies to application mode <b>A02</b> <b>A03</b> <b>A04</b>.</p>
5729	Synchronization GCB	2	[Slip frequency]	<p>The frequency controller adjusts the frequency in a way, that the frequency of the source (generator) is marginal greater than the target (busbar). When the synchronizing conditions are reached, a close command will be issued. The slipping frequency depends on the setting of "Slip frequency offset" (parameter 5502 ↗ p. 307).</p>
			Phase matching	<p>The frequency controller adjusts the phase angle of the source (generator) to that of the target (busbar), in view of turning the phase difference to zero.</p>
				<p><b>Notes</b></p> <p>This parameter <b>only</b> applies to application mode <b>A04</b>.</p>
5700	Voltage differential GCB	2	0.50 to 20.00 % [5.00 %]	<p>The maximum permissible voltage differential for closing the generator circuit breaker is configured here.</p> <p>If the difference between generator and busbar voltage does not exceed the value configured here and the generator voltage is within the operating voltage window (parameters 5800 ↗ p. 110 and 5801 ↗ p. 110), the "Command: GCB close" may be issued.</p>
				<p><b>Notes</b></p> <p>This value refers to the generator rated voltage (parameter 1766 ↗ p. 95).</p> <p>This parameter <b>only</b> applies to application modes <b>A03</b> and <b>A04</b>.</p>
5701	Positive frequency differential GCB	2	0.02 to 0.49 Hz [+0.18 Hz]	<p>The prerequisite for a close command being issued for the GCB is that the differential frequency is below the configured differential frequency.</p> <p>This value specifies the upper frequency (positive value corresponds to positive slip → generator frequency is higher than the busbar frequency).</p>
				<p><b>Notes</b></p> <p>This parameter <b>only</b> applies to application modes <b>A03</b> and <b>A04</b>.</p>
5702	Negative frequency differential GCB	2	-0.49 to 0.00 Hz [-0.10 Hz]	<p>The prerequisite for a close command being issued for the GCB is that the differential frequency is above the configured differential frequency.</p> <p>This value specifies the lower frequency limit (negative value corresponds to negative slip → generator frequency is less than the busbar frequency).</p>
				<p><b>Notes</b></p> <p>This parameter <b>only</b> applies to application modes <b>A03</b> and <b>A04</b>.</p>

ID	Parameter	CL	Setting range [Default]	Description
5703	Maximum permissible positive phase angle GCB	2	0.0 to 60.0° [7.0°]	The prerequisite for a close command being issued for the GCB is that the leading phase angle between generator and busbar is below the configured maximum permissible angle.
			<b>Notes</b> This parameter <b>only</b> applies to application modes <b>A03</b> and <b>A04</b> . This parameter is only displayed, if parameter 5729 ↗ p. 226 is configured to "Phase matching".	
5704	Maximum permissible negative phase angle GCB	2	-60.0 to 0.0° [-7.0°]	The prerequisite for a close command being issued for the GCB is that the lagging phase angle between generator and busbar is below the configured maximum permissible angle.
			<b>Notes</b> This parameter <b>only</b> applies to application modes <b>A03</b> and <b>A04</b> . This parameter is only displayed, if parameter 5729 ↗ p. 226 is configured to "Phase matching".	
5707	Phase matching GCB dwell time	2	0.0 to 60.0 s [3.0 s]	This is the minimum time that the generator voltage, frequency, and phase angle must be within the configured limits before the breaker will be closed.
			<b>Notes</b> This parameter <b>only</b> applies to application modes <b>A03</b> and <b>A04</b> . This parameter is only displayed, if parameter 5729 ↗ p. 226 is configured to "Phase matching".	
3432	Dead bus closure GCB	2	[On]	A dead busbar closure is allowed if the required conditions are met.
			Off	A GCB close command to a dead busbar is prevented. Synchronization is still possible.
			<b>Notes</b> This parameter <b>only</b> applies to application modes <b>A03</b> and <b>A04</b> .	
3415	Generator stable time	2	0 to 99 s [2 s]	The time configured here begins to count down once the engine monitoring delay timer has expired. This permits for an additional delay time before the breaker is closed in order to ensure that none of the engine delayed watchdogs trips.  It is possible to bypass this delay time through the LogicsManager (parameter 12210 ↗ p. 228) in the event an emergency operation condition (mains failure) occurs.  Unnecessary CB switching operations and voltage interruptions should be avoided by utilizing this parameter.
			<b>Notes</b> This parameter <b>only</b> applies to application mode <b>A02</b> , <b>A03</b> , <b>A04</b> .	
5705	Closing time GCB	2	40 to 300 ms [80 ms]	The inherent closing time of the GCB corresponds to the lead-time of the close command.  The close command will be issued independent of the differential frequency at the entered time before the synchronous point.
			<b>Notes</b> This parameter <b>only</b> applies to application modes <b>A03</b> and <b>A04</b> .	

## Configuration

ID	Parameter	CL	Setting range [Default]	Description
15161	<b>Inhibit dead bus closure GCB</b>	2	Determined by LogicsManager [[0 & 1] & 1]	If active the deadbus closure of the GCB can be inhibited.
			<b>Notes</b> For information on the LogicsManager and its default settings see <a href="#">Chapter 9.4.1 "LogicsManager Overview" on page 689.</a>	
12210	<b>Undelay close GCB</b>	2	Determined by LogicsManager [[04.09 & 1] & 1]	Once the conditions of the LogicsManager have been fulfilled the GCB will be closed immediately (without waiting for engine speed delay and generator stable timer to expire). When using the standard setting, the GCB will be closed without delay in emergency power operation.
			<b>Notes</b> This parameter <b>only</b> applies to application modes <b>A03</b> and <b>A04</b> . Usually the dead busbar negotiation is started with reaching the generator frequency and voltage operating window. But during the function "undelayed close GCB", the dead busbar negotiation is executed from the moment on the engine has reached the firing speed. <i>Through starting the dead bus bar negotiation earlier, the overall time before closing the GCB can be shorten.</i> For information on the LogicsManager and its default settings see <a href="#">Chapter 9.4.1 "LogicsManager Overview" on page 689.</a>	
3405	<b>GCB auto unlock</b>	2		This is used for special circuit breakers to put the GCB into a defined initial state or to enable closing at all.
			Yes	Before every close-pulse, an open-pulse is issued for defined duration (parameter 5708 <a href="#">p. 228</a> . A CB close pulse is enabled only after the open pulse is issued.
			<b>[No]</b>	The CB close pulse is enabled without being preceded by a CB open pulse.
			<b>Notes</b> This parameter <b>only</b> applies to application modes <b>A03</b> and <b>A04</b> .	
5708	<b>GCB open time pulse</b>	2	0.10 to 9.90 s [1.00 s]	This time defines the length of the GCB open time pulse, if the automatic switch unblocking GCB is activated.
			<b>Notes</b> This parameter <b>only</b> applies to application modes <b>A03</b> and <b>A04</b> .	
12976	<b>GCB open in MAN</b>	2	Determined by LogicsManager	With the rising edge of this LogicsManager equation a GCB open command in operating mode MANUAL is initiated. The state TRUE of this LM inhibits the GCB close command in MANUAL.
			<b>Notes</b> This parameter <b>only</b> applies to application modes <b>A03</b> and <b>A04</b> . For information on the LogicsManager and its default settings see <a href="#">Chapter 9.4.1 "LogicsManager Overview" on page 689.</a>	
12977	<b>GCB close in MAN</b>	2	Determined by LogicsManager	With the rising edge of this LogicsManager equation a GCB close command in operating mode MANUAL is initiated. Precondition: deactivated "GCB open in MAN"

ID	Parameter	CL	Setting range [Default]	Description
				<p><b>Notes</b></p> <p>This parameter <b>only</b> applies to application modes <b>A03</b> and <b>A04</b>.</p> <p>For information on the LogicsManager and its default settings see <a href="#">Chapter 9.4.1 "LogicsManager Overview" on page 689</a>.</p>
8825	Phase angle compensation GCB	2		The phase angle between generator voltage and generator busbar voltage can be compensated according to an installed power transformer between generator and busbar.
			On	The compensation is active. The phase will be compensated according to the value configured in parameter 8824 <a href="#">p. 229</a> .
				<p><b>Notes</b></p> <p>Measured values 181 'Ph.ang.busb1-gen.L12' and 184 'Ph.ang.mns.busb1 L12' are not changed but the compensated (8824 <a href="#">p. 229</a>) values are taken for synchronization control and synchroscope display.</p>
			[Off]	The compensation is inactive. The phase angle is directly taken from the measurement.
				<p><b>Notes</b></p> <p>WARNING: Ensure the following parameters are configured correctly to prevent erroneous synchronization settings. Incorrect wiring of the system cannot be compensated for with this parameter!</p> <p>Please check during initial commissioning the phase angle and the synchronization with a zero voltmeter.</p> <p><b>Recommendation:</b> For safety reasons, please mark the easYgen with a label showing the configured phase angle compensation.</p> <p>Refer to <a href="#">Chapter 6.4.13 "Phase Angle Compensation" on page 465</a> for details.</p>
8824	Phase angle GCB	2	-180 to 180° [0°]	The phase angle compensation corrects the degree between generator voltage and busbar voltage. The configured degree is added to the real measured phase angle.

#### 4.5.1.9 Breakers MCB

##### General notes



The following parameters are **only** applicable for application mode **A04**.

ID	Parameter	CL	Setting range [Default]	Description
3417	MCB time pulse	2	0.10 to 0.50 s [0.50 s]	<p>Breaker pulse duration to close the MCB</p> <p>The time of the pulse output may be adjusted to the breaker being utilized.</p>
5730	Synchronization MCB	2	[Slip frequency]	The frequency controller adjusts the frequency in a way, that the frequency of the source (busbar) is marginal greater than the target (mains). When the synchronizing conditions are reached, a close command will be issued. The slipping frequency is positive to avoid reverse power.

## Configuration

Configure Application > Configure Breakers > Breakers MCB

ID	Parameter	CL	Setting range [Default]	Description
			Phase matching	The frequency controller adjusts the phase angle of the source (busbar) to that of the target (mains), in view of turning the phase difference to zero.
5709	<b>MCB sync. with separate slip</b>	2	On	The MCB is synchronized with an individual slip frequency (also negative).  <b>Notes</b> The setting for the slipping frequency (parameter 5647 ↗ p. 230) via display is located under 'configure frequency control'.
			[Off]	The MCB is synchronized with the same slip frequency like the GCB (parameter 5502 ↗ p. 307).  <b>Notes</b> This parameter <b>only</b> applies to application mode <b>A04</b> .
5647	<b>MCB slip freq. setpoint offset</b>	2	-0.50 ... 0...50 Hz	Individual frequency offset for the MCB and LS5 synchronization. This value can be a positive or negative offset. The value is valid as long as the parameter 'MCB synchronization with separate slip' On/Off' (parameter 5709 ↗ p. 230) is set to 'On' .
			[-0.10 Hz]	<b>Notes</b> This setting is in the display located under 'configure frequency control'. This parameter <b>only</b> applies to application mode <b>A04</b> .
5710	<b>Voltage differential MCB</b>	2	0.50 to 20.00 %	The maximum permissible voltage differential for closing the mains circuit breaker is configured here.
			[5.00 %]	<b>Notes</b> This value refers to the generator rated voltage (parameter 1766 ↗ p. 95) and mains rated voltage (parameter 1768 ↗ p. 95).  If the difference between mains and busbar voltage does not exceed the value configured here and the mains voltage is within the operating voltage window (parameters 5810 ↗ p. 140 and 5811 ↗ p. 140), the "Command: MCB close" may be issued.
5711	<b>Pos. freq. differential MCB</b>  (Positive frequency differential MCB)	2	0.02 to 0.49 Hz [0.18 Hz]	The prerequisite for a connect command being issued for the MCB is that the differential frequency is below the configured differential frequency.  This value specifies the upper frequency (positive value corresponds to positive slip → busbar frequency is higher than the mains frequency).
5712	<b>Neg. freq. differential MCB</b>  (Negative frequency differential MCB)	2	-0.49 to 0.00 Hz [-0.10 Hz]	The prerequisite for a connect command being issued for the MCB is that the differential frequency is above the configured differential frequency.  This value specifies the lower frequency limit (negative value corresponds to negative slip → busbar frequency is less than the mains frequency).
5713	<b>Max positive phase angle MCB</b>  (Maximum permissible positive phase angle MCB)	2	0.0 to 60.0°	The prerequisite for a connect command being issued for the MCB is that the leading phase angle between busbar and mains is below the configured maximum permissible angle.
			[7.0°]	<b>Notes</b> This parameter is only displayed, if parameter 5730 ↗ p. 229 is configured to "Phase matching".
5714	<b>Max negative phase angle MCB</b>	2	-60.0 to 0.0° [-7.0°]	The prerequisite for a connect command being issued for the MCB is that the lagging phase angle between busbar and mains is below the configured maximum permissible angle.

ID	Parameter	CL	Setting range [Default]	Description
	(Maximum permissible negative phase angle MCB)			<p><b>Notes</b></p> <p>This parameter is only displayed, if parameter 5730 ↗ p. 229 is configured to "Phase matching".</p>
5717	<b>Phase matching MCB dwell time</b>	2	0.0 to 60.0 s [3.0 s]	<p>This is the minimum time that the generator/busbar voltage, frequency, and phase angle must be within the configured limits before the breaker will be closed.</p> <p><b>Notes</b></p> <p>This parameter is only displayed, if parameter 5730 ↗ p. 229 is configured to "Phase matching".</p>
3431	<b>Dead bus closure MCB</b>	2	[On] Off	<p>A dead busbar closure is allowed if the required conditions are met.</p> <p>An MCB close command to a dead busbar is prevented. Synchronization is still possible.</p>
12923	<b>Enable MCB</b>	2	Determined by LogicsManager [(09.06 & !08.07) & !07.05]	<p>Once the conditions of the LogicsManager have been fulfilled the MCB will be enabled.</p> <p><b>Notes</b></p> <p>DI 6 is pre-assigned by default to this function, but may be configured freely.</p> <p>For information on the LogicsManager and its default settings see ↗ Chapter 9.4.1 "LogicsManager Overview" on page 689.</p>
5715	<b>Closing time MCB</b>	2	40 to 300 ms [80 ms]	<p>The inherent closing time of the MCB corresponds to the lead-time of the close command.</p> <p>The close command will be issued independent of the differential frequency at the entered time before the synchronous point.</p>
3407	<b>MCB auto unlock</b>	2	[No] Yes	<p>This is used for special circuit breakers to put the MCB into a defined initial state or to enable closing at all.</p> <p>Before every close-pulse, an open-pulse is issued for defined duration (parameter 5718 ↗ p. 231). A CB close pulse is enabled only after the open pulse is issued.</p> <p>The CB close pulse is enabled without being preceded by a CB open pulse.</p>
5718	<b>MCB open time pulse</b>	2	0.10 to 9.90 s [1.00 s]	<p>This time defines the length of the MCB open time pulse, if the automatic switch unblocking MCB is activated.</p>
8841	<b>Phase angle compensation MCB</b>	2	[Off] On	<p>The phase angle between busbar voltage and mains voltage can be compensated according to an installed power transformer between busbar and mains.</p> <p>The compensation is active. The phase will be compensated according the value configured in parameter 8842 ↗ p. 232.</p> <p><b>Notes</b></p> <p>Measured values 181 'Ph.ang.busb1-gen.L12' and 184 'Ph.ang.mns.busb1 L12' are not changed but the compensated (8842 ↗ p. 232) values are taken for synchronization control and synchroscope display.</p> <p>The compensation is inactive. The phase angle is directly taken from the measurement.</p>

ID	Parameter	CL	Setting range [Default]	Description
				<p><b>Notes</b></p> <p>WARNING: Ensure the following parameters are configured correctly to prevent erroneous synchronization settings. Incorrect wiring of the system cannot be compensated for with this parameter!</p> <p>Please check during initial commissioning the phase angle and the synchronization with a zero voltmeter.</p> <p><b>Recommendation:</b> For safety reasons, please mark the easYgen with a label showing the configured phase angle compensation.</p> <p>Refer to <a href="#">Chapter 6.4.13 "Phase Angle Compensation"</a> on page 465 for details.</p> <p>This parameter <b>only</b> applies to application mode <b>A04</b>.</p>
8842	<b>Phase angle MCB</b>	2	-180 to 180° [0°]	<p>The phase angle compensation corrects the degree between busbar voltage and mains voltage. The configured degree is added to the real measured phase angle.</p> <p><b>Notes</b></p> <p>This parameter <b>only</b> applies to application mode <b>A04</b>.</p>
12974	<b>MCB open in MAN</b>	2	Determined by LogicsManager	<p>With the rising edge of this LogicsManager equation a MCB open command in operating mode MANUAL is initiated. The state TRUE of this LM inhibits the MCB close command in MANUAL.</p> <p><b>Notes</b></p> <p>This parameter <b>only</b> applies to application mode <b>A04</b>.</p> <p>For information on the LogicsManager and its default settings see <a href="#">Chapter 9.4.1 "LogicsManager Overview"</a> on page 689.</p>
12975	<b>MCB close in MAN</b>	2	Determined by LogicsManager	<p>With the rising edge of this LogicsManager equation a MCB close command in operating mode MANUAL is initiated. Precondition: deactivated "MCB open in MAN"</p> <p><b>Notes</b></p> <p>This parameter <b>only</b> applies to application mode <b>A04</b>.</p> <p>For information on the LogicsManager and its default settings see <a href="#">Chapter 9.4.1 "LogicsManager Overview"</a> on page 689.</p>

## 4.5.1.10 Synchronization

### General notes



The following parameters are **only** applicable for application modes **A03** **A04**.



ID	Parameter	CL	Setting range [Default]	Description
5728	<b>Synchronization mode</b>	2	Off	<p>The synchronization is disabled; the frequency and voltage adaptation for synchronization is not active.</p> <p>In operation mode AUTO the easYgen allows the external GCB closing in synchronization mode "Off" if:</p> <ul style="list-style-type: none"> <li>■ Start request in automatic active</li> <li>■ Generator is in operating range</li> <li>■ The engine start procedure is finished</li> </ul> <p>In operation mode AUTO the easYgen allows the external MCB closing in synchronization mode "Off" if:</p> <ul style="list-style-type: none"> <li>■ Mains is in the operating range</li> </ul>
			Permissive	<p>The unit acts as a synch check device. The unit will not issue speed or voltage bias commands to achieve a synchronization, but if phase matching synchronization conditions are matched (frequency, phase, voltage and phase angle), the control will issue a breaker close command.</p> <p>There are two different functionalities of this option depending on the setting of parameter 3414 ↗ p. 225 (GCB close command).</p> <ul style="list-style-type: none"> <li>■ GCB close command set to "Impulse": The GCB close command is pulsed as long as the synchronization conditions are matched.</li> <li>■ GCB close command set to "Constant": The GCB close command remains enabled as long as the synchronization conditions are matched.</li> </ul>
			Check	<p>Used for checking a synchronizer prior to commissioning.</p> <p>The control actively synchronizes generator(s) by issuing speed and voltage bias commands, but does not issue a breaker closure command for synchronizing.</p>
			[Run]	<p>Normal operating mode. The control actively synchronizes and issues breaker closure commands.</p>
			Controlled by LM	<p>The synchronization mode may be selected by enabling one of the respective LogicsManager functions (parameters 12907 ↗ p. 233, 12906 ↗ p. 234, or 12908 ↗ p. 234).</p> <p>If none of these parameters is enabled, the synchronization is disabled.</p> <p>If more than one of these parameters is enabled, the following priority is valid:</p> <ul style="list-style-type: none"> <li>■ 1. PERMISSIVE</li> <li>■ 2. CHECK</li> <li>■ 3. RUN</li> </ul>
			<b>Notes</b>	
12907	<b>Syn. mode PERMISS.</b>  (Synchronization mode PERMISSIVE)	2	Determined by LogicsManager  [[0 & 1] & 1]	<p>Once the conditions of the LogicsManager have been fulfilled the PERMISSIVE synchronization mode will be enabled.</p>
			<b>Notes</b>	

ID	Parameter	CL	Setting range [Default]	Description
12906	<b>Syn. mode CHECK</b>  (Synchronization mode CHECK)	2	Determined by LogicsManager  [[0 & 1] & 1]	Once the conditions of the LogicsManager have been fulfilled the CHECK synchronization mode will be enabled.
				<b>Notes</b>  For information on the LogicsManager and its default settings see <a href="#">Chapter 9.4.1 "LogicsManager Overview" on page 689.</a>
12908	<b>Syn. mode RUN</b>  (Synchronization mode RUN)	2	Determined by LogicsManager  [[0 & 1] & 1]	Once the conditions of the LogicsManager have been fulfilled the RUN synchronization mode will be enabled.
				<b>Notes</b>  For information on the LogicsManager and its default settings see <a href="#">Chapter 9.4.1 "LogicsManager Overview" on page 689.</a>
15157	<b>Synchroscope autom. to front</b>  (Synchroscope automatic to front)	2	On	The synchroscope screen automatically appears on the main screen, when the synchronization becomes active.
			[Off]	Functionality deactivated.

## 4.5.1.11 Neutral Interlocking

### General Notes

The Neutral Interlocking feature controls a Neutral Contactor (NC) of each generator. The rule is that only one neutral contactor of all running generators are closed. The Logic ensures that with changing of generators the neutral link is passed over to another running generator. Refer to [Chapter 6.4.16 "Neutral Interlocking" on page 473](#) for more information.

ID	Parameter	CL	Setting range [Default]	Description
1840	<b>Neutral interlocking</b>	2	On	Neutral interlocking is enabled. The command variable 03.39 Close neutral contactor is activated and the DI 12 is used for the NC feedback. The unit monitors the NC feedback according to the close order.
			[Off]	Neutral interlocking is disabled. The NC monitoring is disabled.
1841	<b>Priority</b>	2	1 ... 32 [1]	The priority determines which NC is closed, if multiple gens are running in the same segment.



*To make use of the Close neutral interlocking contactor status, configure a discrete output relay DO x to react for 03.39.*

## 4.5.2 Inputs And Outputs

### 4.5.2.1 Analog Inputs

ID	Parameter	CL	Setting range [Default]	Description
3631	Display temperature in	1	[°C ]	The temperature is displayed in °C (Celsius).
			°F	The temperature is displayed in °F (Fahrenheit).
			<b>Notes</b>	The J1939 SPN temperature visualization values are shown in °F.
3630	Display pressure in	1	[bar ]	The pressure is displayed in Bar.
			psi	The pressure is displayed in psi.
			<b>Notes</b>	The J1939 SPN pressure visualization values are shown in psi.

#### 4.5.2.1.1 Characteristic Curves Setup

##### General notes

The characteristic curves of "Table A" and "Table B" (freely configurable over 9 defined percentage points) are independently configurable and can be used among other predefined curves for each of the analog inputs. Each percentage point may be scaled to related values measured from the analog input (0 to 250/500/2500 Ohms, 0 to 10 V, or 0 to 20 mA), so that the actual display reflects the measured values (i.e. 200 to 600 kW).

The created characteristic curves can be set for visualization and monitoring via the configuration to "Table A" (for Table A) as well as "Table B" (for Table B).

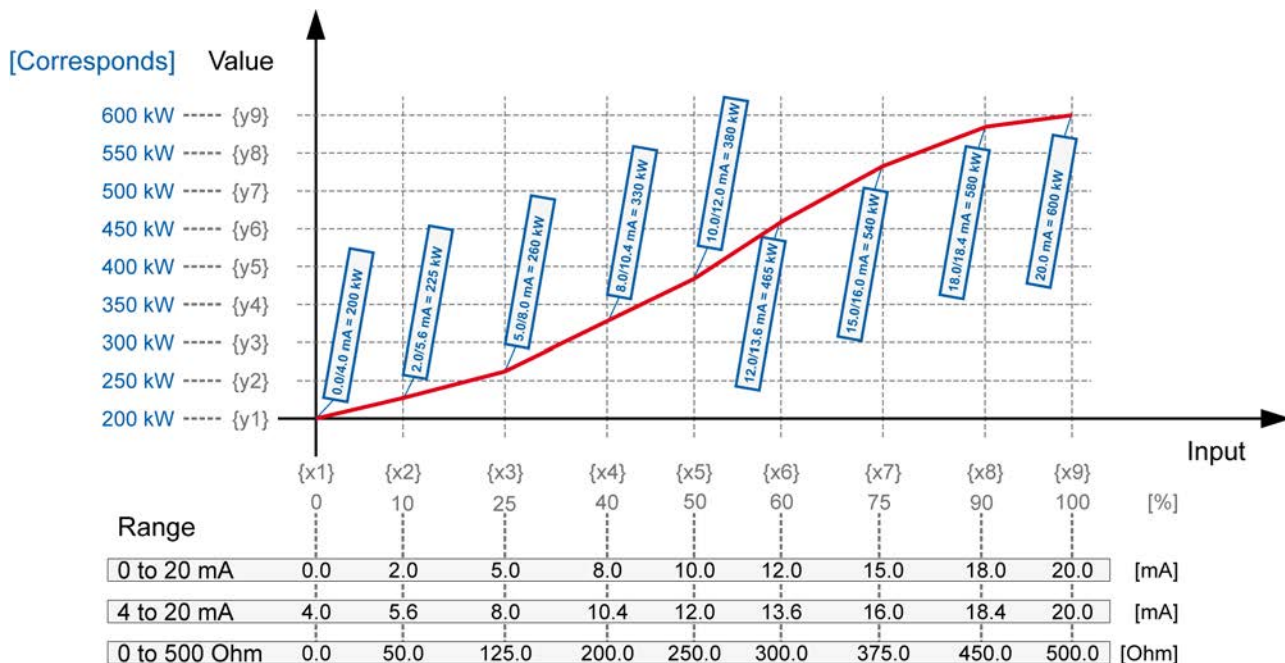

Fig. 88: Characteristic curves (example table)

The X and Y junction may be moved within the range of values and the space between setpoints can be nonuniform.

## Configuration

When configuring the X coordinates, ensure the coordinates always increase in scale continuously.

In the following example the first set of x/y coordinates is correct and the second set of x/y coordinates is wrong:

X-coordinate ( <b>correct</b> )	0 %	10 %	20 %	40 %	50 %	60 %	80 %	90 %	100 %
Y-coordinate	-100	-95	-50	-10	+3	+17	+18	+100	+2000
X-coordinate ( <b>wrong</b> )	0 %	10 %	20 %	60 %	20 %	30 %	80 %	40 %	100 %
Y-coordinate	-100	-50	-95	+18	+17	+3	-10	+2000	+100



*If the first X coordinate is >0 %, all values smaller than the first X value will be output with the first Y value.  
If the last Y value is <100 %, all higher values will be output with the value of Y9.*



*All parameters used to configure the characteristic curve follow the samples listed below.*

- Refer to for the parameter IDs of the individual parameters for all scaling points of tables 'A' and 'B'.

ID	Parameter	CL	Setting range [Default]	Description
3560	Table {A/B} X-value {1..9}	2	0 to 100 % [2 %]	The analog input is assigned to a curve. This parameter defines the actual percentage assigned to each of the nine points along the X-axis of the total range of the selected hardware for analog input.
			<b>Example</b> If a 0 to 20 mA input is configured and the X1-coordinate = 0 %, then the value configured for Y1 is output for an input of 0 mA.	
3550	Table {A/B} Y-value {1..9}	2	-9999 to 9999 [0]	This parameter defines the Y-coordinate (the displayed and monitored value) at the corresponding X-coordinate.
			<b>Example</b> If a 0 to 20 mA input is configured and the X2-coordinate = 10 %, then the value configured for the Y2-coordinate is output for an input of 2 mA.	

### Parameter IDs for all scaling points

Scaling point no.	1	2	3	4	5	6	7	8	9
Table A - X value	3560	3561	3562	3563	3564	3565	3566	3567	3568
Table A - Y value	3550	3551	3552	3553	3554	3555	3556	3557	3558
Table B - X value	3610	3611	3612	3613	3614	3615	3616	3617	3618
Table B - Y value	3600	3601	3602	3603	3604	3605	3606	3607	3608

4.5.2.1.2 Analog Inputs 1 to 3 (0 to 500 Ω | 0/4 to 20 m A)

General notes



Monitoring of the analog inputs (overrun/underrun) must be configured manually to the flexible limits (↪ Chapter 4.4.5 "Flexible Limits" on page 194).

ID	Parameter	CL	Setting range [Default]	Description
1025 1075 1125	Analog input {x}: Description	2	user-defined  1 to 16 characters  [Analog inp. {x}]	The event history will store this text message and it is also displayed on the visualization screen.  If the programmed limit value of the analog input has been reached or exceeded this text is displayed in the control unit screen.
				<b>Notes</b> This parameter may only be configured using ToolKit.
1000 1050 1100	Analog input {x}: Type	2	[Off]	The analog input is switched off.
			VDO 5 bar	The value of the analog input is interpreted with the VDO characteristics 0 to 5 bar.
			VDO 10 bar	The value of the analog input is interpreted with the VDO characteristics 0 to 10 bar.
			VDO 150 °C	The value of the analog input is interpreted with the VDO characteristics 50 to 150 °C.
			VDO 120 °C	The value of the analog input is interpreted with the VDO characteristics 40 to 120 °C.
			Pt100	The value of the analog input is interpreted with a Pt100 characteristic.
			Linear	Each analog input may be assigned to a linear characteristic curve, which can be only used for the respective defined input [T{x}] (x = 1 to 2). The minimum (0 %) and maximum (100 %) value refers to the total measuring range of the analog input (i.e. 0 to 500 Ohm or 0 to 20 mA) or the values configured as "Sender value at display min." (parameter 1039 ↪ p. 238, 1089 ↪ p. 238 or 1139 ↪ p. 238) and "Sender value at display max." (parameter 1040 ↪ p. 238, 1090 ↪ p. 238 or 1140 ↪ p. 238).
			Table A/B	The analog input is assigned to a characteristic curve which is defined over 9 points (stored in a table). Two independent tables (table A and table B) may be allocated to the analog inputs.  Note that if these tables are to be used with the analog inputs, the defined points of these tables must be programmed into the control unit.
			<b>Notes</b> For the characteristic curves of the inputs refer to ↪ Chapter 9.1.2 "VDO Inputs Characteristics" on page 556.	
1001 1051 1101	User defined min. display value	2	-32000 to 32000 [0]	The value to be displayed for the minimum of the input range must be entered here.

## Configuration

Configure Application > Inputs And Outputs > Analog Inputs

ID	Parameter	CL	Setting range [Default]	Description
	(User defined minimum display value)			<p><b>Notes</b></p> <p>This parameter is only visible if the parameter "Type" (1000 ↪ p. 237/1050 ↪ p. 237/1100 ↪ p. 237) is configured to "Linear".</p>
1002 1052 1102	<p><b>User defined max. display value</b></p> <p>(User defined maximum display value)</p>	2	-32000 to 32000 [1000]	<p>The value to be displayed for the maximum of the input range must be entered here.</p> <p><b>Notes</b></p> <p>This parameter is only visible if the parameter "Type" (1000 ↪ p. 237/1050 ↪ p. 237/1100 ↪ p. 237) is configured to "Linear".</p>
1039 1089 1139	<p><b>Sender value at display min.</b></p> <p>(Sender value at display minimum)</p>	2	0.00 to 100.00 % [0.00 %]	<p>The value of the configured input range, which shall correspond with the minimum value configured for the display, must be entered here. This specifies the lower limit of the hardware range to be measured.</p> <p><b>Example</b></p> <p>If the input range is 0 to 20 mA where 0 mA corresponds with 0 % and 20 mA corresponds with 100 %, and the value configured here is 20 %, an analog input value of 4 mA would correspond with the minimum value configured for the display.</p> <p><b>Notes</b></p> <p>This parameter is only visible if the parameter "Type" (1000 ↪ p. 237/1050 ↪ p. 237/1100 ↪ p. 237) is configured to "Linear", "Table A", or "Table B".</p>
1040 1090 1140	<p><b>Sender value at display max.</b></p> <p>(Sender value at display maximum)</p>	2	0.00 to 100.00 % [100.00 %]	<p>The value of the configured input range, which shall correspond with the maximum value configured for the display, must be entered here. This specifies the upper limit of the hardware range to be measured.</p> <p><b>Example</b></p> <p>If the input range is 0 to 500 Ohm where 0 Ohm corresponds with 0 % and 500 Ohm corresponds with 100 %, and the value configured here is 36 %, an analog input value of 180 Ohm would correspond with the maximum value configured for the display.</p> <p><b>Notes</b></p> <p>This parameter is only visible if the parameter "Type" (1000 ↪ p. 237/1050 ↪ p. 237/1100 ↪ p. 237) is configured to "Linear", "Table A", or "Table B".</p>
1020 1070 1120	<b>Sender type</b>	2	<p>[0 to 500 Ohm]</p> <p>0 to 20 mA</p>	<p>The software in the control unit may be configured for various types of sensors. The configurable ranges apply to the linear analog input.</p> <p>The measuring range of the analog input is 0 to 500 Ohm (0 Ohm = 0 %, 500 Ohm = 100 %).</p> <p>The measuring range of the analog input is 0 to 20 mA (0 mA = 0 %, 20 mA = 100 %).</p> <p><b>Notes</b></p> <p>This parameter must be configured to "0 to 500 Ohm", if parameter "Type" (1000 ↪ p. 237/1050 ↪ p. 237/1100 ↪ p. 237) is set to "VDO xx" or "Pt100".</p>

ID	Parameter	CL	Setting range [Default]	Description
1046 1096 1146	<b>Offset</b>	2	-20.0 to 20.0 Ohm	The resistive input (the "0 to 500 Ohm" analog input) may be calculated with a permanent offset to adjust for inaccuracies.
[0.0 Ohm]			If the offset feature is utilized, the value configured in this parameter will be added to/subtracted from the measured resistive value.  This has the following effect to the measured values (please note tables in <a href="#">Chapter 9.1.2 "VDO Inputs Characteristics" on page 556</a> ):	
				<p><b>Notes</b></p> <p>This parameter is only visible if the parameter "Sender type" (1020 <a href="#">p. 238/1070</a> <a href="#">p. 238/1120</a> <a href="#">p. 238</a>) is configured to "0 to 500 Ohm".</p> <p>VDO temperature and pressure senders use the ± range in different ways! Please take care for sender documentation.</p>
1041 1091 1141	<b>Sender connection type</b>	2		This parameter defines the type of the used sender.
[Two wire]			A two-pole sender is connected to the easYgen. The unit measures the sender values between the dedicated terminals.	
One wire			A single-pole sender is connected to the easYgen. The unit measures the sender values between the terminal of the analog input and the engine ground terminal.	
				<p><b>Notes</b></p> <p>This parameter is only visible if the parameter "Sender type" (1020 <a href="#">p. 238/1070</a> <a href="#">p. 238/1120</a> <a href="#">p. 238</a>) is configured to "0 to 500 Ohm".</p> <p>Refer to <a href="#">Chapter 3.3.12 "Analog Inputs (0 to 500 Ohm   0/4 to 20 mA)" on page 74</a> for wiring details.</p>
1003 1053 1103	<b>Monitoring wire break</b>	2		The respective analog input can be monitored for wire breaks.  If this protective function is triggered, the display indicates "Wb: {Text of Parameter [Description]}" (parameter 1025 <a href="#">p. 237/1075</a> <a href="#">p. 237/1125</a> <a href="#">p. 237</a> ).
[Off]			No wire break monitoring is performed.	
High			If the actual value rises over the maximum value (overshoot), this is identified as a wire break.	
Low			If the actual value falls below the minimum value (undershoot), this is identified as a wire break.	
High/Low			If the actual value rises over the maximum value (overshoot) or falls below the minimum value (undershoot), this is identified as a wire break.	

## Configuration

Configure Application > Inputs And Outputs > Analog Inputs

ID	Parameter	CL	Setting range [Default]	Description
				<p><b>Notes</b></p> <p>Monitoring of the analog inputs (overrun/underrun) must be configured manually to the flexible limits ( <a href="#">Chapter 4.4.5 "Flexible Limits" on page 194</a>).</p> <p>If the control unit detects that the measuring range for an analog input has been exceeded and an alarm is issued, the limit value monitoring of this analog input is disabled and an error message is displayed.</p> <p>The measuring range is recognized as being exceeded and an alarm is issued:</p> <ul style="list-style-type: none"> <li>■ 0 to 20 mA: Minimum value 2 mA Undershooting Maximum value 20.5 mA Overshooting</li> <li>■ 0 to 500 Ohm Minimum value 5 Ohm Undershooting (Offset = 0 Ohm) Maximum value 515 Ohm Overshooting (Offset = 0 Ohm)</li> </ul>
				<p>Depending on what was configured for the offset value (parameter 1046 <a href="#">p. 239/1096</a> <a href="#">p. 239/1146</a> <a href="#">p. 239</a>) the displayed value may be shifted.</p> <p>This may result in a broken wire being recognized early or later than the actual value being measured. (An offset of +20 Ohm will recognize a wire break at 25 ohms instead of 5 Ohm.)</p>
				A wire break is indicated in ToolKit by displaying an analog input value of 3276.6.
1004 1054 1104	<b>Wire break alarm class</b>	2		Each limit may be assigned an independent alarm class that specifies what action should be taken when the limit is surpassed.
			A/[B]	Warning alarm classes
			C/D/E/F	Shutdown alarm classes
			Control	Signal to issue a control command only
				<p><b>Notes</b></p> <p>This parameter is only visible wire break monitoring (parameter 1003 <a href="#">p. 239/1053</a> <a href="#">p. 239/1103</a> <a href="#">p. 239</a>) is not set to "Off"</p> <p>For additional information refer to <a href="#">Chapter 9.5.1 "Alarm Classes" on page 733</a>.</p>
1005 1055 1105	<b>Self acknowledge wire break</b>	2	Yes	The control automatically clears the alarm if the fault condition is no longer detected.
			[No]	The control does not automatically reset the alarm when the fault condition is no longer detected. The alarm must be acknowledged and reset by manually pressing the appropriate buttons or by activating the LogicsManager output "External acknowledgement" (via a discrete input or via an interface).
				<p><b>Notes</b></p> <p>This parameter is only visible wire break monitoring (parameter 1003 <a href="#">p. 239/1053</a> <a href="#">p. 239/1103</a> <a href="#">p. 239</a>) is not set to "Off"</p>



ID	Parameter	CL	Setting range [Default]	Description
10113 10114 10116	<b>Filter time constant</b>	2	Off, 1 to 5	A low pass filter may be used to reduce the fluctuation of an analog input reading. The filter time constant assesses the average of the signal according to the following formula:  <ul style="list-style-type: none"> <li>■ <math>\text{Cut-off-frequency} = 1 / (20 \text{ ms} * 2 * \pi * 2^N \cdot 1)</math></li> </ul> whereby "N" is the filter time constant and the cut-off-frequency is defined as usual with 63% ( $e^{-1}$ ).
Off			The analog input is displayed without filtering.	
1			Cut-off-frequency = 7.96 Hz (filter time constant = 0.02 s)	
2			Cut-off-frequency = 3.98 Hz (filter time constant = 0.04 s)	
[3]			Cut-off-frequency = 1.99 Hz (filter time constant = 0.08 s)	
4			Cut-off-frequency = 0.99 Hz (filter time constant = 0.16 s)	
5			Cut-off-frequency = 0.50 Hz (filter time constant = 0.32 s)	
3632 3634 3636	<b>Bargraph minimum</b>		-32000 to 32000 [0]	The start value for the bar graph display of the analog input is defined here. The value must be entered according to the display format, which refers to the analog input type (parameter 1000 ↪ p. 237).
		2		<b>Notes</b>  This parameter is only effective if parameter 1000 ↪ p. 237 is configured to "Linear" or "Table A/B".
3633 3635 3637	<b>Bargraph maximum</b>		-32000 to 32000 [1000]	The end value for the bar graph display of the analog input is defined here. The value must be entered according to the display format, which refers to the analog input type (parameter 1000 ↪ p. 237).
		2		<b>Notes</b>  This parameter is only effective if parameter 1000 ↪ p. 237 is configured to "Linear" or "Table A/B".
1035 1085 1135	<b>Value format</b>	2	1 to 8 character text [000000]	To display the measuring value of the analog input for the analog input types linear as well as Table A and Table B (parameter 1000 ↪ p. 237) correctly this parameter is to be used to define the format.  The zeros in the numeric display are used for the measuring values and are configurable. The placeholders for the digits may have symbols (i.e. commas).

### Value Format - Examples

#### Examples for the value format

- Fuel level
  - value at 0%: 0
  - value at 100%: 1000
  - desired display: up to 1,000 mm
  - this parameter: 0,000 mm
- Angle
  - value at 0%: 1799
  - value at 100%: 1800
  - desired display: -179.9° to 180.0°
  - this parameter: 0000.0°
- Pressure
  - value at 0%: 0
  - value at 100%: 100
  - desired display: up to 10.0 bar
  - this parameter: 00.0 bar



*If a sign to denote a negative measured value (i.e. – 10) is required, then the first "0" of the numeric display is utilized for this symbol.*

*This parameter may only be configured using ToolKit.*

### General notes

This parameter only applies to the linear and the user defined "Table A" and "Table B" (parameter 1000 ↗ p. 237) analog input types.

The displayed value should be configured with the same number of digits as the desired value to be measured.

The measured value will be displayed from right to left. If the measured value is larger than the number of digits in the display, only a portion of the measured value will be shown.

An example of this would be a display of three digits is configured when four digits will be needed. Instead of the number "1234" being displayed only "234" will be shown.

If the analog input type (parameter 1000 ↗ p. 237) is configured to VDO or Pt100, the following formats apply:

- VDO 5 bar display in 0.01 bar  
example: 5.0 bar > ToolKit display: 500
- VDO 10 bar display in 0.01 bar  
example: 6.6 bar > ToolKit display: 660
- VDO 120 °C display in °C  
example: 69 °C > ToolKit display: 69
- VDO 150 °C display in °C  
example: 73 °C > ToolKit display: 73
- Pt100 display in °C  
example: 103 °C > ToolKit display: 103

### 4.5.2.2 External Analog Inputs

#### General notes

External analog inputs are available at:

-  package 2 only.

Configuration of these external analog inputs is performed similarly to the internal analog inputs.

If an external expansion board (Phoenix Contact) is connected to the easYgen via the CAN bus, it is possible to use 16 additional analog inputs.

- Refer to  *Table on page 243* for the parameter IDs of the parameters for external analog inputs 1 through 16.



*Please note that the available options for the parameters "Type" and "Sender type" differ from the internal analog inputs.*

*The parameters "Offset" and "Monitoring wire break" are not available for the external analog inputs.*

- *Refer to the Parameter List for details.*



*A wire break or sender failure is indicated by a dedicated value sent via the CAN bus (  Chapter 4.6.1 "CAN Interface 1" on page 352).*



*For an example for the configuration of external analog inputs refer to  Chapter 6.4.12.1 "Configure External Inputs/Outputs (Phoenix)" on page 462.*



*Monitoring of the analog inputs (overrun/underrun) must be configured manually to the flexible limits (  Chapter 4.4.5 "Flexible Limits" on page 194).*

### External analog inputs - parameter IDs

Parameter external	AI 1	AI 2	AI 3	AI 4	AI 5	AI 6	AI 7	AI 8
Description	16203	16213	16223	16233	16243	16253	16263	16273
Type1	5851	5864	5871	5881	5903	5916	5929	5942
User defined min display value	5852	5865	5872	5882	5904	5917	5930	5943
User defined max display value	5853	5866	5873	5883	5905	5918	5931	5944
Sender value at display min.	5857	5870	5877	5887	5909	5922	5935	5948

## Configuration

Configure Application > Inputs And Outputs > External Analog Inputs

Parameter external	AI 1	AI 2	AI 3	AI 4	AI 5	AI 6	AI 7	AI 8
Sender value at display max.	5858	5871	5878	5888	5910	5923	5936	5949
Sender type	5856	5869	5876	5886	5908	5921	5934	5947
Sender connection type	5859	5872	5859	5889	5911	5924	5937	5950
Wire break alarm class	5854	5867	5874	5884	5906	5919	5932	5945
Self acknowledge wire break	5855	5868	5875	5885	5907	5920	5933	5946
Filter time constant	5863	5876	5883	5893	5915	5928	5941	5954
Bargraph minimum	5861	5874	5881	5891	5913	5926	5939	5952
Bargraph maximum	5862	5875	5882	5892	5914	5927	5940	5953
Value format	16204	16214	16224	16234	16244	16254	16264	16274

Parameter external	AI 9	AI 10	AI 11	AI 12	AI 13	AI 14	AI 15	AI 16
Description	16283	16293	16303	16313	16323	16333	16343	16353
Type	5955	5968	5981	6930	6943	6956	6969	6982
User defined min display value	5956	5969	5982	6931	6944	6957	6970	6983
User defined max display value	5957	5970	5983	6932	6945	6958	6971	6984
Sender value at display min.	5961	5974	5987	6936	6949	6962	6975	6988
Sender value at display max.	5962	5975	5988	6937	6950	6963	6976	6989
Sender type	5960	5973	5986	6935	6948	6961	6974	6987
Sender connection type	5963	5976	5989	6938	6951	6964	6977	6990
Wire break alarm class	5958	5971	5984	6933	6946	6959	6972	6985
Self acknowledge wire break	5959	5972	5985	6934	6947	6960	6973	6986

Parameter external	AI 9	AI 10	AI 11	AI 12	AI 13	AI 14	AI 15	AI 16
Filter time constant	5967	5980	5993	6942	6955	6968	6981	6994
Bargraph minimum	5965	5978	5991	6940	6953	6966	6979	6992
Bargraph maximum	5966	5979	5992	6941	6954	6967	6980	6993
Value format	16284	16294	16304	16314	16324	16334	16344	16354

**External analog inputs – example configuration analog input 1**

Setting range - parameter type (parameter 5851)	Setting range - sender type (parameter 5856)	Setting range - sender connection type (parameter 5859)
Off	0 - 10 V	Two wire
Linear	±10 V	Three wire
Table A	0 - 20 mA	
Table B	±20 mA	
TC Type K	4 - 20 mA	
TC Type J	0 - 400 Ohms	
TC Type E	0 - 4000 Ohms	
TC Type R	Thermocouple	
TC Type S	R0=100	
TC Type T	R0=10	
TC Type B	R0=20	
TC Type N	R0=30	
TC Type U	R0=50	
TC Type L	R0=120	
TC Type C	R0=150	
TC Type W	R0=200	
TC Type HK	R0=240	
Pt DIN(R0)	R0=300	
Pt SAMA(R0)	R0=400	
Ni DIN(R0)	R0=500	
Ni SAMA(R0)	R0=1000	
Cu10	R0=1500	
Cu50	R0=2000	
Cu53	R0=3000	
Ni 1000(Landis)		
Ni 500(Viessm.)		

Setting range - parameter type (parameter 5851)	Setting range - sender type (parameter 5856)	Setting range - sender connection type (parameter 5859)
KTY 81-110		
KTY 84		

### 4.5.3 Discrete Inputs

#### General notes

Discrete inputs may be configured to normally open (N.O.) or normally closed (N.C.) states.

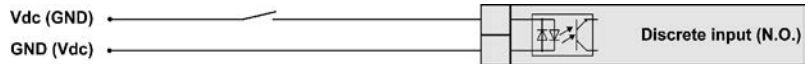

Fig. 89: Discrete inputs - alarm/control inputs - operation logic (state N.O.)

In the state N.O.:

- No potential is present during normal operation.
- If an alarm is issued or control operation is performed, the input is energized.

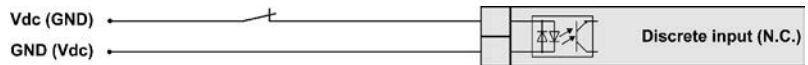

Fig. 90: Discrete inputs - alarm/control inputs - operation logic (state N.C.)

In the state N.C.:

- A potential is continuously present during normal operation
- If an alarm is issued or control operation is performed, the input is de-energized.



All reply messages from breakers are evaluated as N.C.



Alarm inputs may also be configured as control inputs and then be used as command variables in the Logics-Manager.



The discrete inputs 1 to 5 are pre-configured to various functions and differ in their default values. However, they may still be configured freely.

The discrete inputs 7 & 8 are always used for the circuit breaker replies and cannot be configured.



*If a discrete input has been configured with a shut-down alarm that has been enabled to self-acknowledge, and has been configured as engine delayed the following scenario may happen:*

- *The discrete input shuts down the engine because of its alarm class.*
- *Due to the engine stopping, all engine delayed alarms are ignored.*
- *The alarm class is acknowledged automatically.*
- *The alarm will self-acknowledge and clear the fault message that shut the engine down. This prevents the fault from being analyzed.*
- *After a short delay, the engine will restart.*
- *After the engine monitoring delay expires, the fault that originally shut down the engine will do so again. This cycle will continue to repeat until corrected.*

**Internal discrete inputs - terminal assignment**

Number	Terminal	Assignment (all application modes)
[DI 01]	67	Alarm input (LogicsManager); pre-configured for 'Emergency Stop'
[DI 02]	68	Control input (LogicsManager); pre- configured for 'Start request in AUTO'
[DI 03]	69	Alarm input (LogicsManager); pre- configured for 'Low oil pressure'
[DI 04]	70	Alarm input (LogicsManager); pre- configured for 'Coolant temperature'
[DI 05]	71	Control input (LogicsManager); pre- configured for 'External acknowledgement'
[DI 06]	72	Control input (LogicsManager); pre- configured for 'Release MCB'
[DI 07]	73	Reply MCB
[DI 08]	74	Reply GCB
[DI 09]	75	Alarm input (LogicsManager)
[DI 10]	76	Alarm input (LogicsManager)
[DI 11]	77	Alarm input (LogicsManager)
[DI 12]	78	Alarm input (LogicsManager)

## Parameter IDs



The following parameters are used to configure the discrete inputs 1 through 12. The parameter IDs refer to discrete input 1.

- Refer to [“Discrete inputs - parameter IDs”](#) on page 248 for the parameter IDs of the parameters DI 2 through DI 12(23).

	DI 1	DI 2	DI 3	DI 4	DI 5	DI 6	DI 7	DI 9	DI 10	DI 11	DI 12
Text	1400	1410	1420	1430	1440	1450	1460	1480	1488	1496	1504
Operation	1201	1221	1241	1261	1281	1301	1321	1361	1381	1206	1226
Delay	1200	1220	1240	1260	1280	1300	1320	1360	1380	1205	1225
Alarm class	1202	1222	1242	1262	1282	1302	1322	1362	1382	1207	1227
Delayed by engine speed	1203	1223	1243	1263	1283	1303	1323	1363	1383	1208	1228
Self acknowledged	1204	1224	1244	1264	1284	1304	1324	1364	1384	1209	1229

Table 37: Discrete inputs - parameter IDs

ID	Parameter	CL	Setting range [Default]	Description
1400	DI {x} Text	2	user defined (4 to 16 characters) for default see <a href="#">Table on page</a>	If the discrete input is enabled with alarm class, this text is displayed on the control unit screen. The event history will store this text message as well.
				<b>Notes</b> This parameter may only be configured using ToolKit. If the DI is used as control input with the alarm class "Control", you may enter here its function (e.g. external acknowledgement) for a better overview within the configuration.
1201	DI {x} Operation	2		The discrete inputs may be operated by an normally open (N.O.) or normally closed (N.C.) contact. The idle circuit current input can be used to monitor for a wire break. A positive or negative voltage polarity referred to the reference point of the DI may be applied.
			[N.O.]	The discrete input is analyzed as "enabled" by energizing the input (normally open).
			N.C.	The discrete input is analyzed as "enabled" by de-energizing the input (normally closed).



ID	Parameter	CL	Setting range [Default]	Description
1200	DI {x} Delay	2	0.08 to 650.00 s [0.20 s]	<p>A delay time in seconds can be assigned to each alarm or control input.</p> <p>The discrete input must be enabled without interruption for the delay time before the unit reacts.</p> <p>If the discrete input is used within the LogicsManager this delay is taken into account as well.</p>
1202	DI {x} Alarm class	2		<p>An alarm class may be assigned to the discrete input.</p> <p>The alarm class is executed when the discrete input is enabled.</p>
			A/[B]	Warning alarm classes
			C/D/E/F	Shutdown alarm classes
			Control	<p>Signal to issue a control command only.</p> <p>If "control" has been configured, there will be no entry in the event history and a function out of the LogicsManager ( <a href="#">↪ Chapter 9.4.1 "LogicsManager Overview" on page 689</a>) can be assigned to the discrete input.</p>
1203	DI {x} Delayed by engine speed	2	Yes	Monitoring for fault conditions is not performed until engine delayed monitoring is enabled. The engine monitoring delay time (parameter 3315 <a href="#">↪ p. 270</a> ) must expire prior to fault monitoring being enabled for parameters assigned this delay.
			[No]	Monitoring for this fault condition is continuously enabled regardless of engine speed.
1204	DI {x} Self acknowledge	2	Yes	The control automatically clears the alarm if the fault condition is no longer detected.
			[No]	<p>The control does not automatically reset the alarm when the fault condition is no longer detected.</p> <p>The alarm must be acknowledged and reset by manually pressing the appropriate buttons or by activating the LogicsManager output "External acknowledgement" (via a discrete input or via an interface).</p>
				<p><b>Notes</b></p> <p>If the DI is configured with the alarm class "Control", self acknowledgement is always active.</p>

#### 4.5.4 External Discrete Inputs

If a Woodward IKD 1 or other external expansion board (Phoenix Contact) is connected to the easYgen via the CAN bus, it is possible to use 32 additional discrete inputs.



- The configuration of these external DIs is performed similarly to the internal DIs ( ↪ Chapter 4.5.3 “Discrete Inputs” on page 246).
- Refer to ↪ “External discrete inputs - parameter IDs 1..8” on page 250 for the parameter IDs of the parameters for external DIs 1 through 32.

External	DI 1	DI 2	DI 3	DI 4	DI 5	DI 6	DI 7	DI 8
Text	16200	16210	16220	16230	16240	16250	16260	16270
Operation	16001	16011	16021	16031	16041	16051	16061	16071
Delay	16000	16010	16020	16030	16040	16050	16060	16070
Alarm class	16002	16012	16022	16032	16042	16052	16062	16072
Delayed by engine speed	16003	16013	16023	16033	16043	16053	16063	16073
Self acknowledged	16004	16014	16024	16034	16044	16054	16064	16074

Table 38: External discrete inputs - parameter IDs 1..8

External	DI 9	DI 10	DI 11	DI 12	DI 13	DI 14	DI 15	DI 16
Text	16280	16290	16300	16310	16320	16330	16340	16350
Operation	16081	16091	16101	16111	16121	16131	16141	16151
Delay	16080	16090	16100	16110	16120	16130	16140	16150
Alarm class	16082	16092	16102	16112	16122	16132	16142	16152
Delayed by engine speed	16083	16093	16103	16113	16123	16133	16143	16153
Self acknowledged	16084	16094	16104	16114	16124	16134	16144	16154

Table 39: External discrete inputs - parameter IDs 9..16

External	DI 17	DI 18	DI 19	DI 20	DI 21	DI 22	DI 23	DI 24
P2 only								
Text	16201	16211	16221	16231	16241	16251	16261	16271
Operation	16006	16016	16026	16036	16046	16056	16066	16076
Delay	16005	16015	16025	16035	16045	16055	16065	16075
Alarm class	16007	16017	16027	16037	16047	16057	16067	16077
Delayed by engine speed	16008	16018	16028	16038	16048	16058	16068	16078
Self acknowledged	16009	16019	16029	16039	16049	16059	16069	16079

Table 40: External discrete inputs - parameter IDs 17..24

External	DI 25	DI 26	DI 27	DI 28	DI 29	DI 30	DI 31	DI 32
 P2 only								
Text	16281	16291	16301	16311	16321	16331	16341	16351
Operation	16086	16096	16106	16116	16126	16136	16146	16156
Delay	16085	16095	16105	16115	16125	16135	16145	16155
Alarm class	16087	16097	16107	16117	16127	16137	16147	16157
Delayed by engine speed	16088	16098	16108	16118	16128	16138	16148	16158
Self acknowledged	16089	16099	16109	16119	16129	16139	16149	16159

Table 41: External discrete inputs - parameter IDs 25..32

### 4.5.5 Discrete Outputs (LogicsManager)

The discrete outputs are controlled via the LogicsManager.



For information on the LogicsManager and its default settings see [Chapter 9.4.1 "LogicsManager Overview" on page 689](#).

Some outputs are assigned a function according to the application mode (see following table).

Relay		Application mode			
No.	Terminal	None <b>A01</b>	GCB open <b>A02</b>	GCB open/close <b>A03</b>	GCB/MCB open/close <b>A04</b>
[R 01]	41/42	LogicsManager; pre-assigned with 'Ready for operation OFF' <b>CAUTION!</b> Only relay [R 01] has an inverse logic. The relay opens (all other relays close), if the logical output of the LogicsManager becomes TRUE.			
[R 02]	43/46	LogicsManager; pre-assigned with 'Centralized alarm (horn)'			
[R 03]	44/46	LogicsManager; pre-assigned with 'Starter'			
[R 04]	45/46	LogicsManager; pre-assigned with 'Diesel: Fuel solenoid, Gas: Gas valve'			
[R 05]	47/48	LogicsManager; pre-assigned with 'Preglow'			
[R 06]	49/50	LogicsManager		Command: close GCB	
[R 07]	51/52	LogicsManager		Command: open GCB	
[R 08]	53/54	LogicsManager			Command: close MCB
[R 09]	55/56	LogicsManager			Command: open MCB
[R 10]	57/60	LogicsManager; pre-assigned with 'Auxiliary services'			

Relay		Application mode			
No.	Terminal	None <b>A01</b>	GCB open <b>A02</b>	GCB open/close <b>A03</b>	GCB/MCB open/close <b>A04</b>
[R 11]	58/60	LogicsManager; pre-assigned with 'Alarm class A, B active'			
[R 12]	59/60	LogicsManager; pre-assigned with 'Alarm class C, D, E, F active'			

Table 42: Internal relay outputs - assignment



### CAUTION!

#### Uncontrolled operation due to faulty configuration

The discrete output "Ready for operation OFF" must be wired in series with an emergency stop function.

This means that it must be ensured that the generator circuit breaker is opened and the engine is stopped if this discrete output is de-energized.

If the availability of the plant is important, this fault must be signaled independently from the unit.

ID	Parameter	CL	Setting range [Default]	Description
12580	<b>Ready for op. Off</b>  (Ready for operation OFF)	2	Determined by LogicsManager	The "Ready for operation OFF" relay is energized by default if the power supply exceeds 8 V.  Once the conditions of the LogicsManager have been fulfilled, the relay will be de-energized. This LogicsManager output may be configured with additional conditions, which may signal a PLC an "out of operation" condition by de-energizing the relay on terminals 41/42, like "shutdown alarm" or no "AUTO mode" present.
				<b>Notes</b>  For information on the LogicsManager and its default settings see <a href="#">Chapter 9.4.1 "LogicsManager Overview" on page 689.</a>
12110	<b>Relay {x}</b>	2	Determined by LogicsManager	Once the conditions of the LogicsManager have been fulfilled, the relay will be energized.
				<b>Notes</b>  For information on the LogicsManager and its default settings see <a href="#">Chapter 9.4.1 "LogicsManager Overview" on page 689.</a>

**Parameter IDs**



*The parameter IDs above refers to relay 2.*

- Refer to “Discrete outputs - relay parameter IDs” on page 253 for the parameter IDs of the parameters for relay 3 to relay 12.

	R 1	R 2	R 3	R 4	R 5	R 6	R 7	R 8	R 9	R 10	R 11	R 12
Parameter ID	12580	12110	12310	12320	12130	12140	12150	12160	12170	12180	12560	12590

*Table 43: Discrete outputs - relay parameter IDs*

**4.5.6 External Discrete Outputs**

If a Woodward IKD 1 or other external expansion board (Phoenix Contact) is connected to the easYgen via the CAN bus, it is possible to use 32 additional discrete outputs.



The configuration of these external DOs is performed in a similar way like for the internal DOs.

Refer to “External discrete outputs - parameter IDs (1 to 8)” on page 254 for the parameter IDs of the parameters for external discrete outputs 1 through 32.

	DO 1	DO 2	DO 3	DO 4	DO 5	DO 6	DO 7	DO 8
Parameter ID	12330	12340	12350	12360	12370	12380	12390	12400

Table 44: External discrete outputs - parameter IDs (1 to 8)

	DO 9	DO 10	DO 11	DO 12	DO 13	DO 14	DO 15	DO 16
Parameter ID	12410	12420	12430	12440	12450	12460	12470	12480

Table 45: External discrete outputs - parameter IDs (9 to 16)

P2 only	DO 17	DO 18	DO 19	DO 20	DO 21	DO 22	DO 23	DO 24
Parameter ID	12331	12332	12333	12334	12335	12336	12337	12338

Table 46: External discrete outputs - parameter IDs (17 to 24)

P2 only	DO 25	DO 26	DO 27	DO 28	DO 29	DO 30	DO 31	DO 32
Parameter ID	12339	12341	12342	12343	12344	12345	12346	12347

Table 47: External discrete outputs - parameter IDs (25 to 32)

## 4.5.7 Analog Outputs

### 4.5.7.1 Analog Outputs 1 and 2

The analog outputs 1 and 2 may either be configured as analog or PWM outputs. The analog outputs are prepared for speed and voltage bias signal for a speed controller and voltage regulator with an output signal of 0 to 20 mA / 0 to 10 V by default.

- The following table shows the default values for the analog outputs 1 and 2 as well as two configuration examples.
- Example 1 is for a generator active power output with a range of -20 kW to 220 kW via a 4 to 20 mA signal (generator rated power = 200 kW).
- Example 2 is for a speed bias output via a PWM signal.

	ID	Analog output 1 default values	ID	Analog output 2 default values	Example 1	Example 2
Data source	5200	00.03 Speed bias	5214	00.02 Voltage bias	01.24 Gen. total power	00.03 Speed bias
Source value at minimal output	5204	0	5218	0	-1000 (-20 kW)	0
Source value at maximal output	5206	10000	5220	10000	11000 (220 kW)	10000
Filter time constant	5203	Off	5217	Off	3	Off
Selected hardware type <small>(For details refer to <a href="#">“Analog outputs - signal type selection” on page 257</a>)</small>	5201	0-20mA / 0-10V	5215	0-20mA / 0-10V	User defined	User defined
User defined min. output value	5208	---	5222	---	20.00 % (4 mA)	0.00 %
User defined max. output value	5209	---	5223	---	100.00 % (20 mA)	100.00 %
PWM signal	5202	Off	5216	Off	Off	On
PWM output value	5210	---	5224	---	---	6 V

General notes



To get the standard PWM signal it is necessary to set parameter 5201 [p. 256](#) (Selected hardware type) to "user defined". If this parameter is configured to "user defined", the range is limited by parameters 5208 [p. 257](#) (User defined min. output value) and 5209 [p. 257](#) (User defined max. output value).

Parameters 5208 [p. 257](#) and 5209 [p. 257](#) don't have a meaning unless parameter 5201 [p. 256](#) is set to "user defined".

ID	Parameter	CL	Setting range [Default]	Description
5200 5214	Data source	2	Determined by Analog Manager AO1: [00.03 Speed bias] AO2: [00.02 Voltage bias]	The data source may be selected from the available data sources.  <b>Notes</b> Refer to <a href="#">Chapter 9.3.1 "Data Sources" on page 671</a> for a list of all data sources.

## Configuration

Configure Application > Analog Outputs > Analog Outputs 1 and 2

ID	Parameter	CL	Setting range [Default]	Description
5204 5218	Source value at minimal output	2	-32000 to 32000 [0]	<p>The value from the data source must exceed the value configured here to raise the output signal above 0 %. Negative percentage values may be used to change the sign, e.g. for power.</p> <p>The entry format of the value depends on the selected data source.</p> <p><b>Notes</b></p> <p>If the monitored analog value has a reference value, the threshold is expressed as a percentage of this reference value (-320.00 % to 320.00 %).</p> <p>If an analog input is monitored, the threshold refers to the display value format ( <a href="#">↪ Chapter 9.3.2.16 "Display Value Format" on page 688</a>).</p>
5206 5220			Source value at maximal output	-32000 to 32000 [10000]
5203 5217	Filter time constant	2	Off, 1 to 7	<p>A filter time constant may be used to reduce the fluctuation of an analog output value. This filter time constant assesses the average of the signal according to the following formula:</p> <p>■ Cut-off-frequency =  <math display="block">1 / (2 * \pi * \text{Filter time constant})</math></p>
[Off]			The analog output is displayed without filtering.	
1			Cut-off-frequency = 3.98 Hz (filter time constant = 0.04 s)	
2			Cut-off-frequency = 1.98 Hz (filter time constant = 0.08 s)	
3			Cut-off-frequency = 0.99 Hz (filter time constant = 0.16 s)	
4			Cut-off-frequency = 0.5 Hz (filter time constant = 0.32 s)	
5			Cut-off-frequency = 0.25 Hz (filter time constant = 0.64 s)	
6			Cut-off-frequency = 0.12 Hz (filter time constant = 1.28 s)	
7			Cut-off-frequency = 0.06 Hz (filter time constant = 2.56 s)	
			<b>Notes</b>	The filter is not applied to the analog output display value, i.e. the end value of the analog output is displayed immediately.
5201 5215	Selected hardware type	2		This parameter is used to configure the appropriate type of analog controller signal. The range of the analog output is configured here.
Off			No analog output signal will be issued.	
user defined [0-20mA / 0-10V]			A maximum range of +/-20 mA / +/-10 V may be limited using the parameters 5208 <a href="#">↪ p. 257</a> and 5209 <a href="#">↪ p. 257</a> to obtain a user defined range.	
			<b>Notes</b>	For a list of available signal ranges refer to <a href="#">↪ "Analog outputs - signal type selection" on page 257</a>



ID	Parameter	CL	Setting range [Default]	Description
5208 5222	<b>User defined min. output value</b>  (User defined minimum output value)	2	0.00 to 100.00 %  [0.00 %]	The minimum output value, which shall correspond with the minimum value of the output range, must be entered here.  <b>Notes</b> This parameter is only active, if parameter 5201 ↪ p. 256/5215 ↪ p. 256 is set to "user defined".  <b>Example</b> If the value configured here is 25 %, the maximum output range of +/-20 mA / +/-10 V has a lower limit of -10 mA / -5 V.
5209 5223	<b>User defined max. output value</b>  (User defined maximum output value)	2	0.00 to 100.00 %  [100.00 %]	The maximum output value, which shall correspond with the maximum value of the output range, must be entered here.  <b>Notes</b> This parameter is only active, if parameter 5201 ↪ p. 256/5215 ↪ p. 256 is set to "user defined".  <b>Example</b> If the value configured here is 75 %, the maximum output range of +/-20 mA / +/-10 V has an upper limit of 10 mA / 5 V.
5202 5216	<b>PWM signal</b>	2	On  [Off]	A PWM signal will be output on the respective analog output.  An analog signal will be output on the respective analog output.  <b>Notes</b> The amplitude of the PWM signal to be utilized is configured in "PWM output level" (parameter 5210 ↪ p. 257).  If a PWM signal is used, a jumper must be installed ( ↪ Chapter 3.3.2 "Wiring Diagram" on page 43).  The PWM signal will also be limited by parameter 5201 ↪ p. 256/5215 ↪ p. 256 or parameters 5208 ↪ p. 257/5222 ↪ p. 257 and 5209 ↪ p. 257/5223 ↪ p. 257 if parameter 5201 ↪ p. 256/5215 ↪ p. 256 is user defined.
5210 5224	<b>PWM output level</b>	2	0.00 to 10.00 V  [10.00 V]	If PWM has been enabled in parameter 5203 ↪ p. 256/5217 ↪ p. 256 the level of the PWM signal may be adjusted here.

**Setting ranges**

Type	Setting in parameter 5201/5215	Jumper necessary	Range	Lower level	Upper level
Current	+/-20mA (+/-10V)	no	+/-20mA	-20 mA	+20 mA
	+/-10mA (+/-5V)		+/-10mA	-10 mA	+20 mA
	0 to 10mA (0 to 5V)		0-10mA	0 mA	10 mA
	0 to 20mA (0 to 10V)		0-20mA	0 mA	20 mA
	4 to 20mA		4-20mA	4 mA	20 mA
	10 to 0mA (5 to 0V)		10-0mA	10 mA	0 mA
	20 to 0mA (10 to 0V)		20-0mA	20 mA	0 mA

Type	Setting in parameter 5201/5215	Jumper necessary	Range	Lower level	Upper level
	20 to 4mA		20-4mA	20 mA	4 mA
	User defined				
Voltage	+/-20mA (+/-10V)	yes	+/-10V	-10 Vdc	+10 Vdc
	+/-10mA (+/-5V)		+/-5V	-5 Vdc	+5 Vdc
	+/-3V		+/-3V	-3 Vdc	+3 Vdc
	+/-2.5V		+/-2.5V	-2.5Vdc	+2.5 Vdc
	+/-1V		+/-1V	-1 Vdc	+1 Vdc
	0 to 10mA (0 to 5V)		0 to 5V	0 Vdc	5 Vdc
	0.5V to 4.5V		0.5 to 4,5V	0.5 Vdc	4.5 Vdc
	0 to 20mA (0 to 10V)		0 to 10V	0 Vdc	10 Vdc
	10 to 0mA (5 to 0V)		5 to 0V	5 Vdc	0 Vdc
	4.5V to 0.5V		4.5 to 0,5V	4.5 Vdc	0.5 Vdc
	20 to 0mA (10 to 0V)		10 to 0V	10 Vdc	0 Vdc
	User defined				

Table 48: Analog outputs - signal type selection

### 4.5.8 External Analog Outputs

External analog outputs are available at:

-  package 2 only.

If an external expansion board (Phoenix Contact) is connected to the easYgen via the CAN bus, it is possible to use 4 additional analog outputs.



*The configuration of these external analog outputs is performed similarly to the internal analog outputs.*

*Refer to  “External analog outputs - parameter IDs” on page 258 for the parameter IDs of the parameters for external analog outputs 1 through 4.*

*Please note that the available options for the Selected hardware type are limited. Refer to the Parameter List for details.*

Parameter	Ext. AO 1	Ext. AO 2	Ext. AO 3	Ext. AO 4
Data source	10237	10247	10257	10267
Source value at minimal output	10240	10250	10260	10270

Parameter	Ext. AO 1	Ext. AO 2	Ext. AO 3	Ext. AO 4
Source value at maximal output	10241	10251	10261	10271
Filter time constant	10239	10249	10259	10269
Selected hardware type	10238	10248	10258	10268
User defined min. output value	10242	10252	10262	10272
User defined max. output value	10243	10253	10263	10273

*Table 49: External analog outputs - parameter IDs*

## 4.5.9 Engine

### 4.5.9.1 Engine Type

ID	Parameter	CL	Setting range [Default]	Description
3321	Start/Stop mode logic	2		Diesel or gas engine start/stop logic must be selected.
			[Diesel]	<p><b>Start sequence</b></p> <p>The relay "Preglow" will be energized for the preheating time period ("Preglow" is displayed). Following preheating, the fuel solenoid is first energized and then the starter is engaged ("Start" is displayed).</p> <p>When the configured firing speed is exceeded, the starter is disengaged and the fuel solenoid remains energized via the firing speed. "Ramp to rated" is displayed until the engine monitoring delay timer expires and the start sequence has finished.</p> <p>If the engine fails to start, a start pause is initiated ("Start - Pause" is displayed). If the number of unsuccessful start attempts reaches the configured value, an alarm message will be issued ("Start fail" is displayed).</p> <p><b>Stop sequence</b></p> <p>After opening the GCB, the coasting time starts and the engine runs without load ("Cool down" is displayed). On termination of the coasting time, the fuel solenoid is de-energized, and the engine is stopped ("Stop engine" is displayed). If the engine cannot be stopped via the fuel solenoid, the alarm message "Eng. stop malfunct." is displayed.</p> <p><b>Start/stop diagram</b></p> <p>The formula signs and indices mean:</p> <ul style="list-style-type: none"> <li>■ tPRE Auxiliary services prerun [s] (parameter 3300 ↗ p. 271)</li> <li>■ tPH Preglow time [s] (parameter 3308 ↗ p. 262)</li> <li>■ tST Starter time [s] (parameter 3306 ↗ p. 269)</li> <li>■ tSP Start pause [s] (parameter 3307 ↗ p. 270)</li> <li>■ tED Engine delayed monitoring [s] (parameter 3315 ↗ p. 270)</li> <li>■ tPOST Auxiliary services postrun [s] (parameter 3301 ↗ p. 272)</li> <li>■ tCD Cool down time [s] (parameter 3316 ↗ p. 271)</li> <li>■ tGS Generator stable time [s] (parameter 3415 ↗ p. 227)</li> </ul> <p>Refer to ↗ "Diesel engine diagrams" on page 264.</p>

ID	Parameter	CL	Setting range [Default]	Description
			Gas	<p><b>Start sequence</b></p> <p>The starter is engaged ("Turning" is displayed). Following the expiration of the firing delay time and if the engine is rotating with at least the configured "minimum speed for ignition", the ignition is switched on ("Ignition" is displayed).</p> <p>Following the expiration of the gas valve delay, the gas valve is then enabled ("Start" is displayed). If the configured firing speed is exceeded, the starter is disengaged. The gas valve and the ignition remain enabled via the firing speed. "Ramp to rated" is displayed until the engine monitoring delay timer expires and the start sequence has finished.</p> <p>If the configured "minimum speed for ignition" is not reached, a start pause is initiated ("Start - Pause" is displayed) before the next start attempt.</p> <p><b>Stop sequence</b></p> <p>After opening the GCB, the coasting time starts and the engine runs without load ("Cool down" is displayed). On termination of the coasting time, the gas valve is closed or de-energized, and the engine is stopped ("Stop engine" is displayed).</p> <p>If the engine cannot be stopped, the alarm message "Eng. stop malfunct." is displayed. If no speed is detected anymore, the ignition remains active for 5 seconds so that the remaining gas is able to combust.</p> <p><b>Start/stop diagram</b></p> <p>The formula signs and indices mean:</p> <ul style="list-style-type: none"> <li>■ tPRE Auxiliary services prerun [s] (parameter 3300 ↗ p. 271)</li> <li>■ tST Starter time [s] (parameter 3306 ↗ p. 269)</li> <li>■ tSP Start pause [s] (parameter 3307 ↗ p. 270)</li> <li>■ tID Ignition delay [s] (parameter 3310 ↗ p. 262)</li> <li>■ tGD Gas delay [s] (parameter 3311 ↗ p. 262)</li> <li>■ tED Engine delayed monitoring [s] (parameter 3315 ↗ p. 270)</li> <li>■ tPOST Auxiliary services postrun [s] (parameter 3301 ↗ p. 272)</li> <li>■ tCD Cool down time [s] (parameter 3316 ↗ p. 271)</li> <li>■ tIC Ignition coasting ("post burning") [s] (fixed to 5 seconds)</li> <li>■ tGS Generator stable time [s] (parameter 3415 ↗ p. 227)</li> </ul> <p>Refer to ↗ "Gas engine diagrams" on page 265 and ↗ "Gas engine diagrams" on page 265.</p> <p><b>CAUTION</b></p> <p>It is imperative to connect an emergency stop circuit to discrete input DI 1 to be able to perform an emergency stop by disabling the ignition in case the gas valve fails to close.</p>
			External	The start/stop sequence must be done externally.
			Off	<p>The start/stop sequence is completely disabled.</p> <p>The delayed engine monitoring is dependent from LogicsManager release engine monitoring 12999 ↗ p. 272.</p> <p>The GCB release is activated by LogicsManager start request in AUTO (parameter 12120 ↗ p. 279).</p> <p>The controllers are deactivated in operating mode STOP.</p> <p>Please refer to ↗ Chapter 6.4.14 "Start/Stop Logic Mode "Off"" on page 467 for details.</p>

## Configuration

Configure Application > Engine > Engine Type

ID	Parameter	CL	Setting range [Default]	Description
				<p><b>Notes</b></p> <p>All functions which are described here, may be assigned by the Logics-Manager to any relay that is available via the LogicsManager and not assigned to another function.</p>
3308	<b>Preglow time</b> [tPH] (Diesel engine)	2	0 to 999 s <b>[5 s]</b>	Prior to each start, the diesel engine is preheated for this time (if a "0" has been configured here the engine will be started without preglow).
				<p><b>Notes</b></p> <p>The display indicates "Preglow".</p>
3347	<b>Preglow mode</b> (Diesel engine)	2		This parameter dictates if and under what conditions a diesel engine is preheated.
			Off	The diesel engine is never preheated before a start attempt.
			<b>[Always]</b>	Before a start attempt the "Preheating" relay is always energized for the preglow time (parameter 3308 ↗ p. 262). After that a start attempt is initiated.
			Analog	A preglow sequence is initiated if the monitored analog input temperature (coolant temperature) is below the configured threshold (parameter 3309 ↗ p. 262). The preglow sequence is enabled for the configured preglow time (parameter 3308 ↗ p. 262). After that a start attempt is initiated.
3346	<b>Preglow criterion</b> (Diesel engine)	2	Determined by AnalogManager <b>[06.01]</b>	<p>The preglow criterion may be selected from the available data sources.</p> <p>Usually, a temperature measuring is selected here, which is measured via a sensor.</p>
				<p><b>Notes</b></p> <p>Refer to ↗ <i>Chapter 9.3.1 "Data Sources" on page 671</i> for a list of all data sources.</p>
3309	<b>Preglow temperature threshold</b>	2	-10 to 250 °C <b>[0 °C]</b>	This is the temperature threshold, which must be exceeded to prevent a preheating process, if parameter 3347 ↗ p. 262 has been set to "Analog".
3310	<b>Ignition delay</b> [tID] (Gas Engine)	2	1 to 999 s <b>[5 s]</b>	<p>With gas engines often a purging operation is desired before starting.</p> <p>With the engaging of the starter the ignition delay is started. The display indicates "Turning".</p> <p>If the "Minimum speed for ignition" is reached after the expiration of this time, the ignition is energized.</p>
3311	<b>Gas valve delay</b> [tGD] (Gas Engine)	2	0 to 999 s <b>[5 s]</b>	<p>By energizing the ignition relay the gas valve delay is started ("Ignition" is displayed).</p> <p>After the time set here has expired, and as long as the speed is higher than the minimum speed for ignition, the gas valve is enabled for the time configured in parameter 3306 ↗ p. 269 "Starter time" ("Start" is displayed).</p> <p>Once the ignition speed has been reached, the gas valve remains opened. If the speed falls below ignition speed, the gas valve will be closed and the "Ignition" relay is de-energized 5 seconds later.</p>
3312	<b>Minimum speed for ignition</b> (Gas Engine)	2	10 to 1,800 rpm <b>[100 rpm]</b>	After expiration of the ignition delay the number of revolutions set here must be reached, so the "Ignition" relay will be energized.

ID	Parameter	CL	Setting range [Default]	Description
4057	Pre-excitation D+	2	[On]	When the engine is starting up, an exciting current is issued.
			Off	No exciting current is issued. The input D+ can be used as analog input which can be configured freely e.g. for speed detection.

Diesel engine diagrams

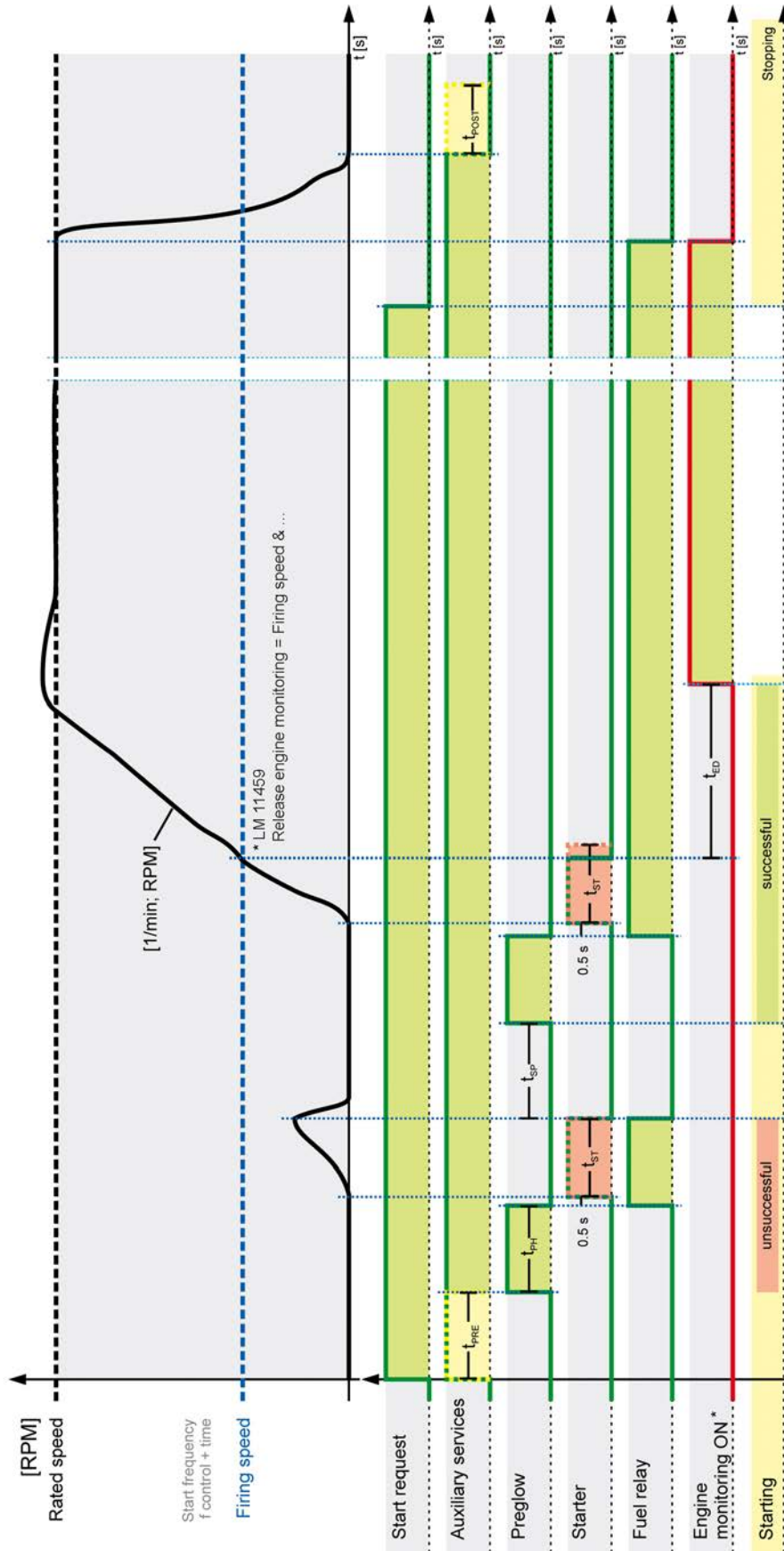

Fig. 91: Start/Stop sequence - diesel engine



Gas engine diagrams

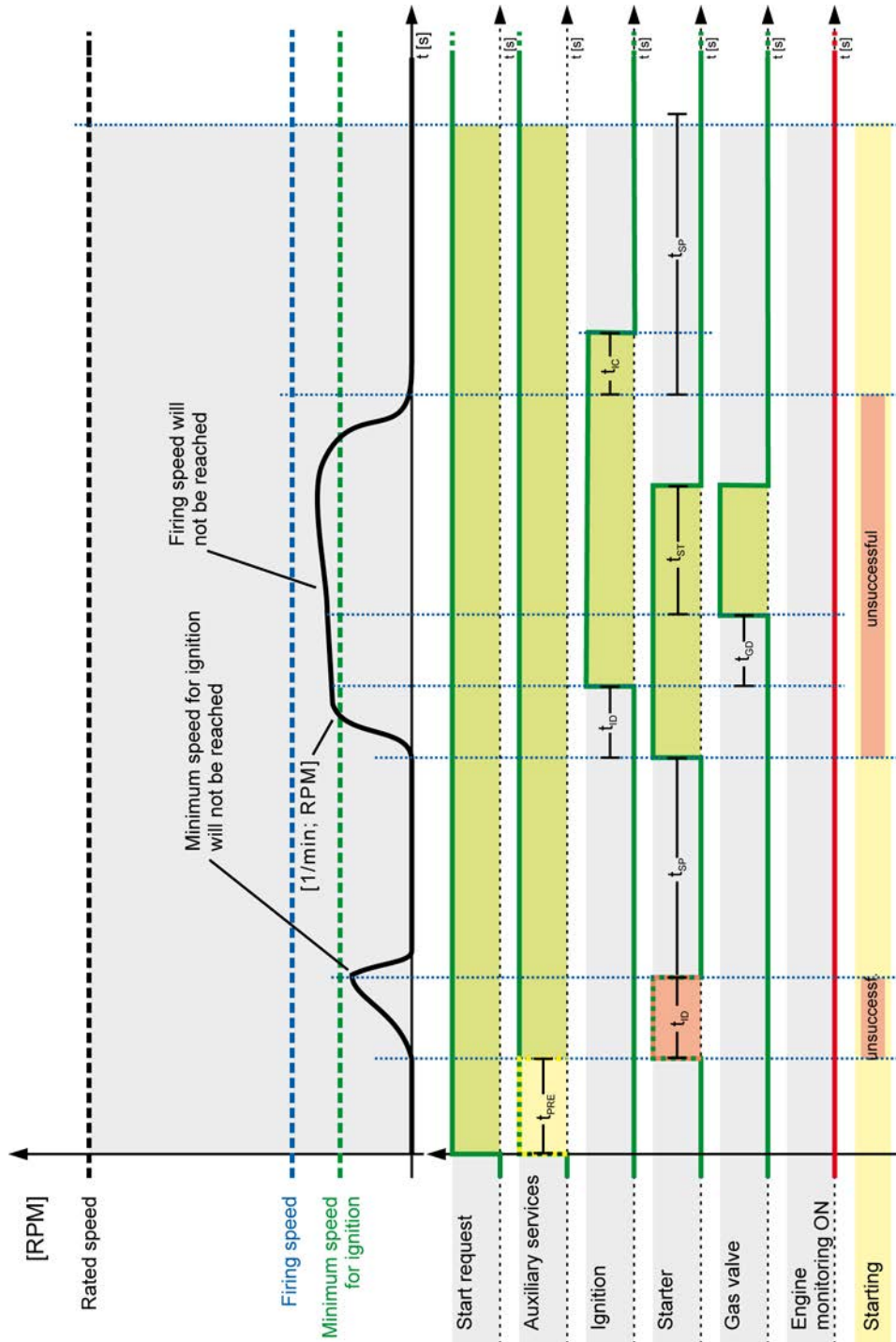

Fig. 92: Start/Stop sequence - gas engine - failure

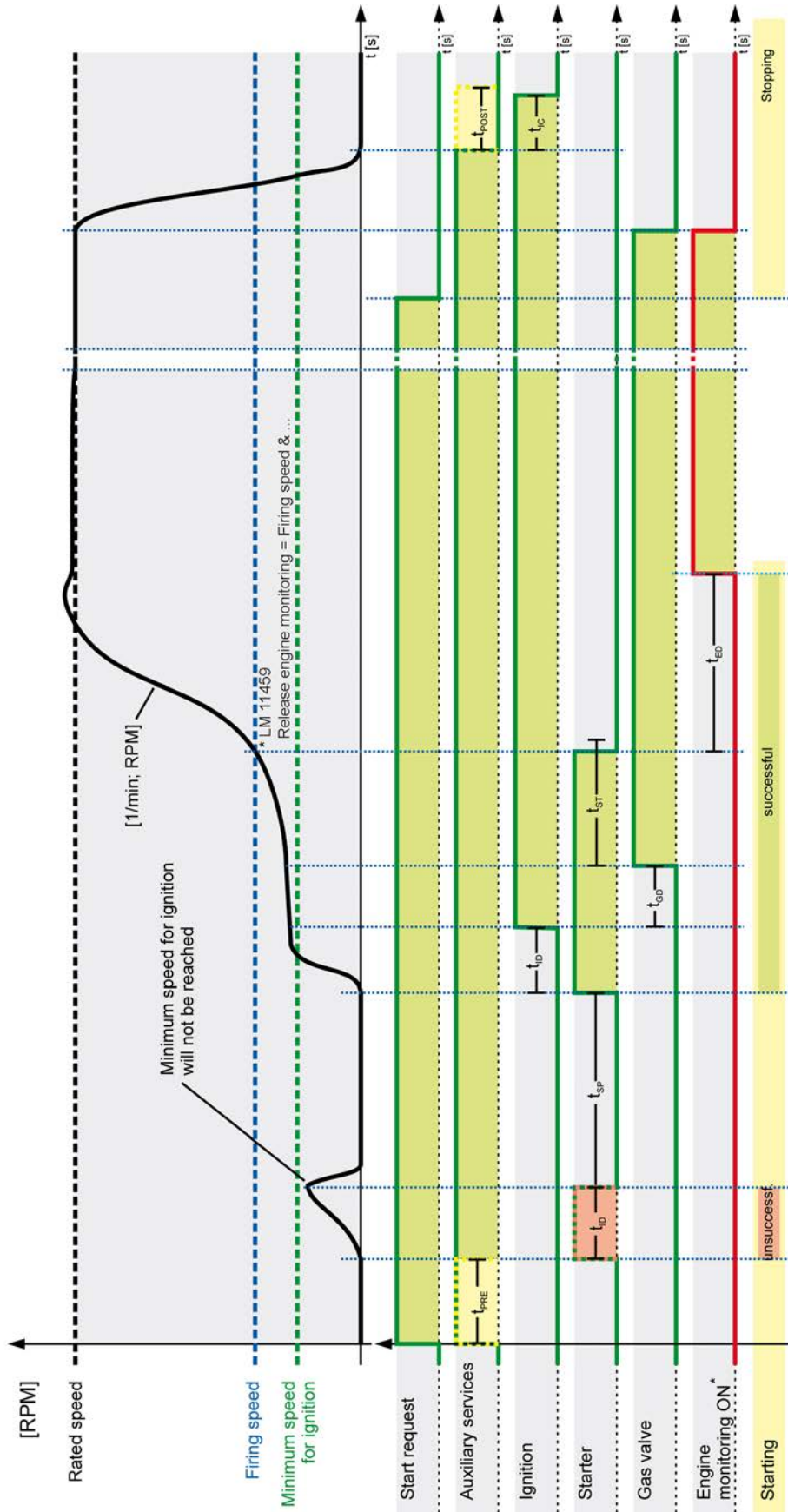

Fig. 93: Start/Stop sequence - gas engine - success

#### 4.5.9.2 Engine Start/Stop

##### Firing speed and delayed monitoring



*When the ignition speed is reached, the starter is disengaged under one of the following conditions:*

- The measurement via MPU is enabled (On):*
  - Ignition speed measured via MPU is detected or*
  - Ignition speed measured via the generator voltage is detected or*
  - Conditions for "Ignition speed" (see Logics-Manager) equal true.*
- The measurement via MPU is disabled (Off):*
  - Ignition speed measured via the generator voltage is detected or*
  - Conditions for "Ignition speed" (see Logics-Manager) equal true.*

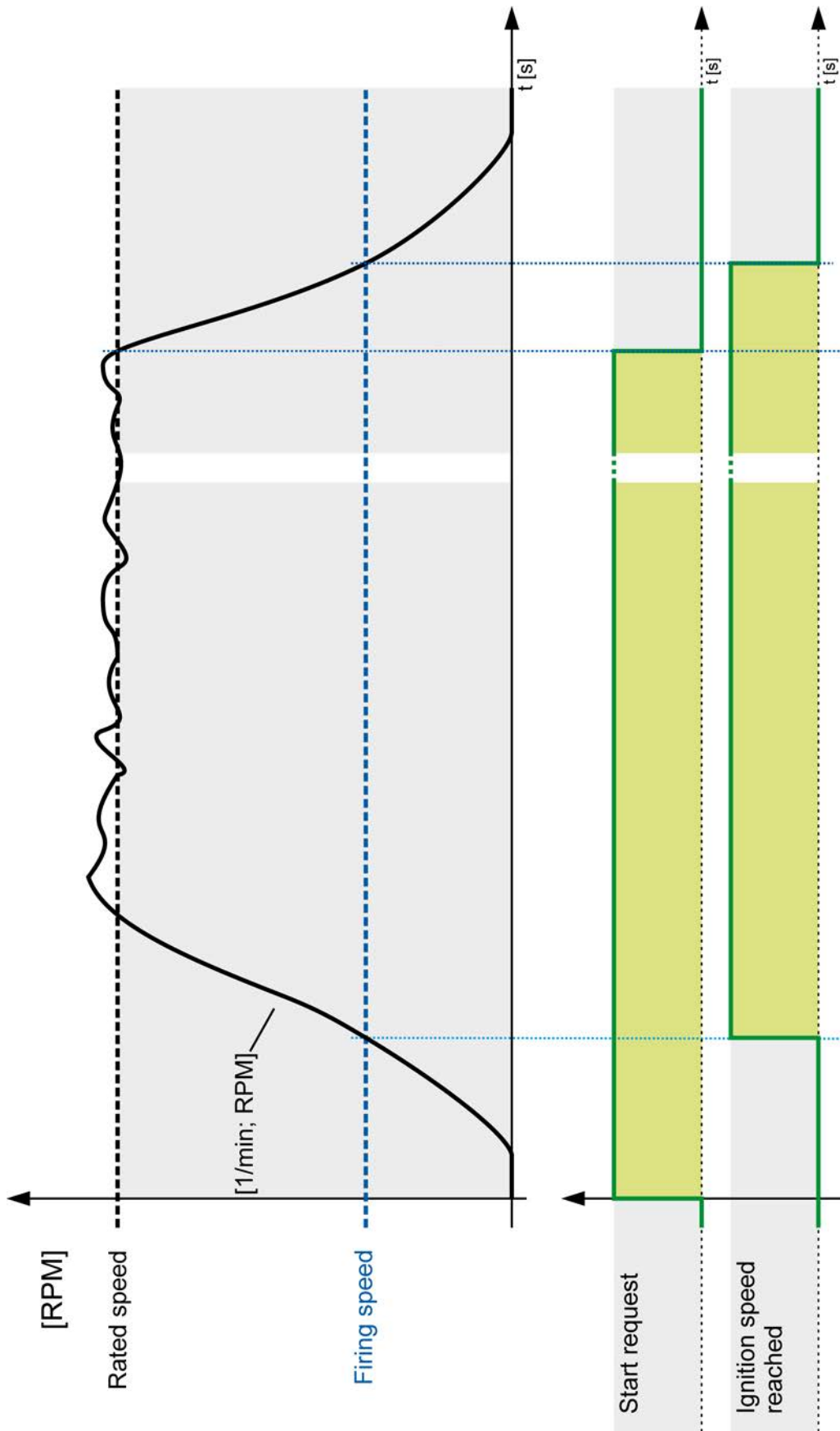

Fig. 94: Engine - firing speed

**Auxiliary operations**

The auxiliary operations start, as soon as the engine is to be started or a running engine is detected.

At the same time, the discrete output for the auxiliary services (LogicsManager 03.01) will be enabled. This discrete output remains enabled as long as speed is detected or if the controller is in the MANUAL mode.

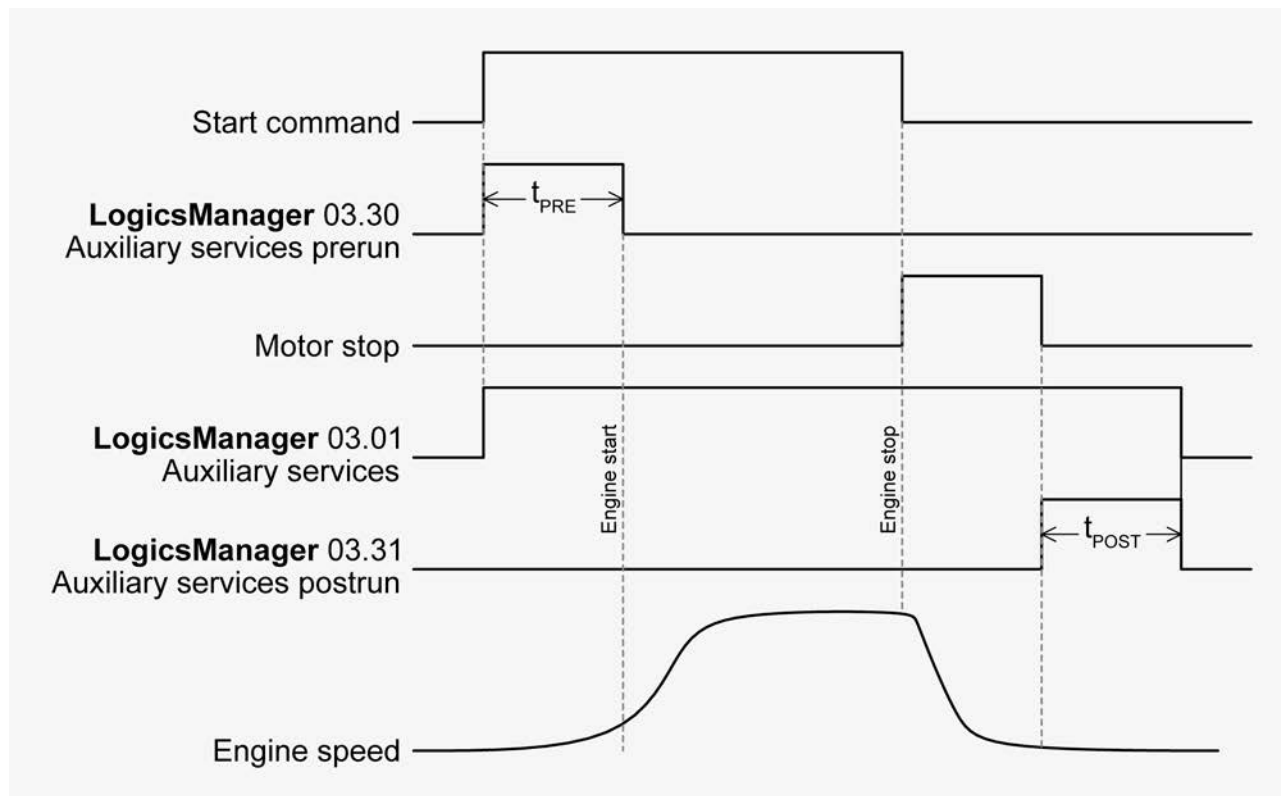

Fig. 95: : Engine - auxiliary services timing

ID	Parameter	CL	Setting range [Default]	Description
3302	Start attempts	2	1 to 20 [3]	The control will attempt to start the engine with this number of start attempts.  If the engine fails to start after the configured number of attempts, an alarm will be initiated.  An engine has been successfully started if the ignition speed reaches the configured firing speed and the delayed engine monitoring (set by release engine monitoring) has expired.
4102	Start attempts critical mode	2	1 to 20 [10]	If a critical operation mode ( <a href="#">Chapter 4.5.10 "Emergency Run" on page 276</a> ) is initiated, the engine will continue to attempt to start for the number of starts configured here.  An engine has been successfully started if the ignition speed reaches the configured firing speed and the delayed engine monitoring (set by release engine monitoring) has expired.
3306	Starter time (Maximum starter delay [tST])	2	1 to 99 s [5 s]	This is the maximum time that the starter relay will remain energized ("Start" display).  If the LogicsManager output "Ignition speed reached" = TRUE, the speed/frequency have reached firing speed, or the time has expired, the relay will be de-energized.

## Configuration

Configure Application > Engine > Engine Start/Stop

ID	Parameter	CL	Setting range [Default]	Description
3307	<b>Start pause time</b> [tSP]	2	1 to 99 s [7 s]	This is the delay time between the individual starting attempts.  This time is also used to protect the starter relay. The message "Start - Pause" is displayed.
3326	<b>Stop time of engine</b>  (Engine blocking)	2	0 to 99 s [10 s]	During this time a restart of the engine is blocked. This time should be configured so that the engine is total shutdown to protect the starting circuit.  Once speed from the engine is no longer detected the time configured in this parameter is initiated. The message "Stop engine" is displayed.  The LogicsManager command variable "Stop solenoid" (03.27) becomes TRUE as soon as the stop signal has been issued and remains true until this timer has expired.
3313	<b>Firing speed</b>	2	5 to 60 Hz [15 Hz]	After firing speed has been reached, the starter is disengaged.  The firing speed is to be configured low enough that it is always exceeded during regular generator operation.
				<b>Notes</b>  The time counter for the engine delayed monitoring is no longer activated directly by firing speed but by release engine monitoring 12999 ↗ p. 272.  Frequency measurement via the generator voltage input is possible beginning with 15 Hz or higher. If the MPU measurement is enabled, values down to 5 Hz can be measured.
3324	<b>LogicsManager for firing speed</b>	2	Yes  [No]	The engine firing speed is additionally monitored by the LogicsManager.  The firing speed is measured by the speed/frequency input (MPU), not via the LogicsManager.
				<b>Notes</b>  This LogicsManager can additionally use other sources to indicate the firing speed.
12500	<b>Firing speed</b>	2	Determined by LogicsManager [(0 & 1) & 1]	Once the conditions of the LogicsManager have been fulfilled the ignition speed will be recognized as above minimum limit (e.g. via an oil pressure switch).
				<b>Notes</b>  This screen is only visible if parameter 3324 ↗ p. 270 is configured to "Yes".  For information on the LogicsManager and its default settings see ↗ Chapter 9.4.1 "LogicsManager Overview" on page 689.  If the function "Start/Stop mode logic" (parameter 3321 ↗ p. 260) is configured to "Off" this LogicsManager must be used to active the engine delayed monitoring.
3315	<b>Engine monitoring delay time</b>  (Engine delayed monitoring [tED])	2	0 to 99 s [8 s]	Delay between reaching release engine monitoring and activation of the monitoring of engine speed delayed alarms (i.e. underspeed).  After reaching the firing speed, the engine delayed monitoring timer is started. Upon expiration of this timer all "engine delayed monitoring" configured alarms and discrete inputs will be enabled.  This timer should be configured in such a manner that it corresponds to the starting time of the engine plus any possible startup transients. A GCB closure may take place after the expiration of this timer.

ID	Parameter	CL	Setting range [Default]	Description
				<p><b>Notes</b></p> <p>The overall time engine monitoring is delayed from firing speed becoming TRUE (former version's setup), Delay On and Delay OFF of LM equation 11459 release engine monitoring must be added.</p> <p>The GCB closure can be initiated prior to engine delayed monitoring by configuring the LogicsManager "Undelay close GCB" (parameter 12210 ↗ p. 228).</p>
3316	Cool down time [tCD]	2	1 to 999 s [180 s]	<p><b>Regular stop</b></p> <p>If the engine performs a normal stop (start request is disabled or change into STOP operating mode) or a stop caused by an alarm of alarm class C/D, a cool down with an opened GCB is carried out. This time is programmable. The message "Cool down" is displayed and the LogicsManager command variable 04.10 becomes TRUE.</p> <p><b>Stop by a class 'C' or 'D' alarm</b></p> <p>If the engine is stopped by an alarm of this alarm class, a cool down is carried out with an opened GCB. This time is programmable.</p> <p><b>Stop by a class 'E' or 'F' alarm</b></p> <p>If the engine is stopped by an alarm of this alarm class, the engine is shut-down without a cool down immediately.</p>
				<p><b>Notes</b></p> <p>If a critical operation mode ( ↗ Chapter 4.5.10 "Emergency Run" on page 276) is initiated, the time configured in critical mode postrun (parameter 4109) will be used instead of the cool down time.</p>
3319	Cool down in STOP mode	2	[Yes]	A cool down will be performed if the genset is changed to STOP operation mode.
			No	No cool down will be performed if the genset is changed to STOP operation mode.
3322	Cool down without breaker	2		This parameter may be used to perform a cool down if the application mode (parameter 3401 ↗ p. 222) is configured to "None" or "GCB open".
			Yes	A cool down will be performed if a start signal is disabled or a stop signal is enabled.
			[No]	No cool down will be performed if a start signal is disabled or a stop signal is enabled.
				This parameter <b>only</b> applies to application mode <b>A01 A02</b> .
3300	Auxiliary services prerun [tPRE]  (Prerun auxiliary operation (start preparation))	2	0 to 999 s [0 s]	<p>Prior to a start sequence being initiated, the discrete output for the auxiliary services prerun (LogicsManager 03.30) remains enabled for the configured amount of time to permit engine related operations (i.e. open louvers) to be performed.</p> <p>While this discrete output is enabled the control screen will display the message "Aux.serv.prerun" for the configured time.</p> <p>The auxiliary services discrete output disables when the operation mode is changed from the MANUAL operation mode or, if engine speed is no longer detected, when the discrete output for the auxiliary services postrun (LogicsManager 03.31) is disabled.</p>
				<p><b>CAUTION</b></p> <p>During an emergency start this delay time "auxiliary prerun" is not initialized. The engine will be started immediately.</p>

ID	Parameter	CL	Setting range [Default]	Description
3301	<b>Auxiliary services postrun</b> [tPOST]  (Coasting auxiliary operation (post operation))	2	0 to 999 s  [0 s]	After each engine stop (the engine stop timer has expired), the discrete output for the auxiliary services postrun (LogicsManager 03.31) remains energized for an adjustable time (i.e. operate a cooling pump).  If the operating mode is changed from MANUAL to STOP or AUTOMATIC without a start command the relay remains energized for this period of time.  The message "Aux.serv.postrun" will be displayed on the control unit screen. In the "MANUAL" operating mode this relay output is not used.
12970	<b>MAN engine start</b>	2	Determined by LogicsManager  [[0 & 1) & 1]	With the rising edge of this LogicsManager equation an engine start command in operating mode MANUAL is initiated.
12971	<b>MAN engine stop</b>	2	Determined by LogicsManager  [[0 & 1) & 1]	With the rising edge of this LogicsManager equation an engine stop command in operating mode MANUAL is initiated. The state TRUE of this LM inhibits the start command in MANUAL.
12999	<b>Release eng.mon.</b>	2	Determined by LogicsManager  [[03.28 & 02.01) & 1]  t <sub>ON</sub> = 0.00; t <sub>OFF</sub> = 0.00]	Switch to activate the delayed engine monitoring e.g., oil pressure, under frequency, ...  <b>Notes</b> For more details see description below.

**Release Engine Monitoring**

This LogicsManager equation (ID = 12999 with logical command variable 11459) enables or blocks all monitoring functions, which are speed related by enabled setting: "Delayed by engine speed":

- Under/Over frequency
- Under speed
- Under voltage
- ...

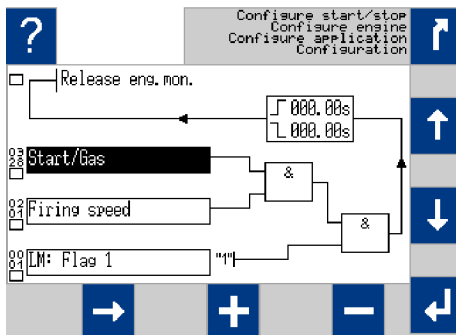

Fig. 96: Release Engine Monitoring screen

In the default setting of the easYgen the engine start/stop is executed by the easYgen directly. So the engine monitoring is released, if the control energizes the solenoid valve (03.28 ↪ p. 706) and the firing speed is reached. In the moment the easYgen removes the solenoid valve the monitoring is disabled. This avoids wrong alarms during the engine stopping procedure.

In cases the start/stop of the drive is executed from outside, the command variable 03.28 ↪ p. 706 is replaced by a command from outside i.e. any discrete input (09.XX). With starting the drive the operator gives the command for monitoring. With stopping the drive the command has to be removed to avoid wrong alarms during the engine stopping procedure.



The delayed engine monitoring can be seen with the upcoming "Eye" symbol in the single line diagram.



### 4.5.9.3 Magnetic Pickup Unit

To configure the MPU input, the number of teeth on the flywheel detected by the magnetic pick up (MPU) or the number of pickup pulses per revolution of the engine must be configured.

The table below shows the speed measuring range for various fly-wheel teeth numbers (parameter 1602 ↗ p. 274) and rated speeds (parameter 1601 ↗ p. 95) for a minimum signal voltage of  $2 V_{rms}$ .

Fly wheel teeth	Rated speed [rpm]	Speed measuring range [rpm]
10	1500	1200 to 4500
10	1800	1200 to 5400
10	3000	1200 to 9000
10	3600	1200 to 10800
25	750	480 to 2250
25	1500	480 to 4500
25	1800	480 to 5400
25	3000	480 to 9000
25	3600	480 to 10800
50	750	240 to 2250
50	1500	240 to 4500
50	1800	240 to 5400
50	3000	240 to 9000
50	3600	240 to 10800
100	750	120 to 2250
100	1500	120 to 4500
100	1800	120 to 5400
100	3000	120 to 6000
100	3600	120 to 6000
150	750	80 to 2250
150	1500	80 to 4000
150	1800	80 to 4000
150	3000	80 to 4000
150	3600	80 to 4000
200	750	60 to 2250
200	1500	60 to 3000
200	1800	60 to 3000
200	3000	60 to 3000
260	750	50 to 2250

Fly wheel teeth	Rated speed [rpm]	Speed measuring range [rpm]
260	1500	50 to 2300
260	1800	50 to 2300
280	750	45 to 2100
280	1500	45 to 2100
280	1800	45 to 2100
300	750	40 to 2000
300	1500	40 to 2000
300	1800	40 to 2000
400	750	30 to 1500
400	1500	30 to 1500
500	750	24 to 1200
600	750	20 to 1200
700	750	18 to 850
800	750	15 to 750

Table 50: MPU input - typical configurations

ID	Parameter	CL	Setting range [Default]	Description
1600	MPU input (Pickup)	2	[On]	Speed monitoring of the engine is carried out by the MPU.
			Off	Speed/frequency monitoring of the generator set (the engine) is performed by measuring the frequency of the generator. There is no MPU wired to this unit.
15155	Engine speed source	2	[Internal]	The internal MPU input is used as engine speed source.
			ECU/J1939	An external ECU/J1939 signal is used as speed source.
1602	Fly wheel teeth	2	2 to 800	Number of pulse per revolution/teeth on the flywheel.
			[118]	<p><b>Notes</b></p> <p>This parameter is only applicable if parameter 15155 ↗ p. 274 is set to "Internal".</p>

### 4.5.9.4 Idle Mode

#### General notes

When the engine is operated at idle speed, undervoltage, underfrequency, and underspeed monitoring as well as the monitoring of the flexible limits 33 through 40 are not performed.

This function allows for a controlled operation of an engine without alarm messages at a lower speed (below the configured underspeed monitoring values) for e.g. a warm-up operation with low emission.



The frequency controller output does not control the idle speed; it will remain in initial state position. The GCB cannot be closed in idle mode.



A message may be output to a relay here using the LogicsManager (Idle mode is active, command variable 04.15), e.g. as a signal for a speed controller. The display indicates "Idle run active" during idle mode.

 *The idle mode can be **only** used if the function is supported by the ECU or the frequency controller.*

 *The normal operation monitoring limits will be enabled again, if one of the following conditions is fulfilled:*

- *Idle mode has ended and generator frequency has reached rated frequency -1 Hz. (e.g. 49 Hz at 50 Hz rated)*
- *Idle mode has ended and engine delayed monitoring (parameter 3315  p. 270) has expired.*

 *The flexible limits 33 through 40 are disabled during idle mode operation (  Chapter 4.4.5 "Flexible Limits" on page 194).*

ID	Parameter	CL	Setting range [Default]	Description
12570	<b>Auto idle mode</b>	2	Determined by LogicsManager [[0 & 1] ≥ 0]	Once the conditions of the LogicsManager have been fulfilled the engine will be operated in idle mode automatically for the configured time during start-up. Monitoring is limited as described above.  This function may always be configured to "1" for example.
				<b>Notes</b>  For information on the LogicsManager and its default settings see  Chapter 9.4.1 "LogicsManager Overview" on page 689.
12550	<b>Constant idle run</b>  (Continuous idle mode)	2	Determined by LogicsManager [[0 & 1] & 0]	As long as the conditions of the LogicsManager have been fulfilled the engine will be continuously operated in idle mode. Monitoring is limited as described above. A key switch via a DI may be configured here for example.
				<b>Notes</b>  The idle mode is blocked if the GCB is already closed.  For information on the LogicsManager and its default settings see  Chapter 9.4.1 "LogicsManager Overview" on page 689.
3328	<b>Automatic idle time</b>  (Time for automatic idle mode)	2	1 to 9999 s [30 s]	The automatic idle mode is active for the time configured here. Monitoring is limited as described above during this time.

ID	Parameter	CL	Setting range [Default]	Description
3329	<b>During emergency / critical</b>  (Idle mode possible during emergency / critical operation)	2	Yes	If an emergency or critical operation is enabled, the engine will go to rated speed only after completing the configured idle mode.
			[No]	If an emergency or critical operation is enabled, no idle run will be performed. The engine will go directly to rated speed.

### 4.5.10 Emergency Run

#### General notes



*The emergency power operation is possible only in application mode **A04** (2 power circuit breakers).*

*If the LogicsManager outputs 'Stop request in AUTO' or 'Inhibit emergency run' are TRUE, an emergency power operation may be prevented or interrupted from an external source.*



**Prerequisites**

- *The emergency power function can only be activated for synchronous generators with parameter 2802 ↪ p. 277.*
- *Emergency power is carried out in operating mode AUTOMATIC regardless of the status of the LogicsManager output 'Start request in AUTO' (LogicsManager).*

The display indicates "Emergency run" during emergency power operation.

The following principles are observed in case of an emergency power operation:

- If an emergency power operation is initiated, the engine is started automatically, unless the start sequence is interrupted via an alarm or prevented via the LogicsManager or the operating mode is changed.
- The GCB can be closed regardless of the engine delay time if the generator frequency and voltage are within the configured operating limits ( ↪ Chapter 4.4.1.1 "Generator Operating Voltage / Frequency" on page 110) if the parameter "Undelay close GCB" (parameter 12210 ↪ p. 228) has been set accordingly (default setting).
- If the mains return during an emergency power operation (GCB is closed), the mains settling time (parameter 2801 ↪ p. 139) must expire before the load is transferred from the generator to mains operation.



**Activation of emergency power**

If the mains are not within the configured frequency and voltage operating limits ( ↩ Chapter 4.4.2.1 "Mains Operating Voltage / Frequency" on page 139) for at least the time configured in the parameter "Mains fail delay time" (parameter 2800 ↩ p. 277), an emergency power operation is activated.



**MCB malfunction**

An emergency power operation will be performed, if the control is not able to close or recluse the MCB and the alarm "Fail to close MCB" occurs.



**Mains rotation field alarm**

If the mains returns after a mains failure with a reversed rotation direction the generator remains in emergency power operation until the mains rotation matches the rotation of the generator set.

The generator will not start upon a mains rotation field alarm, but it will keep on running if it has already started.



The following parameters **only** apply to application mode **A04**.

ID	Parameter	CL	Setting range [Default]	Description
2802	On / Off (Monitoring)	2	[On]	If the unit is in the AUTOMATIC operating mode and a mains fault occurs according to the following parameters, the engine is started and an automatic emergency operation is carried out.
			Off	No emergency operation is carried out.
2800	Mains fail delay time (Mains failure start delay)	2	0.00 to 99.99 [3.00 s]	To start the engine and to carry out an emergency operation the monitored mains must be failed continuously for the minimum period of time set with this parameter.
				<b>Notes</b> This delay time starts only if the easYgen is in AUTOMATIC operating mode and emergency power is activated.
3408	Emerg. start with MCB failure	2	[Yes]/No	Emergency power operations may be configured with the failure of the MCB in addition to a loss of power on the mains supply.
				<b>Notes</b> An MCB breaker alarm is indicated if parameter "MCB monitoring" (parameter 2620 ↩ p. 191) is configured "On".
12200	Inhibit emergency power	2	Determined by LogicsManager [(0 & 1) & 1]	Once the conditions of the LogicsManager have been fulfilled the emergency power operation will be terminated or blocked.

ID	Parameter	CL	Setting range [Default]	Description
	(Inhibit emerg. run)			<p><b>Notes</b></p> <p>It is possible to interrupt an already activated emergency run.</p> <p>For information on the LogicsManager and its default settings see <a href="#">Chapter 9.4.1 "LogicsManager Overview" on page 689.</a></p>
4101	<b>Break emerg. in critical mode</b> (Override emergency operations in critical mode)	2	0 to 999 s [5 s]	The emergency power operations are overridden for the configured time when the critical mode starts in order to supply the complete generator power to the sprinkler pump.

## 4.5.11 Automatic Run

### General notes

The start of the engine can be performed via the following different logical conditions.

- A discrete input
- A temperature level
- An interface start condition
- A start request from the LDSS function
- A timer
- Any logical combination

If this logical output becomes TRUE in AUTOMATIC operating mode, the generator starts and the GCB will be closed. The simultaneous activation of other LogicsManager outputs (e.g. Stop req. in Auto) may affect this function.

The breaker handling depends on the configured application mode and breaker logic.



*Refer to Fig. 97 and [Chapter 9.4.3 "Logical Outputs" on page 693](#) for the priority of the logical outputs in case that more than one logical output is TRUE.*

Engine start conditions

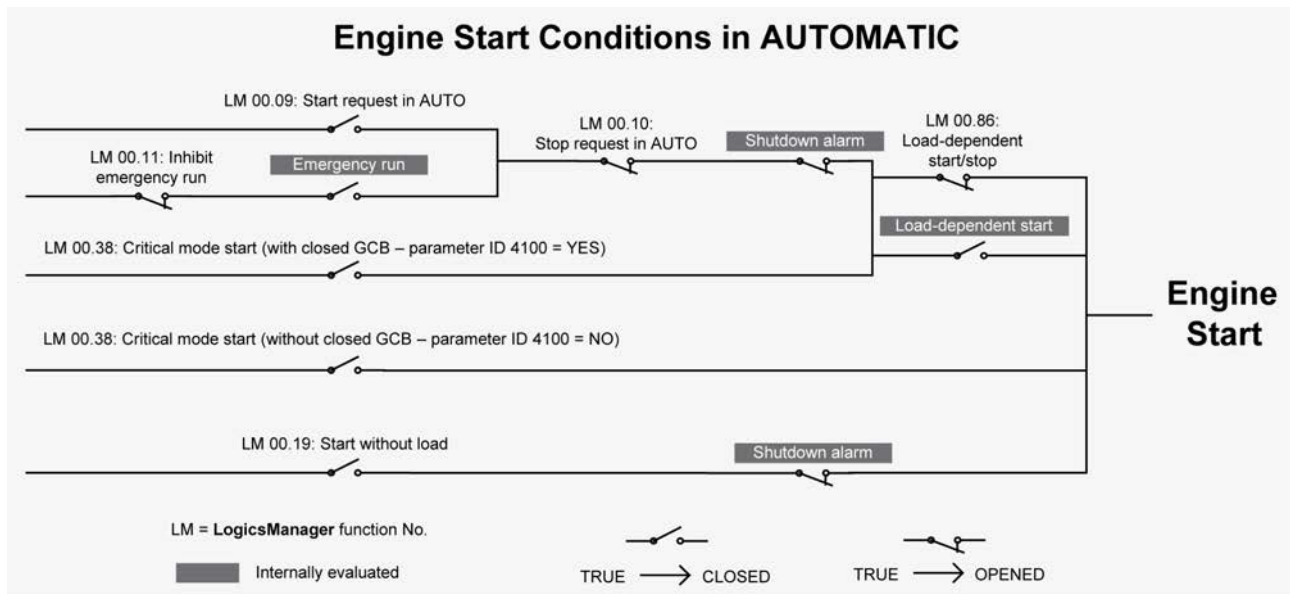

Fig. 97: Automatic run - engine start conditions

ID	Parameter	CL	Setting range [Default]	Description
12120	<b>Start req. in AUTO</b>  (Start request in operation mode AUTOMATIC)	2	Determined by LogicsManager  [[09.02 ≥ 0] ≥ 0]	Once the conditions of the LogicsManager have been fulfilled, the control issues a start request in AUTOMATIC mode.
				<b>Notes</b>  For information on the LogicsManager and its default settings see <a href="#">Chapter 9.4.1 "LogicsManager Overview" on page 689.</a>
12190	<b>Stop req. in AUTO</b>  (Stop request in operation mode AUTOMATIC)	2	Determined by LogicsManager  [[0 & 1] & 1]	If this logical output becomes TRUE, it inhibits all other start processes (e.g. Start req. in Auto, emergency power, etc.). Stopping of the engine can be initiated externally via a discrete input or any logical combination.  Once the conditions of the LogicsManager have been fulfilled, the control issues a stop request in AUTOMATIC mode.
				<b>Notes</b>  It is possible to interrupt an already activated emergency run.  For information on the LogicsManager and its default settings see <a href="#">Chapter 9.4.1 "LogicsManager Overview" on page 689.</a>
12540	<b>Start w/o load</b>  (Start without assuming load )	2	Determined by LogicsManager  [[0 & 1] & 1]	If this LogicsManager condition is TRUE switching from mains to generator supply following an engine start is prevented (the GCB close operation is blocked).  This function may be used to perform a test operation. If an emergency power case occurs meanwhile, it is still possible to change to generator operation.  If this condition becomes TRUE in isolated operation, the GCB cannot be opened before the MCB has been closed.
				<b>Notes</b>  For information on the LogicsManager and its default settings see <a href="#">Chapter 9.4.1 "LogicsManager Overview" on page 689.</a>

ID	Parameter	CL	Setting range [Default]	Description	
1795	<b>Startup in mode</b>  (Operating mode after applying the power supply )	2	[Default]	If the controller is powered down, the unit will start in the following configured mode when it is powered up again.	
			[STOP]	The unit starts in the STOP operating mode.	
			AUTO	The unit starts in the AUTOMATIC operating mode.	
			MAN	The unit starts in the MANUAL operating mode.	
			Last	The unit starts in the last operating mode the control was in prior to being de-energized.	
				<p><b>Notes</b></p> <p>For the selection of the operating mode via the LogicsManager (if two different operating modes have been selected simultaneously) the control unit will prioritize the modes as follows:</p> <ul style="list-style-type: none"> <li>■ 1. STOP</li> <li>■ 2. MANUAL</li> <li>■ 3. AUTOMATIC</li> </ul>	
12510	<b>Operat. mode AUTO</b>  (Activate operating mode AUTOMATIC )	2	<b>WARNING!</b>	In Operation mode AUTO (intentionally): <ul style="list-style-type: none"> <li>■ the STOP button on front panel is without function and</li> <li>■ the soft buttons for operation mode selection are not displayed.</li> </ul>	
				<p><b>Notes</b></p> <p>If both Operation mode AUTO and 12120 ↗ p. 279 Start req in AUTO are active the generator will start automatically with acknowledgement of the latest failure.</p>	
			Determined by LogicsManager	Once the conditions of the LogicsManager have been fulfilled the unit will change into operating mode AUTOMATIC.	
			[[0 & 1] & 1]	<p><b>Notes</b></p> <p>For information on the LogicsManager and its default settings see ↗ Chapter 9.4.1 "LogicsManager Overview" on page 689.</p>	
12520	<b>Operat. mode MAN</b>  (Activate operating mode MANUAL)	2	Determined by LogicsManager	Once the conditions of the LogicsManager have been fulfilled the unit will change into operating mode MANUAL.	
				[[0 & 1] & 1]	If MANUAL mode is selected via the LogicsManager it is not possible to change operating modes via the front panel.
					<p><b>Notes</b></p> <p>For information on the LogicsManager and its default settings see ↗ Chapter 9.4.1 "LogicsManager Overview" on page 689.</p>
12530	<b>Operat. mode STOP</b>  (Activate operating mode STOP)	2	Determined by LogicsManager	Once the conditions of the LogicsManager have been fulfilled the unit will change into operating mode STOP.	
				[[0 & 1] & 1]	If STOP mode is selected via the LogicsManager it is not possible to change operating modes via the front panel.
					<p><b>Notes</b></p> <p>For information on the LogicsManager and its default settings see ↗ Chapter 9.4.1 "LogicsManager Overview" on page 689.</p>



ID	Parameter	CL	Setting range [Default]	Description
5775	IOP Delayed unload. Alarm C,E	2	0 to 9999 s [0 s]	<p>This parameter gives a load sharing participant the opportunity to delay the unload if an shutdown alarm of alarm class C or E occurs. The time gained gives another generator the chance to participate in the load sharing network.</p> <p>The time configured here delays the triggering of alarm class C and E. A setting of 0 s deactivates this function.</p>
				<p><b>Notes</b></p> <p>For additional information refer to <a href="#">Chapter 9.5.1 "Alarm Classes"</a> on page 733</p>

#### 4.5.11.1 Load Dependent Start Stop (LDSS)

##### General notes

Load-dependent start/stop may either be performed according to a system reserve power or the generator load depending on the configuration of the "Start stop mode" (parameter 5752 [p. 285](#)).



Refer to [Chapter 9.6.1 "Load Dependent Start Stop \(LDSS\) Formulas"](#) on page 747 for all formulas related to the LDSS function.

##### 4.5.11.1.1 Generator Capacity Utilization

If the "Start stop mode" (parameter 5752 [p. 285](#)) is configured to "Generator load", load-dependent start stop is performed in a way that the next genset will be started if all gensets in operation reach the maximum generator load (parameter 5762 [p. 288](#) or 5770 [p. 292](#) "IOP/MOP Max. generator load"), a configured percentage (e.g. 80 %) of the rated power. In order to stop one generator, the load of all gensets in operation must fall below the minimum generator load (parameter 5763 [p. 288](#) or 5771 [p. 292](#) "IOP/MOP Min. generator load"), a configured percentage (e.g. 30 %) of the rated power. There are different setpoints for isolated and mains parallel operation.

An additional dynamic parameter (parameter 5757 [p. 289](#) or 5758 [p. 293](#) "IOP/MOP Dynamic") prevents the gensets from being started and stopped continuously if only a few gensets are in operation.

This function provides an easy calculation for the start of the next genset.



– Refer to the description of the dynamic parameters for detailed information.

The following parameters need to be configured for this operation:

Parameter ID	Parameter text	Note
5757	IOP Dynamic	only for isolated operation
5758	MOP Dynamic	only for mains parallel operation
5767	MOP Minimum load	only for mains parallel operation
5769	MOP Hysteresis	only for mains parallel operation
5770	MOP Max. generator load	only for mains parallel operation

*Table 51: Load-dependent start/stop - parameters for generator load operation*

### Isolated operation (IOP)

If the configured maximum generator capacity utilization is exceeded, another genset will be added.

- $PGN_{\text{real active}} > P_{\text{max. load isolated}}$

If the configured minimum generator capacity utilization has been fallen below, a genset will be stopped depending on the dynamic setting (parameter 5757 ↪ p. 289).

- $PGN_{\text{real active}} < P_{\text{min. load isolated}}$

### Mains parallel operation (MOP)

If the required generator load setpoint for the control at the mains interchange point exceeds the MOP minimum load threshold (parameter 5767 ↪ p. 291), the first genset will be added.

- $PMN_{\text{setpoint}} - PMN_{\text{real}} > PMOP_{\text{minimum}}$

If at least one genset is supplying the load in parallel with the mains and the total generator load exceeds the MOP maximum generator load threshold (parameter 5770 ↪ p. 292), another genset will be added.

- $PGN_{\text{real active}} > P_{\text{max. load parallel}}$

If at least two gensets are supplying the load in parallel with the mains and the configured minimum generator capacity utilization has been fallen below, a genset will be stopped depending on the dynamic setting (parameter 5758 ↪ p. 293)

- $PGN_{\text{real active}} < P_{\text{min. load parallel}}$

If one genset is supplying the load in parallel with the mains and the generator load exceeds the MOP minimum load threshold (parameter 5767 ↪ p. 291) minus the hysteresis (parameter 5769 ↪ p. 292), the genset will be stopped.

The hysteresis is intended to prevent frequent starting and stopping of gensets in case of small load variations.

- $PMN_{\text{setpoint}} - PMN_{\text{real}} + PGN_{\text{real active}} < PMOP_{\text{minimum}} - P_{\text{hysteresis MOP}}$

### 4.5.11.1.2 System Reserve Power

If the "Start stop mode" (parameter 5752 ↗ p. 285) is configured to "Reserve power", load-dependent start stop is performed in a way that a configured minimum reserve power is maintained in the system. This means that there is always enough reserve power for load swings on the busbar regardless of the generator load. The actual reserve power in the system is the total rated power of all gensets on the busbar minus the actual total generator real power.

This functionality provides high system reliability and is intended for applications that require a dedicated reserve power on the busbar, independent of the number of gensets on the busbar.

The following parameters need to be configured for this operation:

Parameter ID	Parameter text	Note
5760	IOP Reserve power	only for isolated operation
5761	IOP Hysteresis	only for isolated operation
5767	MOP Minimum load	only for mains parallel operation
5768	MOP Reserve power	only for mains parallel operation
5769	MOP Hysteresis	only for mains parallel operation

Table 52: Load-dependent start/stop - parameters for reserve power operation

#### Isolated operation (IOP)

- $P_{Reserve} = P_{rated\ active} - P_{GN\ real\ active}$
- $P_{rated\ active} = P_{RatedGen[1]} + P_{RatedGen[2]} + \dots + P_{RatedGen[n]}$   
(total rated power of all gensets on the busbar in the system)
- $P_{GN\ real\ active} = P_{ActualGen[1]} + P_{ActualGen[2]} + \dots + P_{ActualGen[n]}$   
(total actual load of all gensets on the busbar in the system)

If the reserve power falls below the IOP reserve power threshold (parameter 5760 ↗ p. 288), another genset will be added.

- $P_{Reserve} < P_{Reserve\ IOP}$

If the reserve power exceeds the IOP reserve power threshold (parameter 5760 ↗ p. 288) plus the hysteresis (parameter 5761 ↗ p. 288) plus the rated load of the genset, the genset will be stopped.

The hysteresis is intended to prevent frequent starting and stopping of gensets in case of small load variations.

- $P_{reserve} > P_{reserve\ isolated\ IOP} + P_{hysteresis\ IOP} + P_{RatedGen}$

#### Mains parallel operation (MOP)

- $P_{reserve} = P_{rated\ active} - P_{GN\ real\ active}$
- $P_{rated\ active} = P_{RatedGen[1]} + P_{RatedGen[2]} + \dots + P_{RatedGen[n]}$   
(total rated power of all gensets on the busbar in the system)
- $P_{GN\ real\ active} = P_{ActualGen[1]} + P_{ActualGen[2]} + \dots + P_{ActualGen[n]}$   
(total actual load of all gensets on the busbar in the system)

If the required generator load setpoint for the control at the mains interchange point exceeds the MOP minimum load threshold (parameter 5767 ↗ p. 291), the first genset will be added.

$$\blacksquare P_{MN \text{ setpoint}} - P_{MN \text{ real}} > P_{MOP \text{ minimum}}$$

If at least one genset is supplying the load in parallel with the mains and the reserve power falls below the reserve power threshold (parameter 5768 ↗ p. 292), another genset will be added.

$$\blacksquare P_{\text{reserve}} < P_{\text{reserve parallel}}$$

If at least two gensets are supplying the load in parallel with the mains and the reserve power exceeds the MOP reserve power threshold (parameter 5768 ↗ p. 292) plus the hysteresis (parameter 5769 ↗ p. 292) plus the rated load of the genset, the genset will be stopped.

The hysteresis is intended to prevent frequent starting and stopping of gensets in case of small load variations.

$$\blacksquare P_{\text{reserve}} > P_{\text{reserve parallel}} + P_{\text{hysteresis MOP}} + P_{\text{RatedGen}}$$

If one genset is supplying the load in parallel with the mains and the generator load exceeds the MOP minimum load threshold (parameter 5767 ↗ p. 291) minus the hysteresis (parameter 5769 ↗ p. 292), the genset will be stopped.

The hysteresis is intended to prevent frequent starting and stopping of gensets in case of small load variations.

$$\blacksquare P_{MN \text{ setpoint}} - P_{MN \text{ real}} + P_{GN \text{ real active}} < P_{MOP \text{ minimum}} - P_{\text{hysteresis MOP}}$$

### 4.5.11.1.3 Generator Selection

#### General notes

If a genset is to be started, the genset with the highest priority configured will be started. If a genset is to be stopped, the genset with the lowest priority configured will be stopped.

If all gensets have the same priority, the next genset is selected according to the size of engine, i.e. the genset combination, which allows an optimum efficiency will be used.

If all gensets have the same rated load or this parameter is disabled, the remaining hours until the next maintenance are considered. If these are also the same, the genset with the lowest generator number will be started first or stopped last.

Priority order:

- 1. Priority (parameter 5751 ↗ p. 285)
- 2. Efficiency (size of engines) (parameter 5754 ↗ p. 286)
- 3. Service hours (parameter 5755 ↗ p. 286)
- 4. Generator (device) number (parameter 1702 ↗ p. 92)

The load-dependent start/stop function requires the following conditions have been met:

- The control has been placed in AUTOMATIC operating mode
- A start request (Start req. in AUTO, Emergency run) is active
- All load sharing parameters are configured identically for all generators participating in load sharing ( ↗ Chapter 4.4.6.11 "Multi-Unit Parameter Alignment" on page 209)

- The mains interchange load control (import/export power) has been enabled or the gensets are in isolated operation
- The conditions of the LogicsManager function "Load-dependent start/stop" have been fulfilled

ID	Parameter	CL	Setting range [Default]	Description
12930	<b>LD start stop</b> (Load-dependent start stop)	2	Determined by LogicsManager  [[0 & !04.27] & !00.19]	Once the conditions of the LogicsManager have been fulfilled, the load-dependent start/stop function is enabled.
				<b>Notes</b> For information on the LogicsManager and its default settings see <a href="#">Chapter 9.4.1 "LogicsManager Overview" on page 689</a> .
5752	<b>Start stop mode</b>	2	<b>[Reserve power]</b>	Load-dependent start stop is performed in a way that a configured minimum reserve power is maintained in the system. The reserve power is the total generator rated power minus the total actual generator power.  If the reserve power falls below the threshold, another genset will be started. If the reserve power is sufficient to stop one genset without falling below the threshold, a genset will be stopped.
			Generator load	Load-dependent start stop is performed in a way that a configured maximum generator capacity utilization is not exceeded.  If the generator capacity utilization exceeds this threshold, another genset will be started. If the generator capacity utilization is low enough to stop one genset without exceeding the threshold again, a genset will be stopped.
5753	<b>Dead busbar start mode</b>	2	<b>[All]</b>	All available gensets will be started in case of a dead busbar and remain connected to the busbar for the minimum running time (parameter 5759 <a href="#">p. 287</a> ). Then the gensets will be stopped according to the configured LDSS procedure. The start delay is configured in parameter 2800 <a href="#">p. 277</a> (Mains fail delay time).
			LDSS	The start of the gensets will be performed according to the configured LDSS priority in case of a dead busbar.
				<b>Notes</b> This function cannot be used as an emergency power function in mains parallel operations because it cannot control the MCB operation.  If the MCB should be operated, the emergency run function (parameter 2802 <a href="#">p. 277</a> ) must be enabled.
5751	<b>Base priority</b>	2	1 to 32  <b>[5]</b>	The priority of the genset in the load-dependent start/stop network is configured with this parameter ( <a href="#">Chapter 4.5.11.1.3 "Generator Selection" on page 284</a> ). The lower the number configured here, the higher the priority.  This priority may be overridden by the LDSS Priority parameters (parameters 12924 <a href="#">p. 286</a> , 12925 <a href="#">p. 286</a> , and 12926 <a href="#">p. 285</a> ).
12926	<b>LDSS Priority 2</b>	2	Determined by LogicsManager  [[0 & 1] & 1]	Once the conditions of the LogicsManager have been fulfilled, the load-dependent start/stop priority will be set to 2 (the highest priority is valid).
				<b>Notes</b> For information on the LogicsManager and its default settings see <a href="#">Chapter 9.4.1 "LogicsManager Overview" on page 689</a> .

## Configuration

Configure Application > Automatic Run > Load Dependent Start Stop ...

ID	Parameter	CL	Setting range [Default]	Description
12925	LDSS Priority 3	2	Determined by LogicsManager [[0 & 1] & 1]	Once the conditions of the LogicsManager have been fulfilled, the load-dependent start/stop priority will be set to 3 (the highest priority is valid).
			<b>Notes</b> For information on the LogicsManager and its default settings see <a href="#">Chapter 9.4.1 "LogicsManager Overview" on page 689.</a>	
12924	LDSS Priority 4	2	Determined by LogicsManager [[0 & 1] & 1]	Once the conditions of the LogicsManager have been fulfilled, the load-dependent start/stop priority will be set to 4 (the highest priority is valid).
			<b>Notes</b> For information on the LogicsManager and its default settings see <a href="#">Chapter 9.4.1 "LogicsManager Overview" on page 689.</a>	
5754	Fit size of engine	2		This parameter defines whether the start/stop priority order ( <a href="#">Chapter 4.5.11.1.3 "Generator Selection" on page 284</a> ) considers the size of the engine (generator rated power) or not. In case of different sized gensets, the control can start a genset combination which results in optimum efficiency.  The fuel efficiency may be optimized when this parameter is enabled. This parameter may be disabled if all generators have the same size.
			Yes	The priority order considers the engine size for the start of the next engine for gensets with the same priority.
			[No]	The priority order does not consider the rated power of the engines to fit the best size of engines.
5755	Fit service hours	2	[Off]	The remaining hours until the next service is required are not considered when evaluating the engines to be started.
			Staggered	The remaining hours until the next service is required are considered when evaluating the engines to be started for gensets with same priority. The gensets are utilized in a way that the maintenance may be performed at different times to ensure that not all gensets have a downtime due to a maintenance at the same time. The genset with the lowest hours until the next service will be started first.
			Equal	The remaining hours until the next service is required are considered when evaluating the engines to be started for gensets with same priority. The gensets are utilized in a way that the maintenance may be performed at the same time for all gensets. The genset with the highest hours until the next service will be started first.
5756	Changes of engines	2		<p>Engine sequencing may be configured to start and stop engines according to the time remaining until the maintenance hours counter (parameter 2550 <a href="#">p. 379</a>) expires (counter reaches 0 hrs).</p> <p>The easYgen takes the time remaining on the maintenance hours counter and divides it by the service hours group (32/64/128 h) configured in this parameter to determine the individual unit's time group.</p> <p>A generator with a larger time group number has more time remaining before the maintenance hours timer expires and is considered to be the higher priority generator.</p> <p>If two generators are in the same time group, the configured generator number determines which generator is the higher priority and will be started first.</p> <p>This functionality enables the end user to have multiple generators due for service at approximately the same time.</p>

ID	Parameter	CL	Setting range [Default]	Description
			[Off]	No engine change will be performed. The engines are selected according to the setting of parameter 5755 ↗ p. 286 (Fit service hours) with 1 hour spacing in case of load changes.
			All 32/64/128 h	If parameter 5754 ↗ p. 286 (Fit size of engine) is configured to "Yes", only engines with the same rated power and priority are changed, if it is configured to "No", engines with the same priority are changed depending on the service hours and generator number. All engines are divided into 32/64/128 service hour groups. An engine change is performed if one engine changes to another group in 32/64/128 hour spacing.
				<p><b>Example 1</b></p> <ul style="list-style-type: none"> <li>■ "Changes of engines" is configured to "All 64h"</li> <li>■ Generator 1 has 262 maintenance hours remaining</li> <li>■ Generator 2 has 298 maintenance hours remaining</li> <li>■ The time group for generator 1 is calculated as: <math>262h/64h = 4.09 =</math> Time group 4</li> <li>■ The time group for generator 2 is calculated as: <math>298h/64h = 4.66 =</math> Time group 4</li> <li>■ Both generators are in time group 4.</li> </ul> <p>Time group 4 consists of any generator that the time group calculation total ranges from 4.00 through 4.99.</p> <p>In this instance the assigned generator number is used to determine which generator is brought online. Generator 1 will be started.</p> <p><b>Example 2</b></p> <ul style="list-style-type: none"> <li>■ "Changes of engines" is configured to "All 64h"</li> <li>■ Generator 1 has 262 maintenance hours remaining</li> <li>■ Generator 2 has 345 maintenance hours remaining</li> <li>■ Generator 3 has 298 maintenance hours remaining</li> <li>■ The time group for generator 1 is calculated as: <math>262h/64h = 4.09 =</math> Time group 4</li> <li>■ The time group for generator 2 is calculated as: <math>345h/64h = 5.39 =</math> Time group 5</li> <li>■ The time group for generator 3 is calculated as: <math>298h/64h = 4.66 =</math> Time group 4</li> <li>■ Generators 1 and 3 are in time group 4.</li> <li>■ Time group 4 consists of any generator that the time group calculation total ranges from 4.00 through 4.99.</li> <li>■ Generator 2 is in time group 5.</li> <li>■ Time group 5 consists of any generator that the time group calculation total ranges from 5.00 through 5.99.</li> </ul> <p>In this instance the largest time group will determine which generator is brought online. Generator 2 will be started because it is in time group 5.</p>
				<p><b>Notes</b></p> <p>This parameter is only effective if fit service hours (parameter 5755 ↗ p. 286) is configured to "Equal".</p>
5759	Minimum running time	2	0 to 32000 s [180 s]	<p>If a genset has been started by the LDSS function, it continues to operate at least for this time even if it would have been stopped before.</p> <p>This timer is started with the closure of the GCB. If an emergency run is active ( ↗ Chapter 4.5.10 "Emergency Run" on page 276) and the mains return, this timer will be overridden and the load is transferred back to the mains after the mains settling time (parameter 2801 ↗ p. 139) has expired.</p>

4.5.11.1.4 Isolated Parallel Operation (IOP)

General notes

In case of an isolated parallel operation (MCB open), the first genset will be connected to the de-energized busbar.



*At least one genset must be in operation in isolated operation.*

There are dedicated LDSS parameters for isolated parallel operation because the supply of the load is important here.

ID	Parameter	CL	Setting range [Default]	Description
5760	<b>IOP Reserve power</b>	2	1 to 999999 kW [100 kW]	The value configured for the reserve power determines when an additional generator will be started. The reserve power is the desired spinning reserve of a generator or generators. The reserve power is usually estimated as the largest load swing that a power plant may encounter during the time it takes to bring an additional generator online.  The available generator power is calculated by adding up the generator real power ratings of all generators with closed GCBs. The reserve generator power is calculated by subtracting the power currently being produced by all generators with closed GCBs from the total available generator power.  If the actual reserve power of the generators is less than the value configured in this parameter, the next generator will be started.
				Currently available total generator rated real power
			–	Currently available total generator actual real power
			=	Reserve power
				<b>Notes</b> This parameter is only effective if start stop mode (parameter 5752 ↗ p. 285) is configured to "Reserve power".
5761	<b>IOP Hysteresis</b>	2	1 to 65000 kW [20 kW]	If the reserve power is sufficient to stop one genset without falling below the threshold and the hysteresis configured here, a genset will be stopped.  <b>Notes</b> This parameter is only effective if start stop mode (parameter 5752 ↗ p. 285) is configured to "Reserve power".
5762	<b>IOP Max. generator load</b>	2	0 to 100 % [70 %]	If the generator load exceeds the threshold configured here, the load-dependent start/stop function will start another genset.  <b>Notes</b> This parameter is only effective if start stop mode (parameter 5752 ↗ p. 285) is configured to "Generator load".  The maximum generator load must be configured higher than the minimum generator load for proper operation.
5763	<b>IOP Min. generator load</b>	2	0 to 100 % [30 %]	If the generator load falls below the threshold configured here, the load-dependent start/stop function will stop a genset. If only a few gensets are operating in a multi-genset application, the IOP Dynamic (parameter 5757 ↗ p. 289) will also be considered when stopping a genset.



ID	Parameter	CL	Setting range [Default]	Description
				<p><b>Notes</b></p> <p>This parameter is only effective if start stop mode (parameter 5752 ↗ p. 285) is configured to "Generator load".</p> <p>The maximum generator load must be configured higher then the minimum generator load for proper operation.</p>
5757	IOP Dynamic	2		<p>The dynamic determines when to start or stop the next genset and shows the following behavior:</p> <p><b>Starting genset</b></p> <p>The control requests a certain amount of additional load depending on the dynamic. It may start two or more gensets to supply the required load. Also refer to the following example.</p> <p><b>Stopping genset</b></p> <p>The dynamic determines how soon a genset will be stopped. It prevents continuous start and stop if only a few gensets are in operation. In this case, the remaining gensets would not reach the maximum limit if one genset stops (if, for example, two gensets with 100 kW rated load, a minimum load of 40 % and a maximum load of 70 % are operated, the second genset will be shut down if both reach 40 kW and the remaining engine would operate with 80 kW and request the next engine and so on). The more gensets are running, the less the influence of this parameter. Also refer to the following example.</p>
			[Low]	<p><b>Starting genset</b></p> <p>A larger genset is requested and it will take longer until the next change is required. The engines are operated with more reserve power. The requested load is calculated so that the gensets will be loaded with 25 % of the range between minimum and maximum generator load (parameters 5762 ↗ p. 288 &amp; 5763 ↗ p. 288) after the new genset has been started.</p> <p><b>Stopping genset</b></p> <p>The genset will shut down at a lower limit and be operated longer. The number of gensets in operation will remain constant for a wider range of load. The load on the remaining gensets must not exceed 25 % of the range between minimum and maximum generator load (parameters 5762 ↗ p. 288 &amp; 5763 ↗ p. 288).</p>
			Moderate	<p><b>Starting genset</b></p> <p>A medium genset is requested. The requested load is calculated so that the gensets will be loaded with 50 % of the range between minimum and maximum generator load (parameters 5762 ↗ p. 288 &amp; 5763 ↗ p. 288) after the new genset has been started.</p> <p><b>Stopping genset</b></p> <p>The load on the remaining gensets must not exceed 50 % of the range between minimum and maximum generator load (parameters 5762 ↗ p. 288 &amp; 5763 ↗ p. 288).</p>

ID	Parameter	CL	Setting range [Default]	Description
			High	<p><b>Starting genset</b></p> <p>A smaller genset is requested to operate the engines with higher efficiency. This may lead to more frequent starts and stops. The requested load is calculated so that the gensets will be loaded with 75 % of the range between minimum and maximum generator load (parameters 5762 ↗ p. 288 &amp; 5763 ↗ p. 288) after the new genset has been started.</p> <p><b>Stopping genset</b></p> <p>The genset will be shut down earlier. This may lead to more frequent starts and stops. The load on the remaining gensets must not exceed 75 % of the range between minimum and maximum generator load (parameters 5762 ↗ p. 288 &amp; 5763 ↗ p. 288).</p>
				<p><b>Notes</b></p> <p>This parameter is only effective if start stop mode (parameter 5752 ↗ p. 285) is configured to "Generator load".</p>
				<p><b>Example (Starting genset)</b></p> <p>A plant made up of several gensets with a rated power of 50, 100, and 200 kW is configured to a maximum generator load of 70 % and a minimum generator load of 40 %. One genset with 200 kW is running and the actual load reaches 140 kW. This is the 70 % maximum load limit of the running genset and requires the start of the next genset.</p> <ul style="list-style-type: none"> <li>■ Low: a total generator rated power of 294.7 kW is requested and a 100 kW genset will be started.</li> <li>■ Moderate: a total generator rated power of 254.5 kW is requested and a 100 kW genset will be started.</li> <li>■ High: a total generator rated power of 224.0 kW is requested and a 50 kW genset will be started.</li> </ul> <p>Refer to ↗ <i>Chapter 9.6.1 "Load Dependent Start Stop (LDSS) Formulas"</i> on page 747 for details about the formulas used for calculation.</p>
				<p><b>Example (Stopping genset)</b></p> <p>Two gensets with the same rated power are configured to a maximum generator load of 70 % and a minimum generator load of 40 %.</p> <p>The following example shows the load level before stopping the second genset and the resulting load level for the first genset depending on the dynamic setting.</p> <ul style="list-style-type: none"> <li>■ Low: <ul style="list-style-type: none"> <li>Load level before stopping: 23.75 %</li> <li>Resulting load level for remaining engine: 47.5 % (25 % of the difference between 70 and 40 %)</li> </ul> </li> <li>■ Moderate: <ul style="list-style-type: none"> <li>Load level before stopping: 27.5 %</li> <li>Resulting load level for remaining engine: 55 % (50 % of the difference between 70 and 40 %)</li> </ul> </li> <li>■ High: <ul style="list-style-type: none"> <li>Load level before stopping: 31.25 %</li> <li>Resulting load level for remaining engine: 62.5 % (75 % of the difference between 70 and 40 %)</li> </ul> </li> </ul>

ID	Parameter	CL	Setting range [Default]	Description
5764	IOP Add on delay	2	0 to 32000 s [10 s]	<p>Load swings may exceed the threshold momentarily. In order to prevent the engine from starting due to short-term load swings, a delay time may be configured.</p> <p>The LDSS criterion for adding load must be exceeded without interruption for this delay time, configured in seconds, prior to a start command being issued.</p> <p>If the LDSS criterion for adding load is fallen below before the delay time expires, the delay time is reset and a start command is not issued.</p>
5765	IOP Add on delay at rated load	2	0 to 32000 s [3 s]	<p>The command to start the next genset in case a genset exceeds rated load will be issued after the delay configured here has expired.</p> <p><b>Notes</b></p> <p>This parameter becomes only effective in case a genset exceeds rated load to achieve a faster start and overrides parameter 5764 ↗ p. 291.</p>
5766	IOP Add off delay	2	0 to 32000 s [60 s]	<p>Load swings may fall below the threshold momentarily. In order to prevent the engine from stopping due to short-term load swings, a delay time may be configured.</p> <p>The load must remain below the hysteresis setpoint without interruption for the delay time, configured in seconds, prior to a stop command being issued.</p> <p>If the load exceeds the hysteresis setpoint before the delay time expires, the delay time is reset and a stop command is not issued.</p>

#### 4.5.11.1.5 Mains Parallel Operation

##### General notes

In case of a mains parallel operation (MCB closed), load-dependent start stop is only enabled, if the gensets participates in load sharing at the interchange point (all participating gensets must be configured to the same setpoint).



*A minimum load threshold must be exceeded to start the first genset, i.e. a genset will only be started if a minimum load would be demanded from the generator.*

*There are dedicated LDSS parameters for mains parallel operation.*

ID	Parameter	CL	Setting range [Default]	Description
5767	MOP Minimum load	2	0 to 65000 kW [10 kW]	<p>For the mains interchange (import/export) real power control to function, a minimum generator power setpoint value is required to start the first genset.</p> <p>In many cases, it is desirable that the engine is prevented from starting unless the generator will operate at a specific kW level or higher to ensure a reasonable degree of efficiency.</p> <p><b>Example</b></p> <p>The mains interchange must reach a level that will permit an 80 kW generator to operate at a minimum load of 40 kW prior to the engine starting.</p>

## Configuration

Configure Application > Automatic Run > Load Dependent Start Stop ...

ID	Parameter	CL	Setting range [Default]	Description
5769	<b>MOP Hysteresis</b>	2	0 to 65000 kW [20 kW]	Start stop mode configured to "Reserve power":  If the reserve power is sufficient to stop one genset without falling below the reserve power threshold and the hysteresis configured here, a genset will be stopped.  If the generator load falls below the minimum load threshold minus the hysteresis configured here, the last genset will be stopped.
				<b>Notes</b> The importance of this parameter depends on the setting of the start stop mode (parameter 5752 ↪ p. 285).
5768	<b>MOP Reserve power</b>	2	0 to 999999 kW [50 kW]	The minimum reserve power in mains parallel operation is configured here. This is the maximum expected load swing on the busbar, which shall be supported by the gensets.  If the reserve power falls below this value, the load-dependent start/stop function will start another genset.
				<b>Notes</b> This parameter is only effective if start stop mode (parameter 5752 ↪ p. 285) is configured to "Reserve power".
5770	<b>MOP Max. generator load</b>	2	0 to 100 % [70 %]	If the generator load exceeds the threshold configured here, the load-dependent start/stop function will start another genset.
				<b>Notes</b> This parameter is only effective if start stop mode (parameter 5752 ↪ p. 285) is configured to "Generator load".  The maximum generator load must be configured higher than the minimum generator load for proper operation.
5771	<b>MOP Min. generator load</b>	2	0 to 100 % [30 %]	If the generator load falls below the threshold configured here, the load-dependent start/stop function will stop a genset.  If only a few gensets are operating in a multi-genset application, the MOP Dynamic (parameter 5758 ↪ p. 293) will also be considered when stopping a genset.
				<b>Notes</b> This parameter is only effective if start stop mode (parameter 5752 ↪ p. 285) is configured to "Generator load".  The maximum generator load must be configured higher than the minimum generator load for proper operation.

ID	Parameter	CL	Setting range [Default]	Description
5758	MOP Dynamic	2		<p>The dynamic determines when to start or stop the next genset and shows the following behavior:</p> <p><b>Starting genset</b></p> <p>The Dynamic is only considered for the start sequence if "Fit size of engines" is enabled (refer to parameter 5754 ↗ p. 286).</p> <p>The control requests a certain amount of additional load depending on the dynamic. It may start two or more gensets to supply the required load.</p> <p><b>Stopping genset</b></p> <p>The dynamic determines how soon a genset will be stopped. It prevents continuous start and stop if only a few gensets are in operation.</p> <p>In this case, the remaining gensets would not reach the maximum limit if one genset stops (if, for example, two gensets with 100 kW rated load, a minimum load of 40 % and a maximum load of 70 % are operated, the second genset will be shut down if both reach 40 kW and the remaining engine would operate with 80 kW and request the next engine and so on).</p> <p>The more gensets are running, the less the influence of this parameter. Also refer to the following example.</p>
			[Low]	<p><b>Starting genset</b></p> <p>A larger genset is requested and it will take longer until the next change is required. The engines are operated with more reserve power. The requested load is calculated so that the gensets will be loaded with 25 % of the range between minimum and maximum generator load (parameters 5762 ↗ p. 288 &amp; 5763 ↗ p. 288) after the new genset has been started.</p> <p><b>Stopping genset</b></p> <p>The genset will shut down at a lower limit and be operated longer. The number of gensets in operation will remain constant for a wider range of load. The load on the remaining gensets must not exceed 25 % of the range between minimum and maximum generator load (parameters 5762 ↗ p. 288 &amp; 5763 ↗ p. 288).</p>
			Moderate	<p><b>Starting genset</b></p> <p>A medium genset is requested. The requested load is calculated so that the gensets will be loaded with 50 % of the range between minimum and maximum generator load (parameters 5762 ↗ p. 288 &amp; 5763 ↗ p. 288) after the new genset has been started.</p> <p><b>Stopping genset</b></p> <p>The load on the remaining gensets must not exceed 50 % of the range between minimum and maximum generator load (parameters 5762 ↗ p. 288 &amp; 5763 ↗ p. 288).</p>
			High	<p><b>Starting genset</b></p> <p>A smaller genset is requested to operate the engines with higher efficiency. This may lead to more frequent starts and stops. The requested load is calculated so that the gensets will be loaded with 75 % of the range between minimum and maximum generator load (parameters 5762 ↗ p. 288 &amp; 5763 ↗ p. 288) after the new genset has been started.</p> <p><b>Stopping genset</b></p> <p>The genset will be shut down earlier. This may lead to more frequent starts and stops. The load on the remaining gensets must not exceed 75 % of the range between minimum and maximum generator load (parameters 5762 ↗ p. 288 &amp; 5763 ↗ p. 288).</p>

ID	Parameter	CL	Setting range [Default]	Description
				<p><b>Notes</b></p> <p>This parameter is only effective if start stop mode (parameter 5752 ↗ p. 285) is configured to "Generator load".</p> <p>Refer to parameter 5757 ↗ p. 289 for examples on stating and stopping a genset depending on the dynamic setting.</p>
5772	<b>MOP Add on delay</b>	2	0 to 32000 s [20 s]	<p>Load swings may exceed the threshold momentarily. In order to prevent the engine from starting due to short-term load swings, a delay time may be configured.</p> <p>The LDSS criterion for adding load must be exceeded without interruption for this delay time, configured in seconds, prior to a start command being issued.</p> <p>If the LDSS criterion for adding load is fallen below before the delay time expires, the delay time is reset and a start command is not issued.</p>
5773	<b>MOP Add on delay at rated load</b>	2	0 to 32000 s [3 s]	<p>The command to start the next genset in case a genset exceeds rated load will be issued after the delay configured here has expired.</p> <p>This parameter becomes only effective in case a genset exceeds rated load to achieve a faster start and overrides parameter 5772 ↗ p. 294.</p> <p><b>Notes</b></p> <p>This parameter becomes only effective in case a genset exceeds rated load to achieve a faster start and overrides parameter 5764 ↗ p. 291.</p>
5774	<b>MOP Add off delay</b>	2	0 to 32000 s [60 s]	<p>Load swings may fall below the threshold momentarily. In order to prevent the engine from stopping due to short-term load swings, a delay time may be configured.</p> <p>The load must remain below the hysteresis setpoint without interruption for the delay time, configured in seconds, prior to a stop command being issued.</p> <p>If the load exceeds the hysteresis setpoint before the delay time expires, the delay time is reset and a stop command is not issued.</p>

#### 4.5.11.2 Critical Mode

The critical mode may be used to operate a fire engine pump or any other critical operation which does not allow a shutdown of the genset under any alarm conditions.

The LogicsManager is used to define the conditions that will enable the critical mode like a discrete input (for conditions and explanation of programming refer to ↗ Chapter 9.4.1 "LogicsManager Overview" on page 689).

#### Alarm classes

When critical mode is enabled the alarm classes are reclassified as follows:

	Alarm classes					
Normal operation	A	B	C	D	E	F
Critical mode	A	B	B	B	B	B

**Critical mode "On"**

A critical mode will be initiated/started once the critical mode operation LogicsManager output becomes TRUE (logic "1"). The "Critical mode" message is displayed on the display screen. If the engine is not already running, the controller will attempt to start the engine as configured (parameter 4102 ↗ p. 269). All shutdown alarms become warning messages (see above).

**Critical mode "Off"**

A critical mode will be interrupted/stopped once critical mode operation LogicsManager output becomes FALSE (logic "0") and the postrun time has expired. If the operation mode changes to STOP, this time will be considered as expired. With termination of the critical mode, a normal cool down is performed.



Refer to ↗ Chapter 9.4.3 "Logical Outputs" on page 693 for more information about the priorities of the logical outputs.

**4.5.11.2.1 Critical Operation At Busbar**

The aforementioned fire engine pump or other critical operation is connected to the busbar, i.e. it requires a closed GCB to be supplied by the generator during critical operation.

Parameter 4100 ↗ p. 300 (Close GCB in critical mode) should be configured to "Yes" and an external provision for load reduction should be provided. This ensures the pump operation of a sprinkler system.



Application and breaker transition mode remain as configured.  
A mains parallel operation is possible.



The GCB will not be closed if the load is supplied by the mains until the mains fail and the MCB remains closed because emergency run (parameter 2802 ↗ p. 277) is disabled.

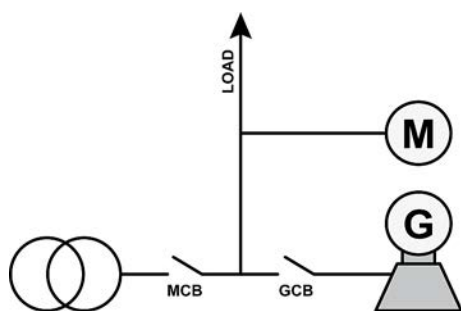

Fig. 98: Critical operation at busbar

**Critical mode during mains supply**

If critical mode is enabled during mains supply (MCB is closed), the generator will be started (if not already running) and the GCB will be closed.

- The "Critical mode" message is displayed on the display screen. All shutdown alarms become warning messages.
- If critical mode is disabled again, all shutdown alarms become active again.

If the genset was not running before critical mode has been enabled, it will be stopped after the critical mode postrun time (parameter 4102 ↗ p. 269) has expired. MCB operation will be performed according to the configured transition mode.

### Emergency power during critical mode

If there is a mains failure during critical mode, the "Emerg/Critical" message is displayed on the display screen after the mains fail delay time (parameter 2800 ↪ p. 277) has expired.

All shutdown alarms become warning messages.

- Critical mode ends before mains recovery:
  - The emergency power operation will be continued and all shutdown alarms become active again.
  - If the mains return, the unit transfers the load from generator supply to mains supply after the mains settling delay expires.
- Emergency power operation ends before the end of the critical mode:
  - The critical mode is maintained and the load is transferred from generator supply to mains supply after the mains settling delay expires.
  - If open transition mode is configured, the GCB will not be opened to prevent a dead busbar.
  - The engine remains running until the conditions for the critical mode are no longer existent.
  - If the genset was not running before critical mode has been enabled, it will be stopped after cool down time (parameter 3316 ↪ p. 271) has expired.
  - The GCB will take on the same state as it has before the critical mode has been enabled.

### Critical mode during emergency power

An emergency power operation is active (load is supplied by the generator, GCB is closed, MCB is open). If critical mode is enabled now, the GCB remains closed and the "Emerg/Critical" message is displayed on the display screen. All shutdown alarms become warning messages.

- Critical mode ends before mains recovery:
  - The emergency power operation will be continued and all shutdown alarms become active again.
  - If the mains return, the unit transfers the load from generator supply to mains supply after the mains settling delay expires, if Enable MCB (parameter 12923 ↪ p. 231) has been enabled.
- Emergency power operation ends before the end of the critical mode:
  - The critical mode is maintained and the load is transferred from generator supply to mains supply after the mains settling delay expires.
  - The engine remains running until the conditions for the critical mode are no longer existent.
  - If the genset was not running before critical mode has been enabled, it will be stopped after cool down time (parameter 3316 ↪ p. 271) has expired.
  - The GCB will take on the same state as it has before the critical mode has been enabled.

### Start request during critical mode

The critical mode operation has priority than the remote request (Start/Stop request in AUTO). Therefore, the remote request cannot start or stop the engine and has no effect on the breaker positions. The "Critical mode" message is displayed on the display screen and all shutdown alarms become warning alarms.



- Critical mode ends before the start request is terminated:
  - The engine continues running. All shutdown alarms will become active again.
  - By resetting the start request the GCB will be opened and the engine will be stopped.
- Start request will be terminated before the critical mode is terminated:
  - The critical mode operation is continued.
  - The engine keeps running until the conditions for the critical mode are no longer fulfilled and all shutdown alarms will become active again.
  - If the genset was not running before critical mode has been enabled, it will be stopped after cool down time (parameter 3316 ↗ p. 271) has expired.
  - The GCB will take on the same state as it has before the critical mode has been enabled.

#### 4.5.11.2.2 Critical Operation At The Generator

The aforementioned fire engine pump or other critical operation is connected to the generator, i.e. it does not require a closed GCB to be supplied by the generator during critical operation.

Parameter 4100 ↗ p. 300 (Close GCB in critical mode) should be configured to "No". This ensures an open GCB during critical mode. A closed GCB is possible in case of an emergency operation.

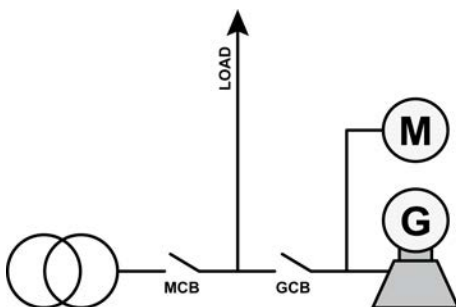

Fig. 99: Critical operation at the generator

#### Critical mode during mains supply

If critical mode is enabled during mains supply (MCB is closed), the generator will be started (if not already running) and operated with open GCB. The "Critical mode" message is displayed on the display screen. All shutdown alarms become warning messages.

If critical mode is disabled again, all shutdown alarms become active again. If the genset was not running before critical mode has been enabled, it will be stopped after the critical mode postrun time (parameter 4102 ↗ p. 269) has expired.

#### Emergency power during critical mode

If there is a mains failure during critical mode, the MCB will be opened after the mains fail delay time (parameter 2800 ↗ p. 277) has expired and the GCB will be closed. It is not necessary to configure parameter 4101 ↗ p. 278 (Break emerg. in critical mode) because the critical operation is already supplied. The "Emerg/Critical" message is displayed on the display screen and all shutdown alarms become warning messages.

- Critical mode ends before mains recovery:
  - The emergency power operation will be continued and all shutdown alarms become active again.
  - If the mains return, the unit transfers the load from generator supply to mains supply after the mains settling delay expires.
- Emergency power operation ends before the end of the critical mode:
  - The critical mode is maintained and the load is transferred from generator supply to mains supply after the mains settling delay expires.
  - The GCB will be opened without unloading (transition mode interchange or parallel).
  - All shutdown alarms become active again.
  - If the genset was not running before critical mode has been enabled, it will be stopped after cool down time (parameter 3316 ↪ p. 271) has expired.

### Critical mode during emergency power

An emergency power operation is active (load is supplied by the generator, GCB is closed, MCB is open). If critical mode is enabled now, the GCB will be opened dependent on the setting of the parameter 4101 ↪ p. 278 (Break emerg. in critical mode) and a closure of the GCB is prevented for this time. The "Emerg/Critical" message is displayed on the display screen and all shutdown alarms become warning messages.

- Critical mode ends before mains recovery:
  - The emergency power operation will be continued and all shutdown alarms become active again.
  - If the mains return, the unit transfers the load from generator supply to mains supply after the mains settling delay expires.
- Emergency power operation ends before the end of the critical mode:
  - The critical mode is maintained and the load is transferred from generator supply to mains supply after the mains settling delay expires.
  - The GCB will be opened without unloading (transition mode interchange or parallel).
  - All shutdown alarms become active again.
  - If the genset was not running before critical mode has been enabled, it will be stopped after cool down time (parameter 3316 ↪ p. 271) has expired.

### Start request during critical mode

The critical mode operation has priority than the remote request (Start/Stop request in AUTO). Therefore, the remote request cannot start or stop the engine and has no effect on the breaker positions. The "Critical mode" message is displayed on the display screen and all shutdown alarms become warning alarms.

- Critical mode ends before the start request is terminated:
  - The engine continues running and a change to generator or parallel operation is performed.
  - All shutdown alarms will become active again.
- Start request will be terminated before the critical mode is terminated:
  - The critical mode operation is continued. The engine keeps running until the conditions for the critical mode are no longer fulfilled and all shutdown alarms will become active again.
  - If the genset was not running before critical mode has been enabled, it will be stopped after cool down time (parameter 3316 ↪ p. 271) has expired.
  - The GCB will take on the same state as it has before the critical mode has been enabled.

**Critical mode during start request**

The generator supplies the load and the GCB is closed. If critical mode is enabled, the MCB will be operated according to the configured transition mode (parameter 3411 ↪ p. 223). The GCB will be opened without unloading (transition mode interchange or parallel). The "Critical mode" message is displayed on the display screen and all shutdown alarms become warning alarms.

- Critical mode ends before the start request is terminated:
  - The engine continues running and a change to generator or parallel operation is performed.
  - All shutdown alarms will become active again.
- Start request will be terminated before the critical mode is terminated:
  - The critical mode operation is continued.
  - The engine keeps running until the conditions for the critical mode are no longer fulfilled and all shutdown alarms will become active again.
  - If the genset was not running before critical mode has been enabled, it will be stopped after cool down time (parameter 3316 ↪ p. 271) has expired.

**Critical mode during isolated operation**

The busbar is supplied by the generator and emergency run (parameter 2802 ↪ p. 277) is disabled. If the critical mode is enabled, the GCB will be opened although the MCB is not enabled. This will cause a dead busbar.

**4.5.11.2.3 Parameters**

ID	Parameter	CL	Setting range [Default]	Description
12220	<b>Critical mode</b>	2	Determined by LogicsManager  [[0 & !05.08] & !09.01]	If this logical output becomes TRUE in AUTOMATIC operating mode, it starts the critical mode.
				<p><b>Notes</b></p> <p>For information on the LogicsManager and its default settings see ↪ Chapter 9.4.1 "LogicsManager Overview" on page 689.</p>

ID	Parameter	CL	Setting range [Default]	Description
4109	<b>Critical mode postrun</b>	2	0 to 6000 s [600 s]	The critical mode operation is continued for the time configured here after the critical mode request has been terminated.  The message "Cool down" is displayed and the LogicsManager command variable 04.10 becomes TRUE.
4100	<b>Close GCB in critical mode</b>	2	Yes	If a critical mode operation is detected the GCB will close.
			[No]	The GCB cannot be closed during a critical mode operation.
			<b>Notes</b> This parameter <b>only</b> applies to application mode <b>A03</b> <b>A04</b> .	
4105	<b>Override alarmcl. also in MAN</b>  (Critical mode alarm classes active in MANUAL operating mode )	2	Yes	The critical mode alarm classes will override the normal operation alarm classes when in MANUAL operation mode and the LogicsManager output 12220 ↪ p. 299 becomes TRUE.
			[No]	The alarm classes will not be changed in the MANUAL operating mode.

#### 4.5.12 Configure Controller



**WARNING!**

**Hazards due to incorrect settings**

The following parameters dictate how the easYgen controls voltage, frequency, load and power factor.

Failure to do so may lead to incorrect measurements and failures within the control unit resulting in damage to or destruction of the generator and/or personal injury or death.

- Always ensure that the correct settings are entered in these parameters.

The Real load, reactive load, and process control all utilize PID controllers. The response of each control loop can be adjusted for optimum response, however it is important to understand what a PID controller is and the effect of each controller adjustment has on the controller response.

Proportional gain, integral gain (stability) and DR (speed derivative ratio) are the adjustable and interacting parameters used to match the response of the control loop with the response of the system.

They correspond to the P (proportional), I (integral), and D (derivative) terms, and are displayed in the easYgen as follows:

- P - Proportional gain (%)
- I - Integral gain (%)
- D - Derivative gain (determined by DR and I)

**Proportional control**

Proportional response is directly proportional to a process change.

- **Analogy:** Setting hand throttle to keep constant speed on straight and level road.

Proportional control (using the same analogy) results in a certain speed as long as the car is not subjected to any load change such as a hill. If a throttle is set to any particular setting, the speed of the car will remain constant as long as the car remains straight and level. If the car goes up a hill it will slow down. Of course, going down a hill the car would gain speed.

### Integral control

Integral compensates for process and setpoint load changes.

- **Analogy:** Cruise control maintains constant speed regardless of hills.

Integral, sometimes called reset, provides additional action to the original proportional response as long as the process variable remains away from the setpoint. Integral is a function of the magnitude and duration of the deviation. In this analogy the reset response would keep the car speed constant regardless of the terrain.

### Derivative

Derivative provides a temporary over-correction to compensate for long transfer lags and reduce stabilization time on process upsets (momentary disturbances). The behavior of the derivative parameter is shown in Fig. 100.

- **Analogy:** Accelerating into high speed lane with merging traffic.

Derivative, sometimes called "preact" or "rate", is very difficult to draw an accurate analogy to, because the action takes place only when the process changes and is directly related to the speed at which the process changes.

Merging into high speed traffic of a freeway from an "on" ramp is no easy task and requires accelerated correction (temporary over-correction) in both increasing and decreasing directions. The application of brakes to fall behind the car in the first continuous lane or passing gear to get ahead of the car in the first continuous lane is a derivative action.

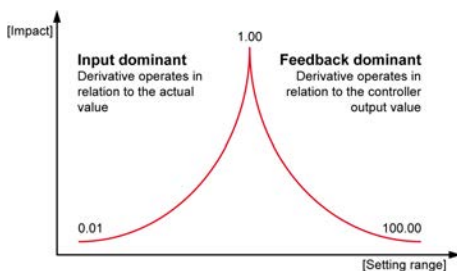

Fig. 100: Behavior of the derivative parameter

### PID tuning example

If the system is unstable, make sure the governor is the cause. This can be checked by closing the valve limiter until it has control of the actuator output. If the governor is causing the oscillation, time the oscillation cycle time. A rule-of-thumb is, if the system's oscillation cycle time is less than 1 second, reduce the Proportional gain term. A rule-of-thumb is, if the system's oscillation cycle time is greater than 1 second, reduce the Integral gain term (proportional gain may need to be increased also).

On an initial startup with the easYgen, all PID dynamic gain terms will require adjustment to match the respective PID's response to that of its control loop. There are multiple dynamic tuning methods available that can be used with the easYgen's PIDs to assist in determining the gain terms that provide optimum control loop response times.

The following method can be used to achieve PID gain values that are close to optimum:

1. ➤ Increase Derivative Ratio (DR) to 100.
2. ➤ Reduce integral gain to 0.01.

3.  Increase proportional gain until system just starts to oscillate.

 *The optimum gain for this step is when the system just starts to oscillate and maintains a self-sustaining oscillation that does not increase or decrease in magnitude.*

4.  Record the control gain (Kc) and oscillation period (T) in seconds.

5.  Set the dynamics as follows:

- For PI control  $G=P(I/s + 1)$  set:
    - Proportional gain =  $0.45 \cdot K_c$
    - Integral gain =  $1.2/T$
    - Derivative ratio = 100
  - For PID control  $G=P(I/s + 1 + Ds)$  set:
    - Proportional gain =  $0.60 \cdot K_c$
    - Integral gain =  $2/T$
    - Deriv ratio =  $8/(T \cdot \text{Integral Gain})$  for feedback dominant
    - Deriv ratio =  $(T \cdot \text{Integral Gain})/8$  for input dominant
- ⇒ This method of tuning will get the gain settings close, they can be fine-tuned from this point.

#### 4.5.12.1 Frequency Control



##### Notes on kick impulse function

Frequency control provides a kick impulse function, which issues a pulse if the frequency control deadband (parameter 5550  p. 304) is not exceeded and no synchronization could be performed for 20 seconds. The function is enabled, if a synchronization is carried out.

- If the phase angle is between 0° and 180°, a "frequency lower" signal is issued.
- If the phase angle is between 180° and 360°, a "frequency raise" signal is issued.

The pulse duration is 100ms. If the synchronization still fails, another pulse will be issued after 10 seconds.

The following conditions are required for the kick impulse function:

- Frequency control (parameter 5507  p. 302) is configured to "3pos controller"
- Synchronization mode (parameter 5728  p. 233) is configured to "RUN" or "CHECK" (or "Controlled by LM" and RUN or CHECK enabled by the LogicsManager)

ID	Parameter	CL	Setting range [Default]	Description
5507	Frequency control	2	[PID analog]	The frequency is controlled using an analog PID controller.
			3pos controller	The frequency is controlled using a three-step controller.
			Off	Frequency control is not carried out.
5508	Freq. control initial state	2	0.0 to 100.0 % [50.0 %]	The value entered for this parameter is the start reference point for the analog output to the speed controller.

ID	Parameter	CL	Setting range [Default]	Description
	(Frequency control initial state)			<p><b>Notes</b></p> <p>If the output to the speed control has been disabled, the output will act as a control position reference point.</p>
5510	<b>Proportional gain</b>	2	0.01 to 100.00 [1.00]	<p>The proportional coefficient specifies the gain. By increasing the gain, the response is increased to permit larger corrections to the variable to be controlled.</p> <p>The farther outside tolerances the process is, the larger the response action is to return the process to the tolerance band.</p> <p><b>Notes</b></p> <p>If the gain is configured too high, the result is excessive overshoot/undershoot of the desired value.</p> <p>This parameter is only visible if frequency control (parameter 5507 ↗ p. 302) is configured to "PID analog".</p>
5511	<b>Integral gain</b>	2	0.01 to 100.00 [1.00]	<p>The integral gain identifies the I part of the PID controller.</p> <p>The integral gain corrects for any offset (between setpoint and process variable) automatically over time by shifting the proportioning band. Reset automatically changes the output requirements until the process variable and the setpoint are the same.</p> <p>This parameter permits the user to adjust how quickly the reset attempts to correct for any offset.</p> <p><b>Notes</b></p> <p>The integral gain constant must be greater than the derivative time constant. If the integral gain constant is too large, the engine will continually oscillate.</p> <p>If the integral gain constant is too small, the engine will take too long to settle at a steady state.</p> <p>This parameter is only visible if frequency control (parameter 5507 ↗ p. 302) is configured to "PID analog".</p>
5512	<b>Derivative ratio</b>	2	0.01 to 100.00 [0.01]	<p>The derivative ratio identifies the D part of the PID controller.</p> <p>By increasing this parameter, the stability of the system is increased. The controller will attempt to slow down the action of the actuator in an attempt to prevent excessive overshoot or undershoot. Essentially this is the brake for the process.</p> <p>This portion of the PID loop operates anywhere within the range of the process unlike reset.</p> <p><b>Notes</b></p> <p>This parameter is only visible if frequency control (parameter 5507 ↗ p. 302) is configured to "PID analog".</p> <p>The default configured controller acts like a PI controller what is the valid D part setting for systems with secondary controllers.</p>

ID	Parameter	CL	Setting range [Default]	Description
5550	<b>Deadband</b>	1	0.02 to 9.99 Hz  [0.08 Hz]	<p><b>Isolated operation</b></p> <p>The generator frequency is controlled in such a manner that the measured frequency does not deviate from the configured setpoint by more than the value configured in this parameter without the controller issuing a frequency raise/lower signal to the frequency control.</p> <p>This prevents unneeded wear on the frequency bias output control or the raise/lower relay contacts.</p> <p><b>Example</b></p> <ul style="list-style-type: none"> <li>■ If the frequency setpoint is 50 Hz and a deadband of 0.5 Hz is configured, the measured generator frequency must exceed 50.5 Hz (50 + 0.5) to issue a lower pulse or fall below 49.5 Hz (50 - 0.5) to issue a raise pulse.</li> </ul> <p><b>Synchronization</b></p> <p>The generator frequency is controlled in such a manner that the measured frequency does not deviate from the monitored reference (mains or busbar) frequency by more than the value configured in this parameter without the controller issuing a frequency raise/lower signal to the frequency control.</p> <p>This prevents unneeded wear on the frequency bias output control or the raise/lower relay contacts. The value configured for this parameter must be less than the value configured for the df max (maximum frequency differential) for synchronization.</p> <p><b>Notes</b></p> <p>This parameter is only visible if frequency control (parameter 5507 ↗ p. 302) is configured to "3pos controller".</p>
5551	<b>Time pulse minimum</b>	1	0.01 to 2.00 s  [0.05 s]	<p>A minimum pulse on time must be configured here.</p> <p>The shortest possible pulse time should be configured to limit overshoot of the desired speed reference point.</p> <p><b>Notes</b></p> <p>This parameter is only visible if frequency control (parameter 5507 ↗ p. 302) is configured to "3pos controller".</p>
5552	<b>Gain factor</b>	1	0.1 to 10.0  [5.0]	<p>The gain factor <math>K_p</math> influences the operating time of the relays.</p> <p>By increasing the number configured in this parameter, the operating time of the relay will be increased in response to a deviation from the frequency reference.</p> <p>By increasing the gain, the response is increased to permit larger corrections to the variable to be controlled. The farther out of tolerance the process is the larger the response action is to return the process to the tolerance band.</p> <p><b>Notes</b></p> <p>If the gain is configured too high, the result is excessive overshoot/undershoot of the desired value.</p> <p>This parameter is only visible if frequency control (parameter 5507 ↗ p. 302) is configured to "3pos controller".</p>
5553	<b>Expand deadband factor</b>	1	1.0 to 9.9  [1.0]	<p>If the measured generator frequency is within the deadband range (parameter 5550 ↗ p. 304) and the configured delay expand deadband time (parameter 5554 ↗ p. 305) expires, the deadband will be multiplied with the factor configured here.</p>



ID	Parameter	CL	Setting range [Default]	Description
				<p><b>Notes</b></p> <p>This parameter is only visible if frequency control (parameter 5507 ↗ p. 302) is configured to "3pos controller".</p>
5554	<b>Delay expand deadband</b>	1	1.0 to 9.9 s [2.0 s]	<p>The measured generator frequency must be within the deadband range for the time configured here in order to multiply the deadband with the factor configured in parameter 5553 ↗ p. 304.</p> <p><b>Notes</b></p> <p>This parameter is only visible if frequency control (parameter 5507 ↗ p. 302) is configured to "3pos controller".</p>
5518	<b>Frequency setpoint 1 source</b>	2	Determined by AnalogManager	<p>The Frequency setpoint 1 source may be selected from the available data sources.</p> <p>Though it is possible to select from all available data sources ( ↗ Chapter 9.3.1 "Data Sources" on page 671), only the following data sources may be used:</p>
			[05.01]	<p>Internal frequency setpoint 1</p> <p>Internal frequency control setpoint 1 (parameter 5500 ↗ p. 305) is used as setpoint 1</p>
			05.02	<p>Internal frequency setpoint 2</p> <p>Internal frequency control setpoint 2 (parameter 5501 ↗ p. 306) is used as setpoint 1</p>
			05.03	<p>Interface frequency setpoint</p> <p>The setpoint, which is transmitted via the interface, is used as setpoint</p>
			05.13	<p>Discrete raise/lower frequency</p> <p>The setpoint from the discrete raise/lower frequency function is used as setpoint</p>
			06.01	<p>Analog input 1</p> <p>Analog input 1 is used to control the setpoint</p>
			06.02	<p>Analog input 2</p> <p>Analog input 2 is used to control the setpoint</p>
			06.03	<p>Analog input 3</p> <p>Analog input 3 is used to control the setpoint</p>
5500	<b>Int. freq. control setpoint 1</b> (Internal frequency control setpoint 1)	0	15.00 to 85.00 Hz [50.00 Hz]	<p>The internal generator frequency setpoint 1 is defined in this screen.</p> <p>This value is the reference for the frequency controller when performing isolated and/or no-load operations.</p> <p>Generally 50 Hz or 60 Hz will be the values entered into this parameter. It is possible to enter a different value here.</p>

ID	Parameter	CL	Setting range [Default]	Description
5519	<b>Frequency setpoint 2 source</b>	2	Determined by AnalogManager	The Frequency setpoint 2 source may be selected from the available data sources.  Though it is possible to select from all available data sources ( <a href="#">↪ Chapter 9.3.1 "Data Sources" on page 671</a> ), only the following data sources may be used:
			05.01	Internal frequency setpoint 1  Internal frequency control setpoint 1 (parameter 5500 <a href="#">↪ p. 305</a> ) is used as setpoint 2
			<b>[05.02]</b>	Internal frequency setpoint 2  Internal frequency control setpoint 2 (parameter 5501 <a href="#">↪ p. 306</a> ) is used as setpoint 2
			05.03	Interface frequency setpoint  The setpoint, which is transmitted via the interface, is used as setpoint
			05.13	Discrete raise/lower frequency  The setpoint from the discrete raise/lower frequency function is used as setpoint
			06.01	Analog input 1  Analog input 1 is used to control the setpoint
			06.02	Analog input 2  Analog input 2 is used to control the setpoint
			06.03	Analog input 3  Analog input 3 is used to control the setpoint
				<b>Notes</b>  Selecting a different data source may cause the controller to not operate properly.  The frequency setpoint may be adjusted within the configured operating limits ( <a href="#">↪ Chapter 4.4.1.1 "Generator Operating Voltage / Frequency" on page 110</a> ).
5501	<b>Int. freq. control setpoint 2</b>  (Internal frequency control setpoint 2)	0	15.00 to 85.00 Hz  <b>[50.00 Hz]</b>	The internal generator frequency setpoint 2 is defined in this screen.  This value is the reference for the frequency controller when performing isolated and/or no-load operations.  Generally 50 Hz or 60 Hz will be the values entered into this parameter. It is possible to enter a different value here.
12918	<b>Setpoint 2 freq.</b>  (Setpoint 2 frequency)	2	Determined by LogicsManager  <b>[(0 &amp; 1) &amp; 1]</b>	If this LogicsManager condition is TRUE, the frequency setpoint 2 will be enabled, i.e. the setting of parameter 5519 <a href="#">↪ p. 306</a> overrides the setting of parameter 5518 <a href="#">↪ p. 305</a> .  <b>Notes</b>  For information on the LogicsManager and its default settings see <a href="#">↪ Chapter 9.4.1 "LogicsManager Overview" on page 689</a> .
5516	<b>Start frequency control level</b>	1	15.00 to 85.00 Hz  <b>[47.00 Hz]</b>	The frequency controller is activated when the monitored generator frequency has exceeded the value configured in this parameter.  This prevents the easYgen from attempting to control the frequency while the engine is completing its start sequence.

ID	Parameter	CL	Setting range [Default]	Description
5517	<b>Start frequency control delay</b>	1	0 to 999 s [5 s]	The frequency controller is enabled after the configured time for this parameter expires.
5503	<b>Freq. control setpoint ramp</b> (Frequency control setpoint ramp)	2	0.10 to 60.00 Hz/s [2.50 Hz/s]	The different setpoint values are supplied to the controller via this ramp. The slope of the ramp is used to alter the rate at which the controller modifies the setpoint value. The faster the change in the setpoint is to be carried out, the greater the value entered here must be.
5504	<b>Frequency control droop</b>	2	0.0 to 20.0 % [2.0 %]	If this control is to be operated on a generator in parallel with other generators and frequency control is enabled, a droop characteristic curve must be used.  <b>Notes</b> Each generator in the system will require the same value to be configured for the droop characteristic, so that when the system is stable the active power will be distributed proportionally among all generators in relation to their rated power.
12904	<b>Freq. droop act.</b> (Frequency droop active)	2	Determined by LogicsManager [08.17 & 1] & 1]	If this LogicsManager condition is TRUE, the frequency droop is enabled.  <b>Notes</b> For information on the LogicsManager and its default settings see <a href="#">Chapter 9.4.1 "LogicsManager Overview" on page 689</a> . The active droop will also be sent to an ECU connected to the J1939 interface (CAN interface 2). This information is independent from the breaker states or active controller (frequency or power controller).  <b>Example</b> <ul style="list-style-type: none"> <li>■ Rated power: 500 kW</li> <li>■ Rated frequency setpoint: 50.0 Hz</li> <li>■ Droop 5.0%</li> <li>■ Active power: 0 kW = 0% of rated power Frequency is adjusted to: <math>(50.0 \text{ Hz} - [5.0\% * 0.0 * 50 \text{ Hz}]) = 50.0 \text{ Hz}</math>.</li> <li>■ Active power: +250 kW = +50% of rated power Frequency is adjusted to: <math>(50.0\text{Hz} - [5\% * 0.50 * 50 \text{ Hz}]) = 50.0 \text{ Hz} - 1.25 \text{ Hz} = 48.75 \text{ Hz}</math>.</li> <li>■ Active power: +500 kW = +100% of rated power Frequency is adjusted to: <math>(50.0\text{Hz} - [5\% * 1.00 * 50 \text{ Hz}]) = 50.0 \text{ Hz} - 2.5 \text{ Hz} = 47.50 \text{ Hz}</math>.</li> </ul>
5502	<b>Slip frequency setpoint offset</b>	2	0.00 to 0.50 Hz [0.10 Hz]	This value is the offset for the synchronization to the busbar/utility. With this offset, the unit synchronizes with a positive slip.  <b>Example</b> If this parameter is configured to 0.10 Hz and the busbar/mains frequency is 50.00 Hz, the synchronization setpoint is 50.10 Hz.  <b>Notes</b> The MCB can be synchronized with an individual slip frequency (also negative). The activation of MCB sync. with separate slip can be selected with parameter 5709 <a href="#">p. 230 (HMI: configuration   breakers   MCB)</a> hat comes with the MCB slip freq. setpoint offset parameter 5647 <a href="#">p. 230 (HMI: configuration   application   controller   frequency)</a> .

ID	Parameter	CL	Setting range [Default]	Description
5505	Phase matching gain	2	1 to 99 [5]	The phase matching gain multiplies the setting of the proportional gain (parameter 5510 ↗ p. 303) for phase matching control.
5506	Phase matching df-start	2	0.02 to 0.25 Hz [0.05 Hz]	Phase matching will only be enabled if the frequency difference between the systems to be synchronized is below the configured value.
12909	Release f-control	2	Determined by LogicsManager [[1 & 1) & 1]	<p>This LogicsManager is used to activate generally the frequency biasing to the sub controller. If the LogicsManager is false the output will be on the initial state (see parameter 5508 ↗ p. 302).</p> <p>The LogicsManager condition status 'TRUE' is activating the frequency or power regulation according to the LogicsManager 'F/P control' ID 12940 ↗ p. 314).</p> <p><b>Notes</b></p> <p>For information on the LogicsManager and its default settings see ↗ Chapter 9.4.1 "LogicsManager Overview" on page 689.</p>

4.5.12.2 Load Control



**NEW additional ramp can be used after mains decoupling (BDEW)**

With parameter 5014 ↗ p. 312 it is possible to follow the BDEW requirement ramping slower after mains decoupling.

Default ramping is backward compatible because parameter 5015 ↗ p. 313 per default comes with zero.



**NEW LogicsManager to disable all load ramps (BDEW)**

With LogicsManager 11465 ↗ p. 313 It is possible to activate the fastest load ramp e.g., for test.

ID	Parameter	CL	Setting range [Default]	Description
5525	Load Control	2	[PID analog]	The generator load is controlled using an analog PID controller.
			3pos controller	The generator load is controlled using a three-step controller.
			Off	Load control is not carried out.
5513	Proportional gain	2	0.01 to 100.00 [1.00]	<p>The proportional coefficient specifies the gain. By increasing the gain, the response is increased to permit larger corrections to the variable to be controlled.</p> <p>The farther out of tolerance the process is the larger the response action is to return the process to the tolerance band.</p>

ID	Parameter	CL	Setting range [Default]	Description
				<p><b>Notes</b></p> <p>If the gain is configured too high, the result is excessive overshoot/undershoot of the desired value.</p> <p>This parameter is only visible if load control (parameter 5525 ↗ p. 308) is configured to "PID analog".</p>
5514	<b>Integral gain</b>	2	0.01 to 100.00 <b>[1.00]</b>	<p>The integral gain identifies the I part of the PID controller.</p> <p>The integral gain corrects for any offset (between setpoint and process variable) automatically over time by shifting the proportioning band.</p> <p>Reset automatically changes the output requirements until the process variable and the setpoint are the same.</p> <p>This parameter permits the user to adjust how quickly the reset attempts to correct for any offset.</p> <p><b>Notes</b></p> <p>The integral gain constant must be greater than the derivative time constant. If the integral gain constant is too large, the engine will continually oscillate.</p> <p>If the integral gain constant is too small, the engine will take too long to settle at a steady state.</p> <p>This parameter is only visible if load control (parameter 5525 ↗ p. 308) is configured to "PID analog".</p>
5515	<b>Derivative ratio</b>	2	0.01 to 100.00 <b>[0.01]</b>	<p>The derivative ratio identifies the D part of the PID controller.</p> <p>By increasing this parameter, the stability of the system is increased. The controller will attempt to slow down the action of the actuator in an attempt to prevent excessive overshoot or undershoot. Essentially this is the brake for the process.</p> <p>This portion of the PID loop operates anywhere within the range of the process unlike reset.</p> <p><b>Notes</b></p> <p>This parameter is only visible if load control (parameter 5525 ↗ p. 308) is configured to "PID analog".</p> <p>The default configured controller acts like a PI controller what is the valid D part setting for systems with secondary controllers.</p>
5560	<b>Deadband</b>	1	0.10 to 9.99% <b>[1.00%]</b>	<p>The generator load is controlled in such a manner, when paralleled with the mains, so that the monitored load does not deviate from the configured load setpoint by more than the value configured in this parameter without the controller issuing a raise/lower signal to the speed control.</p> <p>This prevents unneeded wear on the raise/lower relay contacts. The configured percentage for the dead band refers to the generator rated active power (parameter 1752 ↗ p. 95).</p> <p><b>Notes</b></p> <p>This parameter is only visible if load control (parameter 5525 ↗ p. 308) is configured to "3pos controller".</p>
5561	<b>Time pulse minimum</b>	1	0.01 to 2.00 s <b>[0.05 s]</b>	<p>A minimum pulse on time must be configured here.</p> <p>The shortest possible pulse time should be configured to limit overshoot of the desired speed reference point.</p>

## Configuration

Configure Application > Configure Controller > Load Control

ID	Parameter	CL	Setting range [Default]	Description
				<p><b>Notes</b></p> <p>This parameter is only visible if load control (parameter 5525 ↗ p. 308) is configured to "3pos controller".</p>
5562	<b>Gain factor</b>	1	0.1 to 10.0  [5.0]	<p>The gain factor <math>K_p</math> influences the operating time of the relays.</p> <p>By increasing the number configured in this parameter, the operating time of the relay will be in-creased in response to a deviation from the frequency reference.</p> <p>By increasing the gain, the response is increased to permit larger corrections to the variable to be controlled. The farther out of tolerance the process is the larger the response action is to return the process to the tolerance band.</p> <p><b>Notes</b></p> <p>If the gain is configured too high, the result is excessive overshoot/undershoot of the desired value.</p> <p>This parameter is only visible if load control (parameter 5525 ↗ p. 308) is configured to "3pos controller".</p>
5563	<b>Expand dead-band factor</b>	1	1.0 to 9.9  [1.0]	<p>If the measured generator load is within the deadband range (parameter 5560 ↗ p. 309) and the configured delay expand deadband time (parameter 5564 ↗ p. 310) expires, the deadband will be multiplied with the factor configured here.</p> <p><b>Notes</b></p> <p>This parameter is only visible if load control (parameter 5525 ↗ p. 308) is configured to "3pos controller".</p>
5564	<b>Delay expand deadband</b>	1	1.0 to 9.9 s  [2.0 s]	<p>The measured generator load must be within the deadband range for the time configured here in order to multiply the deadband with the factor configured in parameter 5563 ↗ p. 310.</p> <p><b>Notes</b></p> <p>This parameter is only visible if load control (parameter 5525 ↗ p. 308) is configured to "3pos controller".</p>
5539	<b>Load setpoint 1 source</b>	2	Determined by AnalogManager  [05.04]  05.05  05.06  05.14  06.01	<p>The load setpoint 1 source may be selected from the available data sources. Though it is possible to select from all available data sources ( ↗ <i>Chapter 9.3.1 "Data Sources" on page 671</i>), only the following data sources may be used:</p> <p>Internal load setpoint 1 Internal load control setpoint 1 (parameter 5520 ↗ p. 311) is used as setpoint 1</p> <p>Internal load setpoint 2 Internal load control setpoint 2 (parameter 5501 ↗ p. 306) is used as setpoint 2</p> <p>Interface load setpoint The setpoint, which is transmitted via the interface, is used as setpoint</p> <p>Discrete raise/lower load The setpoint from the discrete raise/lower load function is used as setpoint</p> <p>Analog input 1 Analog input 1 is used to control the setpoint</p>

ID	Parameter	CL	Setting range [Default]	Description
			06.02	Analog input 2 Analog input 2 is used to control the setpoint
			06.03	Analog input 3 Analog input 3 is used to control the setpoint
				<b>Notes</b> Selecting a different data source may cause the controller to not operate properly. The load setpoint may be adjusted between 0 and the configured load control setpoint maximum (parameter 5523 ↗ p. 313).
5526	Load setpoint 1	2	Import	The value entered for the import level shall always be supplied by the utility. All load swings are absorbed by the generator(s) provided the load rating for the generator(s) is not exceeded. The generator will always start when an import power operation is enabled.
			Export	The value entered for the export level shall always be supplied to the utility. All load swings are absorbed by the generator(s) provided the load rating for the generator(s) is not exceeded. The generator will always start when an export power operation is enabled.
			[Constant]	The generator shall always supply the value entered for the constant power level. All load swings are absorbed by the utility. The generator will always start when a constant power (base load) operation is enabled.
5520	Int. load control setpoint 1 (Internal load control setpoint 1)	0	0.0 to 9999.9 kW [100.0 kW]	The load setpoint 1 is defined in this screen. This value is the reference for the load controller when performing parallel operations.
5540	Load setpoint 2 source	2	Determined by AnalogManager	The load setpoint 2 source may be selected from the available data sources. Though it is possible to select from all available data sources ( ↗ Chapter 9.3.1 "Data Sources" on page 671), only the following data sources may be used:
			05.04	Internal load setpoint 1 Internal load control setpoint 1 (parameter 5520 ↗ p. 311) is used as setpoint 2
			[05.05]	Internal load setpoint 2 Internal load control setpoint 2 (parameter 5527 ↗ p. 312) is used as setpoint 2
			05.06	Interface load setpoint The setpoint, which is transmitted via the interface, is used as setpoint
			05.14	Discrete raise/lower load The setpoint from the discrete raise/lower load function is used as setpoint
			06.01	Analog input 1 Analog input 1 is used to control the setpoint
			06.02	Analog input 2 Analog input 2 is used to control the setpoint

## Configuration

Configure Application > Configure Controller > Load Control

ID	Parameter	CL	Setting range [Default]	Description
			06.03	Analog input 3 Analog input 3 is used to control the setpoint
				<p><b>Notes</b></p> <p>Selecting a different data source may cause the controller to not operate properly.</p> <p>The load setpoint may be adjusted between 0 and the configured load control setpoint maximum (parameter 5523 ↗ p. 313).</p>
5527	<b>Load setpoint 2</b>	2	Import	The value entered for the import level shall always be supplied by the utility. All load swings are absorbed by the generator(s) provided the load rating for the generator(s) is not exceeded. The generator will always start when an import power operation is enabled.
			Export	The value entered for the export level shall always be supplied to the utility. All load swings are absorbed by the generator(s) provided the load rating for the generator(s) is not exceeded. The generator will always start when an export power operation is enabled.
			[Constant]	The generator shall always supply the value entered for the constant power level. All load swings are absorbed by the utility. The generator will always start when a constant power (base load) operation is enabled.
5521	<b>Int. load control setpoint 2</b> (Internal load control setpoint 2)	0	0.0 to 9999.9 kW [200.0 kW]	The load setpoint 2 is defined in this screen. This value is the reference for the load controller when performing parallel operations.
12919	<b>Setp. 2 load</b> (Setpoint 2 load)	2	Determined by LogicsManager [[0 & 1] & 1]	<p>If this LogicsManager condition is TRUE, the frequency setpoint 2 will be enabled, i.e. the setting of parameter 5540 ↗ p. 311 overrides the setting of parameter 5539 ↗ p. 310.</p> <p><b>Notes</b></p> <p>For information on the LogicsManager and its default settings see ↗ <i>Chapter 9.4.1 "LogicsManager Overview" on page 689.</i></p>
5522	<b>Load control setpoint ramp</b>	2	0.10 to 100.0 %/s [3.00 %/s]	The different setpoint values are supplied to the controller via this ramp. The slope of the ramp is used to alter the rate at which the controller modifies the setpoint value. The faster the change in the setpoint is to be carried out, the greater the value entered here must be.
				<p><b>Notes</b></p> <p>This ramp is also used in isolated operation for loading or unloading an additional genset. An excessive oscillation may occur if the ramp is configured too high.</p>
5014	<b>Load control ramp decoupling</b>	2	0.01 to 100.0 %/s [0.15 %/s]	The different setpoint values are supplied to the controller via this ramp. The slope of the ramp is used to alter the rate at which the controller modifies the setpoint value.



ID	Parameter	CL	Setting range [Default]	Description
				<p><b>Notes</b></p> <p>This second load control ramp (decoupling) rate for active power control is requested by BDEW. The percentage value is related to the generator rated power. If the actual active power setpoint is reached, the ramp is no longer valid but the "original" setpoint ramp 5522 is used.</p> <p>Parameter 5015 ↗ p. 313 defines the time the ramp rate is valid after mains decoupling.</p> <p>This ramp isn't active during unloading.</p>
5015	Time until setpoint ramp reset	2	0 to 9999 s [0 s]	<p>The mains decoupling ramp (2nd load ramp) will be disabled after that time delay.</p> <p><b>Notes</b></p> <p>This parameter comes with default zero for backward compatibility (2nd load ramp disabled). BDEW prefers 600 s.</p>
11465	Enable test ramp	2	Determined by LogicsManager [[00.01& 1] & 1]	<p>The LogicsManager can be used to perform fastest possible load ramp independent from load ramp settings.</p> <p>If this LogicsManager condition is TRUE and load ramp will be performed, it will be the fastest possible.</p>
5523	Load control setpoint maximum	2	0 to 150% [100%]	<p>If the maximum generator load is to be limited, a percentage based on the rated generator power (parameter 1752 ↗ p. 95) must be entered here. The controller adjusts the generator in such a manner that this value is not exceeded. This parameter limits the setpoint of the load controller when the generator is in a mains or island parallel operation.</p>
3465	Minimum gen. power	2	0 to 100% [0%]	<p>If the load controller is active, the generator operates with the configured minimum generator power, even if the actual active power setpoint is lower than that parameter value.</p> <p>This parameter isn't used during the unloading sequence.</p>
5524	Minimum gen. import/export	2	0 to 100% [0%]	<p>If the minimum generator load is to be limited, a percentage based on the rated generator power (parameter 1752 ↗ p. 95) must be entered here. The controller will not permit the load to drop below the configured load limit value.</p> <p>This parameter is only functional when the generator is in a mains parallel operation.</p>
5532	Warm up load limit	2	0 to 100% [15%]	<p>The maximum load is limited to this percentage of the generator rated power (parameter 1752 ↗ p. 95) until the warm up time (parameter 5534 ↗ p. 313) has expired or the warm up temperature threshold (parameter 5546 ↗ p. 314) has been exceeded.</p>
5534	Warm up time	2	0 to 9999 s [0 s]	<p>The maximum load is limited to the value configured in parameter 5532 ↗ p. 313 for the time configured here.</p> <p><b>Notes</b></p> <p>This parameter is only effective if Warm up mode (parameter 5533 ↗ p. 313) is configured to "Time controlled".</p>
5533	Warm up mode	2	Analog val contr [Time controlled]	<p>The maximum load is limited to the value configured in parameter 5532 ↗ p. 313 until the temperature measured according to the setting in parameter 5538 ↗ p. 314 has exceeded the threshold configured in parameter 5546 ↗ p. 314.</p> <p>The maximum load is limited to the value configured in parameter 5532 ↗ p. 313 until the time configured in parameter 5534 ↗ p. 313 has expired.</p>

## Configuration

ID	Parameter	CL	Setting range [Default]	Description
5538	<b>Engine warm up criterion</b>	2	Determined by AnalogManager	The engine warm up criterion may be selected from the available data sources.  Though it is possible to select from all available data sources ( <a href="#">↪ Chapter 9.3.1 "Data Sources" on page 671</a> ), only the following data sources may be used:
			<b>[06.01]</b>	Analog input 1  Analog input 1 is used to control the setpoint
			06.02	Analog input 2  Analog input 2 is used to control the setpoint
			06.03	Analog input 3  Analog input 3 is used to control the setpoint
				<b>Notes</b>  Selecting a different data source may not allow the controller to operate properly.  This parameter is only effective if "Warm up mode" (parameter 5533 <a href="#">↪ p. 313</a> ) is configured to "Analog val contr".
5546	<b>Warm up threshold</b>	2	0 to 1000 °C <b>[80 °C]</b>	The maximum load is limited to the value configured in parameter 5532 <a href="#">↪ p. 313</a> until the temperature has exceeded the threshold configured here.
				<b>Notes</b>  This parameter is only effective if Warm up mode (parameter 5533 <a href="#">↪ p. 313</a> ) is configured to "Analog val contr".
12940	<b>F/P control</b>	2	Determined by LogicsManager  <b>[(04.07&amp; 04.06) &amp; 1]</b>	The LogicsManager can be used to control whether frequency control or active power control should be performed.  If this LogicsManager condition is TRUE, the active power control is performed.
5606	<b>Load setpoint 3 source</b>	2	Determined by AnalogManager	The load setpoint 3 source may be selected from the available data sources.  Though it is possible to select from all available data sources ( <a href="#">↪ Chapter 9.3.1 "Data Sources" on page 671</a> ), only the following data sources may be used:
			05.04	Internal load setpoint 1  Internal load control setpoint 1 (parameter 5520 <a href="#">↪ p. 311</a> ) is used as setpoint 2
			05.05	Internal load setpoint 2  Internal load control setpoint 2 (parameter 5527 <a href="#">↪ p. 312</a> ) is used as setpoint 2
			05.06	Interface load setpoint  The setpoint, which is transmitted via the interface, is used as setpoint
			05.14	Discrete raise/lower load  The setpoint from the discrete raise/lower load function is used as setpoint
			<b>[06.01]</b>	Analog input 1  Analog input 1 is used to control the setpoint

ID	Parameter	CL	Setting range [Default]	Description
			06.02	Analog input 2 Analog input 2 is used to control the setpoint
			06.03	Analog input 3 Analog input 3 is used to control the setpoint
				<b>Notes</b> Selecting a different data source may cause the controller to not operate properly. The load setpoint may be adjusted between 0 and the configured load control setpoint maximum (parameter 5523 ↗ p. 313).
12998	<b>Setp. 3load</b> (Setpoint 3 load)	2	Determined by LogicsManager [(0 & 1) & 1]	If this LogicsManager condition is TRUE, the frequency setpoint 3 will be enabled, i.e. the setting of parameter 5606 ↗ p. 314 overrides the setting of parameter 5539 ↗ p. 310 but setpoint 2 becomes priority.  <b>Notes</b> For information on the LogicsManager and its default settings see ↗ Chapter 9.4.1 "LogicsManager Overview" on page 689.
5796	<b>Load setpoint 3</b>	2	Import	The value entered for the import level shall always be supplied by the utility. All load swings are absorbed by the generator(s) provided the load rating for the generator(s) is not exceeded. The generator will always start when an import power operation is enabled.
			Export	The value entered for the export level shall always be supplied to the utility. All load swings are absorbed by the generator(s) provided the load rating for the generator(s) is not exceeded. The generator will always start when an export power operation is enabled.
			[Constant]	The generator shall always supply the value entered for the constant power level. All load swings are absorbed by the utility. The generator will always start when a constant power (base load) operation is enabled.
5795	<b>Int. load control setpoint 3</b> (Internal load control setpoint 3)	0	0.0 to 9999.9 kW [200.0 kW]	The load setpoint 3 is defined in this screen. This value is the reference for the load controller when performing parallel operations.
3465	<b>Min. Generator power</b>	1	0 to 100% [0%]	This is the minimum active power setpoint. Any lower other active power setpoint will be ignored!  <b>Notes</b> For backward compatibility reasons the default value is zero. This min. value is also used for the AnalogManager data sources ↗ Chapter 9.3.1.5 "Group 05: Controller Setpoints" on page 674  ■ 05.19 Used power setpoint without ramp and ■ 05.20 Used power setpoint with ramp

### 4.5.12.3 Derating (Uprating) Of Power

#### General notes

This set of functions is used to change the current active power setpoint:

- Direct derating
- Free derating
- J1939 (ECU) derating

The current active power setpoint can be set to any value offered by the Analog Manager in mains parallel operation. The unit is capable to derate power e.g. according to the standards of power supply companies and to uprate power e.g. for multiple engine control.

The function "Derating" offers free and direct derating. Direct derating has priority.

If Direct Derating is ON, uprating is possible by a percentage value higher than 100 of Analog Manager "Source free derating" output (parameter 15147 ↗ p. 320).



Refer to ↗ Chapter 6.4.15 "Ripple Control Receiver" on page 470 for a derating application example.

### Function

When the LogicsManagers "Direct derating" (parameter 15149 ↗ p. 320) is OFF, "Free derating" (parameter 15146 ↗ p. 320) becomes TRUE and the analog value of power exceeds the value "Start derating at" (parameter 15143 ↗ p. 320), the unit begins to reduce the present active power setpoint. The grade of reducing depends on the value "Stop derating at" (parameter 15144 ↗ p. 320) and the value of "Max. power deviation" (parameter 15145 ↗ p. 320) which are configurable. If the Logics-Manager "Free derating" becomes FALSE, the unit ramps back to its original setpoint. If derating/uprating is active, the display shows the indication "Derating"/"Uprating".

The derating/uprating function can be used in isolated operation, too. The available rated power from an engine can be reduced (derated) or increased (uprated) with an analog value without adjusting a parameter value. With this function the engine can be individually loaded within of an multiple gen isolated operation (asynchronous load sharing) .

### Applications

- Derating
  - A fire pump is mechanically connected to an engine by a clutch. In this case the engine provides a limited amount of electrical power for the load sharing.
  - An asynchronous load sharing is required. It should be possible to operate an engine with limited power (new engine or after maintenance).
- Uprating
  - Higher percentage loading of a particular engine for load tests.

### Example 1: Mains Parallel Operation (setpoint = below rated power)

- Rated generator power = 200 kW
- Current power setpoint of the generator = 150 kW (75%)
- Start derating at = 80 °C water temperature (i.e. analog input AI 01 is defined as free derating source by parameter15174)
- Stop derating at = 90 °C water temperature
- Max. power deviation = 40% (80 kW)

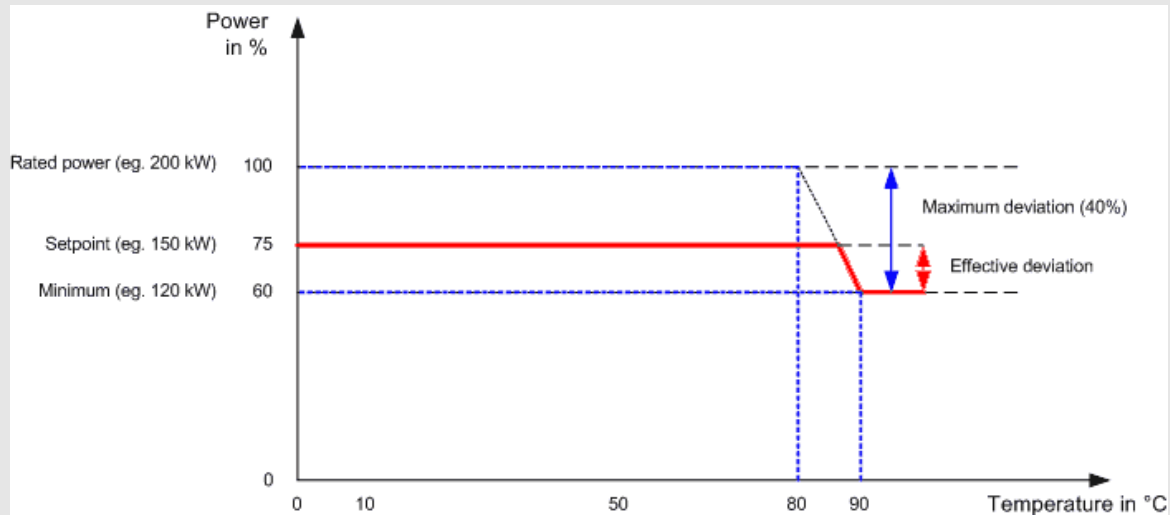

Fig. 101: Derating: Mains parallel operation; setpoint below rated power

If the engine is running and the LogicsManager "Free derating" is TRUE, the unit monitors the water temperature. If the water temperature remains below the value "Start derating at", the reduction becomes not active and remains on 0%. If the water temperature increases and so exceeds the value "Start derating at" the reduction becomes active (the unit starts to derate the current active power setpoint). The rate of reduction (slope) is determined by the values of "Start derating at", "Stop derating at", and "Max. power deviation" ("Max. power deviation" also defines the minimum power).

In the power reduction would increase and so reduce power from 75% at 86.5 °C down to 60% = 120 kW at 90 °C. Temperature over 90 °C would cause the same reduction of 40% in this example. So it is guaranteed that the engine is not running with too less load.

A Setpoint below the Minimum (e.g. 55%) would not run into reduction.

With a smaller Maximum deviation (e.g. 20%) Minimum would be higher than Setpoint and so not cause reduction.

**Example 2: Mains Parallel Operation (setpoint = rated power)**

- Rated generator power = 200 kW
- Current power setpoint of the generator = 200 kW (100%)
- Start derating at = 80 °C water temperature (i.e. analog input AI 02 is defined as free derating source by parameter15174)
- Stop derating at = 90 °C water temperature
- Max. power deviation = 40% (80 kW)

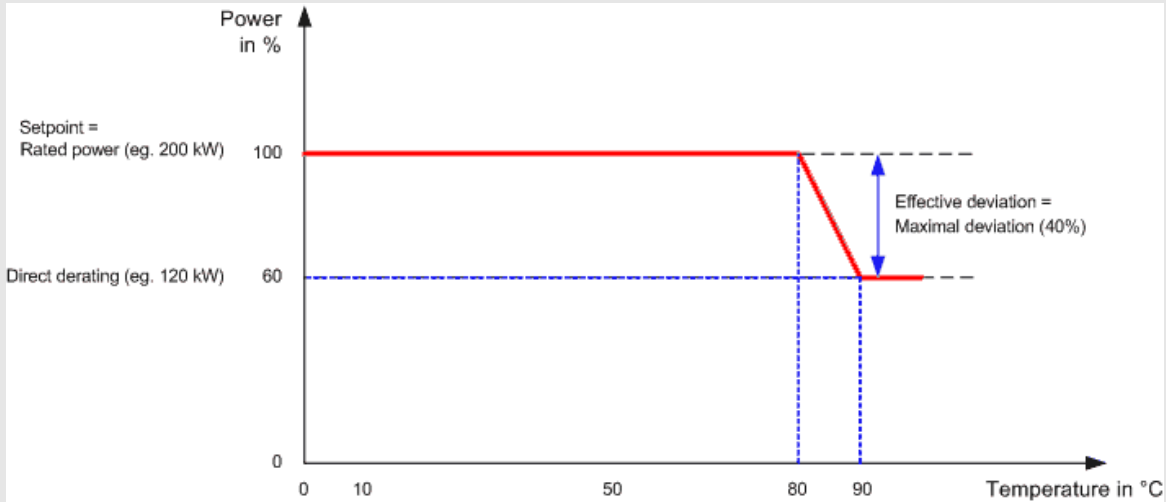

Fig. 102: Derating: Mains parallel operation; setpoint = rated power

If the engine is running and the LogicsManager "Free derating" is TRUE, the unit monitors the water temperature. If the water temperature remains below the value "Start derating at", the reduction becomes not active and remains on 0%. If the water temperature increases and so exceeds the value "Start derating at" the reduction becomes active (the unit starts to derate the current active power setpoint). The rate of reduction (slope) is determined by the values of "Start derating at", "Stop derating at", and "Max. power deviation" ("Max. power deviation" also defines the minimum power).

The power reduction would increase and so reduce power from 100% at 80 °C down to 60% = 120 kW at 90 °C. Temperature over 90 °C would cause the same reduction of 40% in this example. So it is guaranteed that the engine is not running with too less load.

**Example 3: Isolated Parallel Operation (IOP)**

- Rated generator power = 200 kW
- Current average utilization of all generators = 95%
- Start derating at = 80 °C water temperature (i.e. analog input AI 02 is defined as free derating source by parameter15174)
- Stop derating at = 90 °C water temperature
- Max. power deviation = 40%

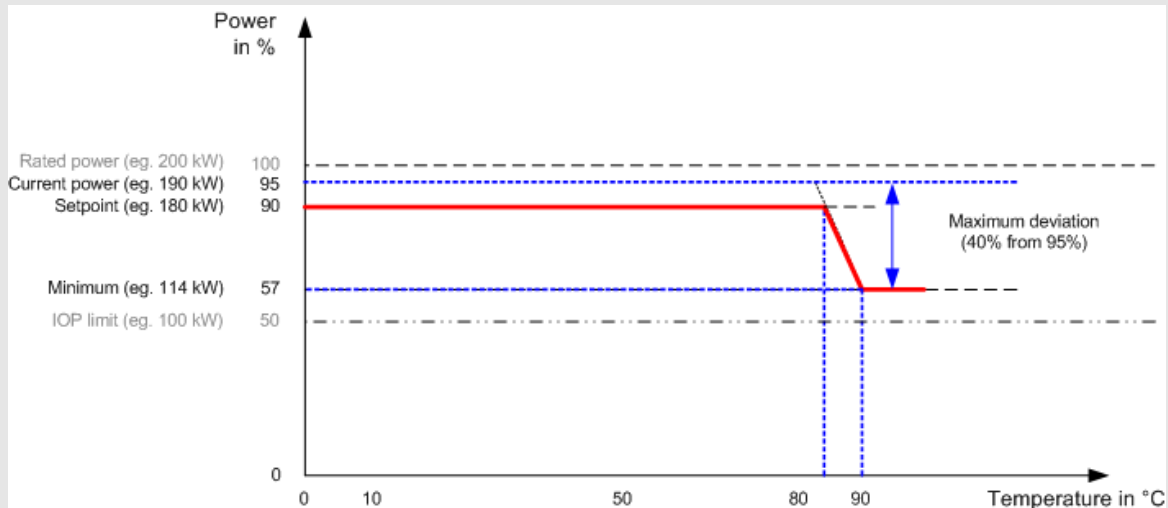

Fig. 103: Derating: Mains parallel operation in isolated parallel operation

In isolated parallel operation the derating factor is correlated to the utilization factor of all engines! This becomes the new Maximum for deration.

The engine is running with 90% (180 kW). If the LogicsManager is enabled and temperature has reached 80 °C the derating becomes effective (the unit starts to derate the current active power setpoint). If the temperature is 90 °C or higher the maximum reduction value of 40% becomes active. The current power of 95% will be reduced by 40% to 60% (of 95%).

$95\% \times 60\% = 57\%$ . This engine will run now with  $200 \text{ kW} \times 57\% = 200 \text{ kW} \times 0.57 = 114 \text{ kW}$ .



*In isolated parallel operation the derating is limited to 50%.*

*It is not possible to get the utilization factor lower than 50% by derating function.*



*If the derating signals are digital (e.g. different relay outputs), the digital signals can be transformed to an analog signals with a simple set of resistors.*



*The derating of power has an impact on the Load-Dependent Start/Stop functionality (refer to [Chapter 6.3.1 "Configuring Load-Dependent Start/Stop"](#) on page 427): The start of the next generator will be shifted.*

## Configuration

Configure Application > Configure Controller > Derating (Uprating) Of Pow...

ID	Parameter	CL	Setting range [Default]	Description
15143	<b>Start derating at</b>	2	-032000 to 032000 [1000]	This parameter defines the starting point when the derating becomes active. The value applies to the analog source (parameter 15147 ↗ p. 320).
15144	<b>Stop derating at</b>	2	-032000 to 032000 [0]	This parameter defines (in combination with parameter 15143 ↗ p. 320) the ramp of the derating function.
15145	<b>Max. power deviation</b>	2	1.0 to 100.0 % [100.0 %]	This parameter defines the maximal power deviation of the derating function. That means it determines also the minimal power while derating is active. The configured percentage for the max. power deviation refers to the generator rated active power (parameter 1752 ↗ p. 95).
15147	<b>Source free derating</b>	2	Analog Manager [Analog input AI 01]	This parameter defines the analog source which controls the derating function.
15146	<b>Free derating</b>	2	Determined by LogicsManager (24.60) [False]	This LogicsManager equation releases the free derating function.
15142	<b>ECU derating on/off</b>	2		To prevent knocking in the engine, some ECUs (Engine Control Unit) transmit a J1939 CAN message to derate the power (in percentage of rated power). The easYgen is able to accept this message and to derate the power according to this message. If derating is active, the display shows the indication "Derating".
			On	The derate command issued from the ECU via J1939 message is accepted.
			[Off]	The derate command via ECU is ignored.
15149	<b>Direct derating on/off</b>	2	On	Only the analog source is used for the up-/derating. The parameters 15143, 15144, and 15145 are not visible neither in the HMI nor in ToolKit.
			[Off]	The free derating function uses the parameters 15143, 15144, and 15145 for the calculation from the derating value. This parameters are visible in the HMI and ToolKit.

### Direct Derating

If parameter *Direct derating* (parameter 15149 ↗ p. 320) is configured to ON, the value of the Analog Manager equation 81.21 is interpreted as a percentage value the rated power has to be derated to.

For example: If this Analog Manager provides the value 60, the setpoint will be derated to 60% rated power (this means a deration of 40%).

### Uprating

If there are multiple engines running in some cases it is required that e.g., one engine is running with higher load than the others. **This can be adjusted by a Analog Manager output higher than 100% and *Direct derating* switched ON.**





**Indication**

If derating is active “Derating active” is shown in the status message and command variable 05.16 becomes active.

If uprating is active “Uprating active” is shown in the status message and command variable 05.17 becomes active

The value of derating(/uprating) is shown under [Setpoint / Derating]. In case of derating this value has positive sign in case of uprating it has negative sign.

**4.5.12.4 Frequency Depending Derating Of Power**

**General notes**

This controller function is supporting a dynamic stabilization of mains. Some grid codes require to derate the real power if the mains frequency increases to a value of e.g. 50.20 Hz ( $F_{Start}$ ). The derating is stopped, if the frequency becomes lower than e.g. 50.15 Hz ( $F_{Stop}$ ).

**Function**

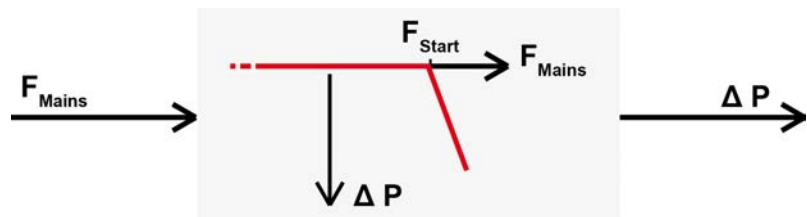

Fig. 104: Frequency depending derating of power (schematic)

If the frequency increases the value  $F_{Start}$  (Parameter 5782 ↪ p. 322), the momentary power of the generator will be memorized by the controller as an **internal** value  $P^M$ . Now the power will be derated with a gradient  $R$  [%/Hz] (parameter 5784 ↪ p. 323). The power derating is shown in Fig. 104.

**Example**

The power derating  $\Delta P$  may be calculated using the following formula:

$$\Delta P = P_M \text{ [kW]} \times R \text{ [%/Hz]} \times (F_{Mains} \text{ [Hz]} - F_{Start} \text{ [Hz]}) / 100 \text{ [%]}$$

The example uses the following values:

- $P_M = 130 \text{ kW}$
- $R = 40 \text{ \%/Hz}$  (parameter 5784 ↪ p. 323)
- $F_{Start} = 50.20 \text{ Hz}$  (parameter 5782 ↪ p. 322)
- $F_{Mains} = 50.50 \text{ Hz}$

The power derating  $\Delta P$  is calculated as follows:

- $\Delta P = 130 \text{ kW} \times 40 \text{ \%/Hz} \times (50.50 \text{ Hz} - 50.20 \text{ Hz}) / 100 \% = 15.6 \text{ kW}$
- The assumed frequency increases to 50.70 Hz:
- $\Delta P = 130 \text{ kW} \times 40 \text{ \%/Hz} \times (50.70 \text{ Hz} - 50.20 \text{ Hz}) / 100 \% = 26.0 \text{ kW}$

The derating becomes inactive, if the frequency becomes lower than  $F_{Stop}$  (Parameter 5783 ↪ p. 322). (If the frequency becomes too high, the frequency monitoring function trips.)

### Start conditions

The power derating function becomes active, if the following conditions are true:

- Mains frequency >  $F_{Start}$  (parameter 5782 ↪ p. 322) AND
- Mains parallel operation active (MCB and GCB are closed) AND
- easYgen is in AUTOMATIC mode AND
- The corresponding controller functions are switched "On"

### Stop conditions

The power derating function becomes inactive and will be reset, if at least one of the following conditions is true:

- Mains frequency <  $F_{Stop}$  (parameter 5783 ↪ p. 322) OR
- Mains parallel operation **not** active (MCB and GCB are open ) OR
- easYgen is **not** in AUTOMATIC mode OR
- The corresponding controller functions are switched "Off"

### Function behavior

If the frequency decreases, while the derating is still active, the behavior depends on parameter "Hold max.derating" (parameter 5785 ↪ p. 323).

#### Example

The following assumptions are made:

- The corresponding parameters are set to default
- Derating has started with  $F_{Start} = 50.20$  Hz with  $P_M = 130$  kW
- The current frequency is 50.70 Hz → reduction  $\Delta P = 26$  kW → current power = 104 kW

Now the measured frequency decreases to 50.50 Hz:

- "Hold max. derating" (parameter 5785 ↪ p. 323) = **Off** - The derating  $\Delta P$  decreases to 15.6 kW according to the gradient 40 %/Hz → the power is increasing to 114.4 kW.
- "Hold max. derating" (parameter 5785 ↪ p. 323) = **On** - The derating still remains at 26 kW → the power remains at 104 kW. During a active derating process, the power will never increase again. The power can only increase again if the derating becomes inactive, that means that the measured frequency has reached  $F_{Stop}$ .

ID	Parameter	CL	Setting range [Default]	Description
5781	Function	2	On	F/P load derating is switched on. The power will be derated, if the frequency becomes higher than "f start value" (parameter 5782 ↪ p. 322).
			[Off]	F/P load derating is switched off.
5782	f start value	2	15.00 to 85.00 Hz [50.20 Hz]	The derating function becomes active if the measured frequency becomes higher than this value.
5783	f stop value	2	15.00 to 85.00 Hz [50.15 Hz]	The derating function becomes inactive if the measured frequency becomes lower than this value.

ID	Parameter	CL	Setting range [Default]	Description
5784	f dep. derating	2	1 to 100 %/Hz [40 %/Hz]	This function works with the derating gradient defined here, if the derating function is active. The higher this value, the higher the derating.
5785	Hold max. derating	2	On	While the derating is still active, the power <b>never</b> increases again.
			[Off]	While the derating is still active, the power <b>can</b> increase according to the defined gradient, if the measured frequency becomes lower. (Even if the frequency is still higher than "f stop value" (parameter 5783 ↪ p. 322))

#### 4.5.12.5 Voltage Control

ID	Parameter	CL	Setting range [Default]	Description
5607	Voltage Control	2	[PID analog]	The voltage is controlled using an analog PID controller.
			3pos controller	The voltage is controlled using a three-step controller.
			Off	Voltage control is not carried out.
5608	Voltage control initial state	2	0.0 to 100.0% [50.0%]	The value entered for this parameter is the start reference point for the analog output to the voltage controller.  If the output to the voltage control has been disabled, the output will act as a control position reference point.
5610	Proportional gain	2	0.01 to 100.00 [1.00]	The proportional coefficient specifies the gain. By increasing the gain, the response is increased to permit larger corrections to the variable to be controlled. The farther out of tolerance the process is the larger the response action is to return the process to the tolerance band. If the gain is configured too high, the result is excessive overshoot/undershoot of the desired value.
				<b>Notes</b>  This parameter is only visible if voltage control (parameter 5607 ↪ p. 323) is configured to "PID analog".
5611	Integral gain	2	0.01 to 100.00 [1.00]	The integral gain identifies the I part of the PID controller. The integral gain corrects for any offset (between setpoint and process variable) automatically over time by shifting the proportioning band. Reset automatically changes the output requirements until the process variable and the setpoint are the same. This parameter permits the user to adjust how quickly the reset attempts to correct for any offset. The integral gain constant must be greater than the derivative time constant. If the integral gain constant is too large, the engine will continually oscillate. If the integral gain constant is too small, the engine will take too long to settle at a steady state.
				<b>Notes</b>  This parameter is only visible if voltage control (parameter 5607 ↪ p. 323) is configured to "PID analog".
5612	Derivative ratio	2	0.01 to 100.00 [0.01]	The derivative ratio identifies the D part of the PID controller. By increasing this parameter, the stability of the system is increased.  The controller will attempt to slow down the action of the actuator in an attempt to prevent excessive overshoot or undershoot.  Essentially this is the brake for the process. This portion of the PID loop operates anywhere within the range of the process unlike reset.

## Configuration

Configure Application > Configure Controller > Voltage Control

ID	Parameter	CL	Setting range [Default]	Description
				<p><b>Notes</b></p> <p>This parameter is only visible if voltage control (parameter 5607 ↗ p. 323) is configured to "PID analog".</p> <p>The default configured controller acts like a PI controller what is the valid D part setting for systems with secondary controllers.</p>
5650	<b>Deadband</b>	1	0.10 to 9.99% <b>[1.00%]</b>	<p><b>Isolated operation</b></p> <p>The generator voltage is controlled in such a manner that the measured voltage does not deviate from the configured setpoint by more than the value configured in this parameter without the controller issuing a voltage raise/lower signal to the voltage regulator. This prevents unneeded wear on the voltage bias output control or the raise/lower relay contacts.</p> <p><b>Synchronization</b></p> <p>The generator voltage is controlled in such a manner that the measured voltage does not deviate from the monitored reference (mains or busbar) voltage by more than the value configured in this parameter without the controller issuing a voltage raise/lower signal to the voltage regulator.</p> <p>This prevents unneeded wear on the voltage bias output control or the raise/lower relay contacts. The value configured for this parameter must be less than the value configured for the dV max (maximum voltage differential) for synchronization (parameters 5700 ↗ p. 226 or 5710 ↗ p. 230).</p>
				<p><b>Notes</b></p> <p>This parameter is only visible if voltage control (parameter 5607 ↗ p. 323) is configured to "3pos controller".</p>
5651	<b>Time pulse minimum</b>	1	0.01 to 2.00 s <b>[0.05 s]</b>	<p>A minimum pulse on time must be configured here. The shortest possible pulse time should be configured to limit overshoot of the desired voltage reference point.</p>
				<p><b>Notes</b></p> <p>This parameter is only visible if voltage control (parameter 5607 ↗ p. 323) is configured to "3pos controller".</p>
5652	<b>Gain factor</b>	1	0.1 to 10.0 <b>[5.0]</b>	<p>The gain factor Kp influences the operating time of the relays. By increasing the number configured in this parameter, the operating time of the relay will be in-creased in response to a deviation from the voltage reference.</p> <p>By increasing the gain, the response is increased to permit larger corrections to the variable to be controlled.</p> <p>The farther out of tolerance the process is the larger the response action is to return the process to the tolerance band. If the gain is configured too high, the result is excessive overshoot/undershoot of the desired value.</p>
				<p><b>Notes</b></p> <p>This parameter is only visible if voltage control (parameter 5607 ↗ p. 323) is configured to "3pos controller".</p>
5653	<b>Expand dead-band factor</b>	1	1.0 to 9.9 <b>[1.0]</b>	<p>If the measured generator voltage is within the deadband range (parameter 5650 ↗ p. 324) and the configured delay expand deadband time (parameter 5654 ↗ p. 325) expires, the deadband will be multiplied with the factor configured here.</p>
				<p><b>Notes</b></p> <p>This parameter is only visible if voltage control (parameter 5607 ↗ p. 323) is configured to "3pos controller".</p>

ID	Parameter	CL	Setting range [Default]	Description
5654	Delay expand deadband	1	1.0 to 9.9 s [2.0 s]	The measured generator voltage must be within the deadband range for the time configured here in order to multiply the deadband with the factor configured in parameter 5653 ↗ p. 324.
			<b>Notes</b> This parameter is only visible if voltage control (parameter 5607 ↗ p. 323) is configured to "3pos controller".	
5618	Voltage set-point 1 source	2	Determined by AnalogManager	The voltage setpoint 1 source may be selected from the available data sources.  Even it is possible to select all data sources ↗ Chapter 9.3.1 "Data Sources" on page 671), only the following data sources may be used:
			[05.07]	Internal voltage setpoint 1  Internal voltage control setpoint 1 (parameter 5600 ↗ p. 325) is used as setpoint 1
			05.08	Internal voltage setpoint 2  Internal voltage control setpoint 2 (parameter 5601 ↗ p. 326) is used as setpoint 1
			05.09	Interface voltage setpoint  The setpoint, which is transmitted via the interface, is used as setpoint
			05.15	Discrete raise/lower voltage  The setpoint from the discrete raise/lower voltage function is used as setpoint
			06.01	Analog input 1  Analog input 1 is used to control the setpoint
			06.02	Analog input 2  Analog input 2 is used to control the setpoint
			06.03	Analog input 3  Analog input 3 is used to control the setpoint
			<b>Notes</b> Selecting a different data source may not allow the controller to operate properly.  The voltage setpoint may be adjusted within the configured operating limits ( ↗ Chapter 4.4.1.1 "Generator Operating Voltage / Frequency" on page 110).	
			5600	Int.voltage control set-point 1
5619	Voltage set-point 2 source	2	Determined by AnalogManager	The voltage setpoint 2 source may be selected from the available data sources.  Even it is possible to select all data sources ↗ Chapter 9.3.1 "Data Sources" on page 671), only the following data sources may be used:
			05.07	Internal voltage setpoint 1  Internal voltage control setpoint 1 (parameter 5600 ↗ p. 325) is used as setpoint 2

ID	Parameter	CL	Setting range [Default]	Description
			[05.08]	Internal voltage setpoint 2 Internal voltage control setpoint 2 (parameter 5601 ↗ p. 326) is used as setpoint 2
			05.09	Interface voltage setpoint The setpoint, which is transmitted via the interface, is used as setpoint
			05.15	Discrete raise/lower voltage The setpoint from the discrete raise/lower voltage function is used as setpoint
			06.01	Analog input 1 Analog input 1 is used to control the setpoint
			06.02	Analog input 2 Analog input 2 is used to control the setpoint
			06.03	Analog input 3 Analog input 3 is used to control the setpoint
				<b>Notes</b> Selecting a different data source may not allow the controller to operate properly. The voltage setpoint may be adjusted within the configured operating limits ( ↗ Chapter 4.4.1.1 "Generator Operating Voltage / Frequency" on page 110).
5601	<b>Int.voltage control setpoint 2</b>	0	50 to 650,000 V [400 V]	The internal generator voltage setpoint 2 is defined in this screen. This value is the reference for the voltage controller when performing isolated and/or no-load operations.
12920	<b>Setp. 2 voltage</b>	2	Determined by LogicsManager [(0 & 1) & 1]	If this LogicsManager condition is TRUE, the voltage setpoint 2 will be enabled, i.e. the setting of parameter overrides the setting of parameter 5618 ↗ p. 325.
				<b>Notes</b> For information on the LogicsManager and its default settings see ↗ Chapter 9.4.1 "LogicsManager Overview" on page 689.
5616	<b>Start value</b>	1	0 to 100% [70%]	The voltage controller is activated when the monitored generator voltage has exceeded the value configured in this parameter. This prevents the easYgen from attempting to control the voltage while the engine is completing its start sequence.
				<b>Notes</b> This value refers to the generator voltage setpoint (parameter 5600 ↗ p. 325 or 5601 ↗ p. 326).
5617	<b>Start delay</b>	1	0 to 999 s [5 s]	The voltage controller is enabled after the configured time for this parameter expires.
5603	<b>Voltage control setpoint ramp</b>	2	1.00 to 300.00 %/s [5.00 %/s]	The different setpoint values are supplied to the controller via this ramp. The slope of the ramp is used to alter the rate at which the controller modifies the setpoint value. The faster the change in the setpoint is to be carried out, the greater the value entered here must be.

ID	Parameter	CL	Setting range [Default]	Description
5604	<b>Voltage control droop</b>	2	0.0 to 20.0% [5.0%]	<p>If this control is to be operated on a generator in parallel with other generators and voltage control is enabled, a droop characteristic curve must be used.</p> <p>Each generator in the system will require the same value to be configured for the droop characteristic, so that when the system is stable the reactive power will be distributed proportionally among all generators in relation to their rated reactive power.</p>
12905	<b>Volt. droop act.</b> (Voltage droop active)	2	Determined by LogicsManager [[08.17 & 1] & 1]	If this LogicsManager condition is TRUE, the voltage droop is enabled.
				<p><b>Example</b></p> <ul style="list-style-type: none"> <li>■ Rated reactive power: 400 kvar</li> <li>■ Rated voltage setpoint: 410 V</li> <li>■ Droop 5.0 %</li> <li>■ Reactive power 0 kvar = 0 % of rated power</li> <li>■ Voltage is adjusted to <math>(410\text{ V} - [5.0\% * 0.0 * 410\text{ V}]) = 410\text{ V}</math>.</li> <li>■ Reactive power 400 kvar = 100 % of rated reactive power</li> <li>■ Voltage is adjusted to <math>(410\text{ V} - [5.0\% * 1.0 * 410\text{ V}]) = 410\text{ V} - 20.5\text{ V} = 389.5\text{ V}</math>.</li> </ul>
				<p><b>Notes</b></p> <p>For information on the LogicsManager and its default settings see <a href="#">Chapter 9.4.1 "LogicsManager Overview" on page 689</a>.</p>
12938	<b>Release V-control</b>	2	Determined by LogicsManager [[1 & 1] & 1]	<p>This LogicsManager is used to activate generally the voltage biasing to the sub controller. If the LogicsManager is false the output will be on the initial state (see parameter 5608 <a href="#">p. 323</a>).</p> <p>The LogicsManager condition status 'TRUE' is activating the voltage or reactive power regulation according to the LogicsManager 'V/Q control' ID 12941 <a href="#">p. 333</a>).</p>
				<p><b>Notes</b></p> <p>For information on the LogicsManager and its default settings see <a href="#">Chapter 9.4.1 "LogicsManager Overview" on page 689</a>.</p>

#### 4.5.12.6 Power Factor Control

The easYgen cover a wide range of power factor control tasks:

- Controller type can be selected for an analog PID or a three-step controller (see chapter [Chapter 4.5.12.6.2 "Configure Power Factor Control" on page 329](#))
- PF(P) characteristic is available (see chapter [Chapter 4.5.12.6.3 "Power Factor Characteristic" on page 333](#))
- Beside PF(P) characteristic, Q(V) characteristic is available too (see chapter [Chapter 4.5.12.6.3 "Power Factor Characteristic" on page 333](#)).
- Reactive power control at the interchange point offers another opportunity of power factor control (see chapter [Chapter 4.5.12.6.1 "Control The Power Factor / Reactive Power At The Mains Interchange Point" on page 328](#)).

4.5.12.6.1 Control The Power Factor / Reactive Power At The Mains Interchange Point

General notes

Being parallel to the utility, it is desired in some application to control either the power factor or the amount of imported/exported inductive reactive power in kvar at the mains interchange point. Similar to an import/export active power setpoint, all easYgens can be programmed to the same setpoint and will share between each other the reactive power to reach this setpoint.

The easYgen can work as reactive power control at the interchange point. In this mode the gensets are monitored and restricted in reactive power flow (outcome and income; respectively leading and lagging).

Generator Reactive Power Limitations

A reactive power control (kvar or power factor) can cause an overload or damage of the generator. To avoid this the easYgen provides a 2-step protection:

1. ► The own absolute generator current is monitored with a percentage setting related to rated current input (ID 1754 ↪ p. 95). The easYgen limits or controls down the excitation that this given level (ID 5791 ↪ p. 330) is not exceeded.
2. ► The inductive reactive power **outcome** of the own generator is limited according to the configuration of ID 5792 ↪ p. 330.

Or:

The inductive reactive power **income** of the own generator is limited according to the configuration of ID 5793 ↪ p. 330.

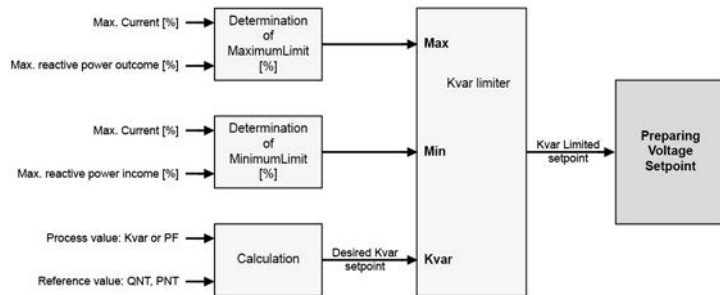

Fig. 105: The kvar setpoint is limited to protect the generator

Tracking of the limitation

An active Limitation is

- indicated as 'Gen excitation lim.' on the display (HMI)
- driving the LogicsManager command variable 05.18 Gen excitation lim. from FALSE to TRUE
- driving an event logger entry



4.5.12.6.2 Configure Power Factor Control

ID	Parameter	CL	Setting range [Default]	Description
5625	Power factor Control	2	[PID analog]	The power factor is controlled using an analog PID controller.
			3pos controller	The power factor is controlled using a three-step controller.
			Off	Power factor control is not carried out.
5613	Proportional gain	2	0.01 to 100.00 [1.00]	<p>The proportional coefficient specifies the gain. By increasing the gain, the response is increased to permit larger corrections to the variable to be controlled.</p> <p>The farther out of tolerance the process is the larger the response action is to return the process to the tolerance band.</p>
				<p><b>Notes</b></p> <p>If the gain is configured too high, the result is excessive overshoot/undershoot of the desired value.</p> <p>This parameter is only visible if power factor control (parameter 5625 ↗ p. 329) is configured to "PID analog".</p>
5614	Integral gain	2	0.01 to 100.00 [1.00]	<p>The integral gain identifies the I part of the PID controller. The integral gain corrects for any offset (between setpoint and process variable) automatically over time by shifting the proportioning band.</p> <p>Reset automatically changes the output requirements until the process variable and the setpoint are the same. This parameter permits the user to adjust how quickly the reset attempts to correct for any offset. The integral gain constant must be greater than the derivative time constant.</p> <p>If the integral gain constant is too large, the engine will continually oscillate. If the integral gain constant is too small, the engine will take too long to settle at a steady state.</p>
				<p><b>Notes</b></p> <p>This parameter is only visible if power factor control (parameter 5625 ↗ p. 329) is configured to "PID analog".</p>
5615	Derivative ratio	2	0.01 to 100.00 [0.01]	<p>The derivative ratio identifies the D part of the PID controller. By increasing this parameter, the stability of the system is increased.</p> <p>The controller will attempt to slow down the action of the actuator in an attempt to prevent excessive overshoot or undershoot.</p> <p>Essentially this is the brake for the process. This portion of the PID loop operates anywhere within the range of the process unlike reset.</p>
				<p><b>Notes</b></p> <p>This parameter is only visible if power factor control (parameter 5625 ↗ p. 329) is configured to "PID analog".</p> <p>The default configured controller acts like a PI controller what is the valid D part setting for systems with secondary controllers.</p>
5660	Deadband	1	0.001 to 0.300 [0.010]	<p>The generator power factor is controlled in such a manner, when paralleled with the mains, so that the monitored power factor does not deviate from the configured power factor setpoint by more than the value configured in this parameter without the controller issuing a raise/lower signal to the voltage regulator.</p> <p>This prevents unneeded wear on the raise/lower relay contacts.</p>

## Configuration

Configure Application > Configure Controller > Power Factor Control

ID	Parameter	CL	Setting range [Default]	Description
				<p><b>Notes</b></p> <p>This parameter is only visible if power factor control (parameter 5625 ↗ p. 329) is configured to "3pos controller".</p>
5661	<b>Time pulse minimum</b>	1	0.01 to 2.00 s <b>[0.05 s]</b>	<p>A minimum pulse on time must be configured here.</p> <p>The shortest possible pulse time should be configured to limit overshoot of the desired power factor reference point.</p>
				<p><b>Notes</b></p> <p>This parameter is only visible if power factor control (parameter 5625 ↗ p. 329) is configured to "3pos controller".</p>
5662	<b>Gain factor</b>	1	0.1 to 10.0 <b>[5.0]</b>	<p>The gain factor <math>K_p</math> influences the operating time of the relays.</p> <p>By increasing the number configured in this parameter, the operating time of the relay will be in-creased in response to a deviation from the power factor reference.</p> <p>By increasing the gain, the response is increased to permit larger corrections to the variable to be controlled.</p> <p>The farther out of tolerance the process is the larger the response action is to return the process to the tolerance band. If the gain is configured too high, the result is excessive overshoot/undershoot of the desired value.</p>
				<p><b>Notes</b></p> <p>This parameter is only visible if power factor control (parameter 5625 ↗ p. 329) is configured to "3pos controller".</p>
5663	<b>Expand dead-band factor</b>	1	1.0 to 9.9 <b>[1.0]</b>	<p>If the measured generator power factor is within the deadband range (parameter 5660 ↗ p. 329) and the configured delay expand deadband time (parameter 5664 ↗ p. 330) expires, the deadband will be multiplied with the factor configured here.</p>
				<p><b>Notes</b></p> <p>This parameter is only visible if power factor control (parameter 5625 ↗ p. 329) is configured to "3pos controller".</p>
5664	<b>Delay expand deadband</b>	1	1.0 to 9.9 s <b>[2.0 s]</b>	<p>The measured generator power factor must be within the deadband range for the time configured here in order to multiply the deadband with the factor configured in parameter 5663 ↗ p. 330.</p>
				<p><b>Notes</b></p> <p>This parameter is only visible if power factor control (parameter 5625 ↗ p. 329) is configured to "3pos controller".</p>
5791	<b>Max. generator current</b>	2	0 to 150% <b>[100%]</b>	<p>This is the maximum generator current during reactive power control. The percentage is related to the rated current setting (ID 1785 ↗ p. 96).</p>
5792	<b>Max. react.inductive pwr.gen</b>	2	0 to 150% <b>[80%]</b>	<p>This is the maximum accepted generator reactive inductive load (outcome) during reactive power control at the interchange point. The percentage is related to the reactive power setting (ID 1746 ↗ p. 96).</p>
5793	<b>Max. react.capacity pwr.gen</b>	2	0 to 150% <b>[50%]</b>	<p>This is the maximum accepted generator reactive capacitive load (income) during reactive power control at the interchange point. The percentage is related to the reactive power setting (ID 1746 ↗ p. 96).</p>

ID	Parameter	CL	Setting range [Default]	Description
5638	<b>Power Factor setpoint 1 source</b>	2	Determined by AnalogManager	The power factor setpoint 1 source can be selected from the available data sources.  Though it is possible to select from all available data sources ( <a href="#">↪ Chapter 9.3.1 "Data Sources" on page 671</a> ), only the following data sources may be used:
			<b>[05.10]</b>	Internal power factor setpoint 1  Internal power factor control setpoint 1 (parameter 5620 <a href="#">↪ p. 332</a> ) is used as setpoint 1
			05.11	Internal power factor setpoint 2  Internal power factor control setpoint 2 (parameter 5621 <a href="#">↪ p. 332</a> ) is used as setpoint 1
			05.12	Interface power factor setpoint  The setpoint, which is transmitted via the interface, is used as setpoint
			05.16	Discrete raise/lower power factor  The setpoint from the discrete raise/lower power factor function is used as setpoint
			06.01	Analog input 1  Analog input 1 is used to control the setpoint
			06.02	Analog input 2  Analog input 2 is used to control the setpoint
			06.03	Analog input 3  Analog input 3 is used to control the setpoint
			06.04	Analog input 4  Analog input 4 is used to control the setpoint
				<b>Notes</b>  The power factor setpoint may be adjusted between 0.71 leading and 0.71 lagging.  Selecting a different data source may cause the controller to not operate properly.
5639	<b>Power Factor setpoint 2 source</b>	2	Determined by AnalogManager	The power factor setpoint 2 source can be selected from the available data sources.  Though it is possible to select from all available data sources ( <a href="#">↪ Chapter 9.3.1 "Data Sources" on page 671</a> ), only the following data sources may be used:
			05.10	Internal power factor setpoint 1  Internal power factor control setpoint 1 (parameter 5620 <a href="#">↪ p. 332</a> ) is used as setpoint 2
			<b>[05.11]</b>	Internal power factor setpoint 2  Internal power factor control setpoint 2 (parameter 5621 <a href="#">↪ p. 332</a> ) is used as setpoint 2
			05.12	Interface power factor setpoint  The setpoint, which is transmitted via the interface, is used as setpoint

## Configuration

ID	Parameter	CL	Setting range [Default]	Description
			05.16	Discrete raise/lower power factor The setpoint from the discrete raise/lower power factor function is used as setpoint
			06.01	Analog input 1 Analog input 1 is used to control the setpoint
			06.02	Analog input 2 Analog input 2 is used to control the setpoint
			06.03	Analog input 3 Analog input 3 is used to control the setpoint
			06.04	Analog input 4 Analog input 4 is used to control the setpoint
				<b>Notes</b> The power factor setpoint may be adjusted between 0.71 leading and 0.71 lagging. Selecting a different data source may cause the controller to not operate properly.
5743	PF/kvar set-point 1 mode		Mns. Export kvar Mns. Import kvar Mains PF [Gen. PF]	Selection of the mode for PF/kvar setpoint 1.
5620	Int. power factor setpoint 1	0	-0.999 to +1.000 [+1.000]	The desired power factor may be configured here so that the reactive power is regulated in the system. The designations "+" and "-" stand for inductive/lagging (generator overexcited) and capacitive/leading (generator underexcited) reactive power. This setpoint is active only in mains parallel operation.
5744	PF/kvar set-point 2 mode		Mns. Export kvar Mns. Import kvar Mains PF [Gen. PF]	Selection of the mode for PF/kvar setpoint 2.
5745	Int. kvar set-point 1		0.0 to +99999.9 [0.0]	This setpoint is active only if PF/kvar setpoint 1 is set to Mns. Export kvar or Mns. Import kvar.
5621	Int. power factor setpoint 2	0	-0.999 to +1.000 [+1.000]	The desired power factor may be configured here so that the reactive power is regulated in the system. The designations "-" and "+" stand for inductive/lagging (generator overexcited) and capacitive/leading (generator underexcited) reactive power. This setpoint is active only in mains parallel operation.
5746	Int. kvar set-point 2		0.0 to +99999.9 [0.0]	This setpoint is active only if PF/kvar setpoint 2 is set to Mns. Export kvar or Mns. Import kvar.

ID	Parameter	CL	Setting range [Default]	Description
12921	<b>Setp. 2 pwr.factor</b>	2	Determined by LogicsManager [[0 & 1] & 1]	If this LogicsManager condition is TRUE, the power factor setpoint 2 will be enabled, i.e. the setting of parameter 5639 <a href="#">↗</a> p. 331 overrides the setting of parameter 5638 <a href="#">↗</a> p. 331.  <b>Notes</b> For information on the LogicsManager and its default settings see <a href="#">↗ Chapter 9.4.1 "LogicsManager Overview" on page 689.</a>
5622	<b>React. pwr. ctrl setpoint ramp</b>	2	0.01 to 100.00 %/s [3.00 %/s]	The different setpoint values are supplied to the controller via this ramp.  The slope of the ramp is used to alter the rate at which the controller modifies the setpoint value. The faster the change in the setpoint is to be carried out, the greater the value entered here must be.  <b>Notes</b> This ramp is also used in isolated operation for loading or unloading an additional genset. An excessive oscillation may occur if the ramp is configured too high.
12941	<b>V/Q control</b>	2	Determined by LogicsManager [[04.07 & 04.06] & 1]	With LogicsManager can be controlled if a voltage control or a reactive power control should be performed. If this LogicsManager condition is TRUE, the reactive power control is performed.

#### 4.5.12.6.3 Power Factor Characteristic

##### General notes

The Power Factor Characteristic function is adapting the reactive power flow between generator and mains to support a dynamic stabilization of the mains. Some network provider prefer therefore a power factor control over real power PF(P) (see chapter [↗ Chapter 4.5.12.6.3.1 "Power factor characteristic PF\(P\)" on page 333](#) for more details).

Other provider prefer power factor control over mains voltage Q(V) as described in chapter [↗ Chapter 4.5.12.6.3.2 "Power factor characteristic Q\(V\)" on page 335](#). Both methods are configurable alternatively.



##### **Enhanced according BDEW Requirements**

*Both power factor characteristic curves now offer four point settings.*

*Factory settings come with backward compatibility.*

##### Power factor characteristic PF(P)

A method to support the mains is to feed different reactive power values into the grid in relation to the own active power value. The reactive power is defined through a power factor setpoint for the generator. This can be defined in characteristic curve.

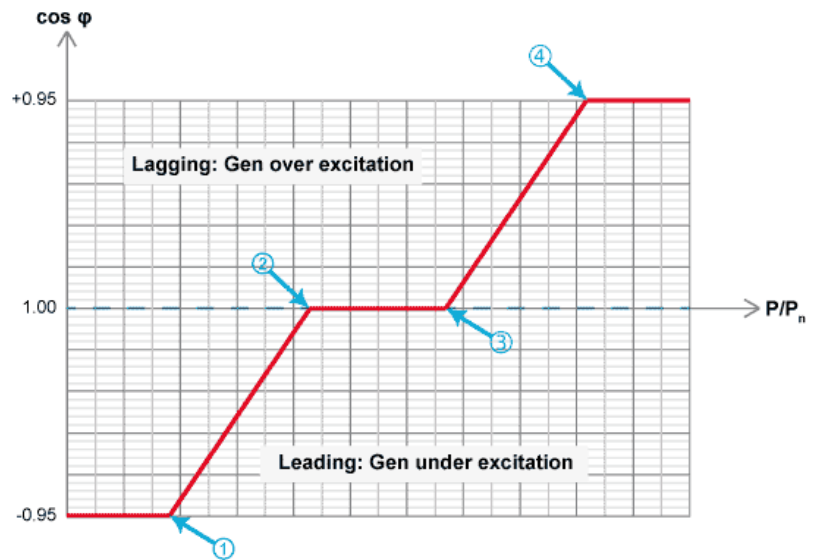

Fig. 106: Power factor characteristic (schematic)

The characteristic is defined by four points (① .. ④). The power factor corresponding to this characteristic is available as data source 05.29 in the Analog Manager.



To use this function, the source (05.29) must be applied as source to one of the setpoints e.g., "Power factor setpoint 1" (parameter 5638 ↪ p. 331).

ID	Parameter	CL	Setting range [Default]	Description
5786	Power factor characteristic	2	[PF(P)]	A power factor setpoint is determined according to the characteristic curve: Power factor in relation to the actual Generator power.
			Q(V)	A power factor setpoint is calculated according to the characteristic curve: Generator reactive power in relation to the mains voltage.
5787	Point 1 power	2	0.0 to 99999.9 kW [0.0 kW]	The value entered into "Point 1 power" defines the cos phi (P) characteristic.
5788	Point 1 cos phi	2	-0.999 to 1.000 [-0.950]	The desired "Point 1 cos phi" may be configured here which defines the cos phi (P) characteristic.  The designations "+" and "-" stand for inductive/lagging (generator overexcited) and capacitive/leading (generator underexcited) reactive power.
5789	Point 2 power	2	0.0 to 99999.9 kW [200.0 kW]	The value entered into "Point 2 power" defines the cos phi (P) characteristic.
5790	Point 2 cos phi	2	-0.999 to 1.000 [0.950]	The desired "Point 2 cos phi" may be configured here which defines the cos phi (P) characteristic.  The designations "+" and "-" stand for inductive/lagging (generator overexcited) and capacitive/leading (generator underexcited) reactive power.
5028	Point 3 power	2	0.0 to 99999.9 kW [200.0 kW]	The value entered into "Point 3 power" defines the cos phi (P) characteristic.

ID	Parameter	CL	Setting range [Default]	Description
5029	Point 3 cos phi	2	-0.999 to 1.000 [0.950]	The desired "Point 3 cos phi" may be configured here which defines the cos phi (P) characteristic.  The designations "+" and "-" stand for inductive/lagging (generator overexcited) and capacitive/leading (generator underexcited) reactive power.
5030	Point 4 power	2	0.0 to 99999.9 kW [200.0 kW]	The value entered into "Point 4 power" defines the cos phi (P) characteristic.
5031	Point 4 cos phi	2	-0.999 to 1.000 [0.950]	The desired "Point 4 cos phi" may be configured here which defines the cos phi (P) characteristic.  The designations "+" and "-" stand for inductive/lagging (generator overexcited) and capacitive/leading (generator underexcited) reactive power.

**Power factor characteristic Q(V)**

Another method to support the mains is to feed different reactive power values into the grid in relation to the mains voltage [parameter 5786 ↗ p. 334 = Q(V)]. The reactive power is defined through the value Q/S rated over voltage. This can be defined in a characteristic curve. The resulting outcome for the reactive power control is then a power factor setpoint.

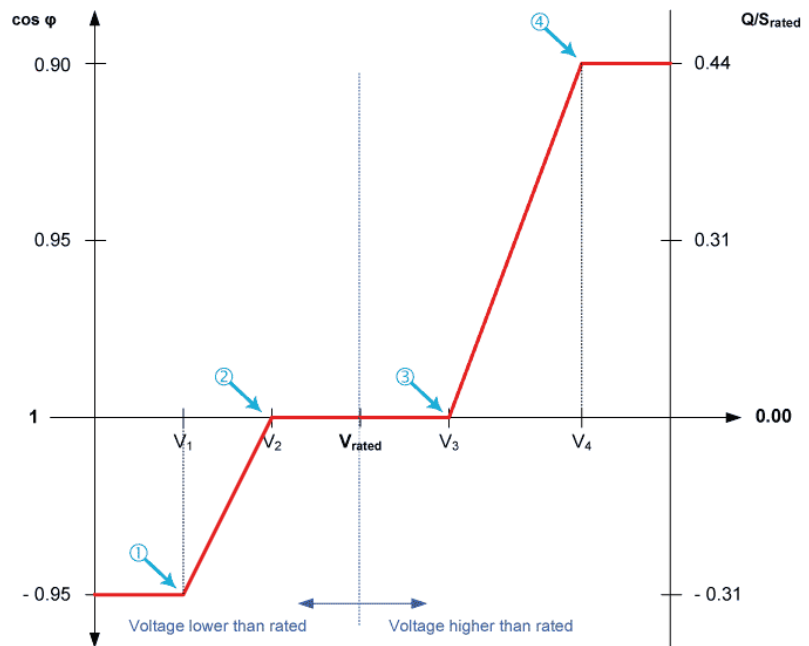

Fig. 107: Power factor characteristic according to the relation Q/S rated over rated voltage

The characteristic is defined by four points (① .. ④). The power factor corresponding to this characteristic is available as data source 05.29 in the Analog Manager.



To use this function, the source (05.29) must be applied as source to one of the setpoints e.g., "Power factor setpoint 1" (parameter 5638 ↗ p. 331).

ID	Parameter	CL	Setting range [Default]	Description
5778	Point 1 voltage		45.0 to 150.0 % [98.0 %]	The value entered into "Point 1 Voltage" defines the x-coordinate of point 1
5779	Point 1 Q/S rated		-0.99 to +0.99 [-0.31]	The value entered into "Point 1 Reactive power" defines the y-coordinate of point 1
5797	Point 2 voltage		45.0 to 150.0 % [106.0 %]	The value entered into "Point 2 Voltage" defines the x-coordinate of point 2
5798	Point 2 Q/S rated		-0.99 to +0.99 [+0.31]	The value entered into "Point 2 Reactive power" defines the y-coordinate of point 2
5032	Point 3 voltage		0.0 to 150.0 % [106.0 %]	The value entered into "Point 3 Voltage" defines the x-coordinate of point 3
5033	Point 3 Q/S rated		-0.99 to +0.99 [+0.31]	The value entered into "Point 3 Reactive power" defines the y-coordinate of point 3
5034	Point 4 voltage		0.0 to 150.0 % [106.0 %]	The value entered into "Point 4 Voltage" defines the x-coordinate of point 4
5035	Point 4 Q/S rated		-0.99 to +0.99 [+0.31]	The value entered into "Point 4 Reactive power" defines the y-coordinate of point 4
5799	Q(V) response time		001 to 999 s [10 s]	<p>The response with a new reactive power setpoint acting on the analog command variable 05.29 PF characteristic can be delayed. Q(V) response time is used to calculate the power factor characteristic Q(V), parameter 5786 ↪ p. 334.</p> <p><b>Notes</b></p> <p>The delay is realized with a PT-1 filter. Therefore the reaction times are optimized for the range 10 s until 60 s within a symmetrical characteristic curve.</p> <p>Accuracy of the setup Q(V) response time is given within a symmetrical characteristic curve.</p>
5023	Q(V) Hysteresis		0 to 20% [0%]	The hysteresis for the Q(V) characteristic acts as a deadband for the selected band. If the Mains voltage is within the hysteresis the resulting power factor characteristic reference doesn't change.

#### 4.5.12.7 Load Share Control

The easYgen performs proportional load and/or var sharing. This means each generator will share the load at the same percentage level of the generator rated power when paralleled against the mains, in an isolated operation with multiple generators paralleled, or when re-synchronizing the common bus to the mains.

Also in isolated operation the load ramp rate parameters 5522 ↪ p. 312 and 5622 ↪ p. 333 are used to ramp a new generator onto the other.





*If not enough nominal power on the busbar is available, from now on the ramping of an engine onto others will be interrupted but the load sharing will be executed immediately. This is to avoid overloading of already online generators.*

*Proportional load/var sharing will not be performed when the easYgen has the GCB closed and is in the constant power/base load mode.*

A system can consist out of 32 gensets which are controlled by a single easYgen.

#### 4.5.12.7.1 Mains Parallel Operation With Mains Interchange Real Power Control (Import/Export)

The easYgen controllers maintain the real load level on the individually controlled generators at a level so that the real power setpoint at the mains interchange remains at the configured setpoint. The real power setpoint for the mains interchange must be configured identically for each easYgen.

The easYgen controller communicates with other controls in the system via a CAN bus. This enables the controllers to adjust the real power generated by the generator while remaining within the rated power of the generator. A smaller generator will contribute less real power as compared to a large generator, but they will both be utilized to the same capacity factor. An example of this would be a 100 kW generator with a configured 1000 kW generator and a mains interchange of 825 kW. The 100 kW generator would contribute 75 kW and the 1000 kW generator would contribute 750 kW or both generators would be at 75 % of their rated capacity.

How the reactive power handling is executed depends the PF/kvar setpoint mode. Two setpoints (5743 ↪ p. 332 and 5744 ↪ p. 332) are available. Each setpoint allows the modes:

- Gen PF
- Mains PF
- Mains Import kvar
- Mains export kvar

**In PF modes** the reactive load sharing is not performed when operating in parallel with the mains. Reactive power control will be defined by the configured power factor setpoints (5620 ↪ p. 332 or 5621 ↪ p. 332) of the individual controllers. If the power factor controller setpoint is configured as +0.950, the easYgen will proportionally share the real load with all generators in parallel with the mains while controlling the reactive power at a 0.95 inductive (lagging) power factor regardless of the what power factor the mains is operating at.

The parameter "Active power Load share factor" (parameter 5530 ↪ p. 342) can be used now to define the priority of the real power sharing reference variable (real power at interchange). A higher configured percentage influences the control more towards maintaining the real power setpoint for the interchange. A lower configured percentage influences the control more towards maintaining real power sharing between units.



*The parameter "React. power Load share factor" (parameter 5630 ↪ p. 342) has no influence here.*

**In kvar modes** the reactive load sharing is performed when operating in parallel with the mains. Mains import/export kvar control at the interchange point will be determined by the configured int. kvar setpoints (5745 ↪ p. 332 or 5746 ↪ p. 332) of the individual controllers.

### 4.5.12.7.2 Isolated Operation In Parallel

The easYgen controllers maintain the voltage and frequency of the individually controlled generators at a constant level. This makes it imperative that the voltage and frequency setpoints are configured identically for each easYgen.

The easYgen controller communicates with other controls in the system via a CAN bus. This enables the controllers to adjust the real power generated by the generator while remaining within the rated power of the generator. A smaller generator will contribute less real power as compared to a large generator, but they will both be utilized to the same capacity factor.

#### Example

An example of this would be a 100 kW generator and a 1000 kW generator with an 825 kW load. The 100 kW generator would contribute 75 kW and the 1000 kW generator would contribute 750 kW or both generators would be at 75 % of their rated capacity.

The reactive power will be shared proportionally among all generators involved.

The parameter "Active power Load share factor" (parameter 5530 ↪ p. 342) can be used to define the priority of the reference variable for real power sharing. A higher configured percentage influences the control more towards frequency control. A lower configured percentage influences the control more towards real power sharing.

The parameter "React. power Load share factor" (parameter 5630 ↪ p. 342) can be used now to define the priority of the reference variable for reactive power sharing. A higher configured percentage influences the control more towards voltage control. A lower configured percentage influences the control more towards reactive power sharing.

### 4.5.12.7.3 Re-synchronization Of The Busbar To The Mains

The system is operating as an isolated system, for synchronization to be performed the voltage and frequency differentials of the mains and bus must be within the configured windows.

The bus frequency reference point is dictated by the measured mains frequency and the configured frequency differential (+ slip frequency setpoint offset (parameter 5502 ↪ p. 307)).

**Example**

If + slip frequency setpoint offset = 0.2 Hz, the easYgen will calculate the bus frequency reference point as:

- [measured mains frequency] + [slip frequency setpoint offset] = bus frequency reference point

A practical example of this would be:

- The monitored mains frequency is 60 Hz
- Configured + slip frequency setpoint offset = 0.2 Hz
- [60 Hz] + [0.2 Hz] = 60.2 Hz bus frequency reference point

The differential voltage is configured as a window. The monitored voltage from the potential transformers secondary for the mains and the bus must be within the configured voltage differential limit in relation to the rated voltage configuration.

This means that the voltage window dV [%] is in relation to the rated voltage configuration [%].

When the monitored bus frequency and voltage are within the configured differential limits, the "Command: close MCB" relay will enable, closing the MCB, and the system will be paralleled to the mains.

**4.5.12.7.4 Prerequisites**

All easYgen controllers connected to the system must have rated system frequencies and breaker logic configured identically and the parameter "Active power load share" (parameter 5531 ↗ p. 342) or "Reactive power load share" (parameter 5631 ↗ p. 342) must be enabled.

**4.5.12.7.5 Load-Share Interface**

The easYgen utilizes a peer relationship between units to control the system. This permits for parallel applications of up to 32 generators.



Refer to ↗ Chapter 3.4 "CAN Bus Interfaces" on page 80 for information about the CAN bus connection.

**4.5.12.7.6 Load/Var Sharing Via The CAN Bus**

The parameter "Active load sharing factor" determines if and how a generator performs real power or frequency control when paralleled with other generators in an isolated operation. This parameter is defined as a percentage.

In the figure below ( Fig. 108) 10 % means increased real power control and 99 % increased frequency control. This parameter should be configured with the same value for each generator.

In the illustrated control system, it must be noted that each control calculates the mean utilization factor of all controls from the data transmitted via the CAN bus and then compares this with its own utilization factor. The utilization factor is compared with the reference variable and results in a new reference variable setpoint. Frequency and real power control are carried out simultaneously in these controls (corresponding to the reference variable).

Frequency control is carried out via the measured voltage/frequency of the voltage system. The MPU is used merely for monitoring functions, or is available as a control value to the secondary controller.

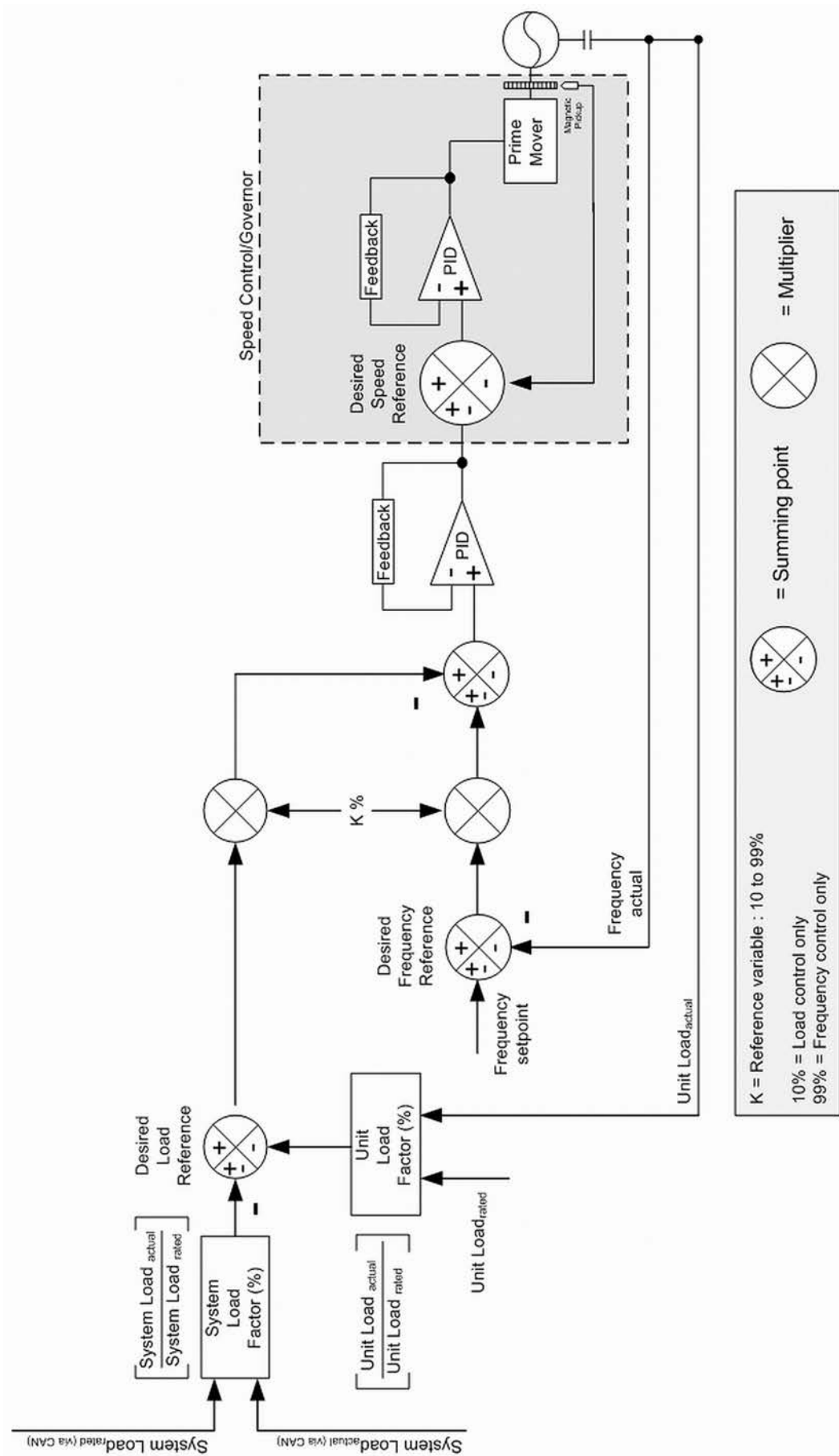

Fig. 108: CAN bus load/var sharing, diagram

4.5.12.7.7 Parameters

ID	Parameter	CL	Setting range [Default]	Description
5531	Active power load share	2	[On]	Active power load share is enabled. When multiple generators are operating in parallel, the real power is shared proportionally.
			Off	Active power load share is disabled
5530	Active power load share	2	10 to 99 % [50 %]	<p>It is possible to change the emphasis placed on maintaining control variables. By increasing or decreasing the percentage value in this parameter, the control places a higher priority on maintaining the primary or secondary control reference variable.</p> <p>If the value for this parameter is configured higher, maintaining the primary control variable has a higher priority. If the value for this parameter is configured lower, maintaining the secondary control variable has a higher priority.</p> <p><b>Primary control variable</b></p> <ul style="list-style-type: none"> <li>■ Isolated operation = frequency maintained</li> <li>■ Mains parallel operation = real power level at the mains interchange point maintained</li> </ul> <p><b>Secondary control variable</b></p> <ul style="list-style-type: none"> <li>■ Isolated operation = real power sharing with other generators maintained</li> <li>■ Mains parallel operation = real power sharing with other generators maintained</li> </ul>
				<p><b>Notes</b></p> <p>The smaller this factor the higher the priority to equally share the load among all generators. If 99 % is configured here, only the primary control reference variable is considered. If 10 % is configured here, only the secondary control reference variable is considered.</p>
5631	Reactive power load share	2	[On]	Reactive power load share is enabled. When multiple generators are operating in parallel, the reactive power is shared proportionally.
			Off	Reactive power load share is disabled
5630	React. power load share factor	2	10 to 99 % [50 %]	<p>It is possible to change the emphasis placed on maintaining control variables. By increasing or decreasing the percentage value in this parameter, the control places a higher priority on maintaining the primary or secondary control reference variable.</p> <p>If the value for this parameter is configured higher, maintaining the primary control variable has a higher priority. If the value for this parameter is configured lower, maintaining the secondary control variable has a higher priority.</p> <p><b>Primary control variable</b></p> <ul style="list-style-type: none"> <li>■ Isolated operation = voltage maintained</li> </ul> <p><b>Secondary control variable</b></p> <ul style="list-style-type: none"> <li>■ Isolated operation = reactive power sharing with other generators maintained</li> </ul>
				<p><b>Notes</b></p> <p>The smaller this factor the higher the priority to equally share the load among all generators.</p> <p>If 99 % is configured here, only the primary control reference variable is considered. If 10 % is configured here, only the secondary control reference variable is considered.</p>

### 4.5.12.7.8 Load Sharing And Segments

#### Load Share Control Grouping

Load sharing with several gensets is possible for a supply of several split busbars. Each of this individual groups is called a segment.

**Up to four segments can be managed easily for load share by LogicsManager!**

#### General

a group breaker splits the busbar in a way that some gensets supply one busbar and some supply another one. However, it is necessary to group the gensets, which supply the same busbar.

The designer of a busbar system gives all individual bus bars an own number: The Segment Number for the easYgen is defined with ID 1723. Each easYgen is connected with its GCB on one of these segments.

The configured segment number can be changed to one of three alternative segment numbers by three LogicsManager equations. These LogicsManager equations stand for the segment numbers 2, 3, or 4. They are usually controlled by circuit breaker reply auxiliary contacts. This is finally the segment number the easYgens interacts with.

#### Example

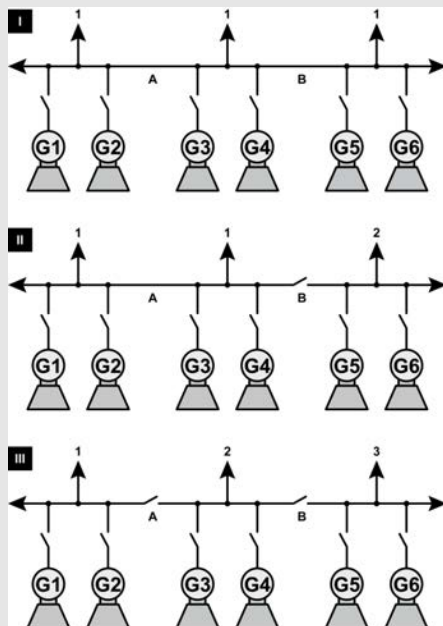

Fig. 109: Load sharing - grouping

Six gensets (G1 through G6) supply a system with two group breakers (A, B) as shown in . All gensets have the same segment number configured #1 (parameter 1723 ↪ p. 344)

Case I - Group breakers A and B are closed and G1 through G6 supply the same busbar. The same segment number is configured to each genset since all gensets supply the same busbar.

Case II - Group breaker A is closed and group breaker B is open (G1 through G4 supply a different busbar than G5 and G6). A different segment number must be selected for G5 and G6 by enabling the LogicsManager function "Segment no.2 act" (parameter 12929 ↪ p. 344) in order to change the segment number of G5 and G6 to #2.

Case III - Group breakers A and B are open (G1 and G2, G3 and G4, as well as G5 and G6 supply different busbars).

A different segment number must be selected for G3 and G4 (LogicsManager function "Segment no.2 act" (parameter 12929 ↪ p. 344)) as well as to G5 and G6 (LogicsManager function "Segment no.3 act" (parameter 12928 ↪ p. 344)).

With this, the segment number of G3 and G4 is changed to #2 and the segment number of G5 and G6 is changed to #3.

## Configuration

Configure Application > Configure Controller > Load Share Control

ID	Parameter	CL	Setting range [Default]	Description
1723	<b>Segment number</b>	2	1 to 32 [1]	The genset is assigned a load share segment number with this parameter. This segment number may be overridden by the following parameters 12929 ↗ p. 344, 12928 ↗ p. 344, and 12927 ↗ p. 344.
12929	<b>Segment no.2 act</b>	2	Determined by LogicsManager 00.87 [(0 & 1) & 1]	Once the conditions of the LogicsManager have been fulfilled, this genset is assigned load share segment number 2 (this parameter has priority over parameters 12928 ↗ p. 344 and 12927 ↗ p. 344). <b>Notes</b> For information on the LogicsManager and its default settings see ↗ <i>Chapter 9.4.1 "LogicsManager Overview" on page 689.</i>
12928	<b>Segment no.3 act</b>	2	Determined by LogicsManager 00.88 [(0 & 1) & 1]	Once the conditions of the LogicsManager have been fulfilled, this genset is assigned load share segment number 3 (this parameter has priority over parameters 12927 ↗ p. 344). <b>Notes</b> For information on the LogicsManager and its default settings see ↗ <i>Chapter 9.4.1 "LogicsManager Overview" on page 689.</i>
12927	<b>Segment no. 4 act</b>	2	Determined by LogicsManager 00.89 [(0 & 1) & 1]	Once the conditions of the LogicsManager have been fulfilled, this genset is assigned load share segment number 4. <b>Notes</b> For information on the LogicsManager and its default settings see ↗ <i>Chapter 9.4.1 "LogicsManager Overview" on page 689.</i>
5568	<b>Mode ext. load share gateway</b>	2	[0] 1 2 3 4 5 6 7	The operation mode for the external Woodward Load Share Gateway (LSG) is configured here. Off <i>Woodward EGCP-2</i> RS-485 (P & Q) <i>Woodward SPM-D</i> <b>R</b> = 4.99k   <b>P</b> : 0 – 4 V (0 to 100 %)   <b>Q</b> : 0 – 5 V (-85% to +85 %) <i>Woodward MFR 15</i> <b>R</b> = 4.99k   <b>P</b> : 0 – 4 V (0 to 100 %) <i>Woodward 2301 A</i> <b>R</b> = 54.90k   <b>P</b> : 0 – 3 V (0 to 100 %) <i>Caterpillar LSM</i> <b>R</b> = 25.00k   <b>P</b> : 0 – 3 V (0 to 100%) <i>Cummins PCC 3100, 3200, 3201, 3300</i> <b>R</b> = 5.00k   <b>P</b> : 0 – 2.5 V (-14.1 to 121.9 %)   <b>Q</b> : 0 – 2.5 V (-16.7 % to +125.3 %) <i>POW-R-CON</i> <b>R</b> = 20.67k   <b>P</b> : 0 – 5 V (0 to 100 %) Prepared <b>R</b> = 25.00k   <b>P</b> : -5 – +5 V (0 to 100 %)



ID	Parameter	CL	Setting range [Default]	Description
			8	Prepared <b>R</b> = 25.00k   <b>P</b> : 0 – 7 V (0 to 100 %)
			9	Woodward GCP/MFR CAN ( <b>P</b> & <b>Q</b> )1 – easYgens and GCP/MFR share the same CAN bus
			10 to 16	Not defined
				<b>Notes</b> Refer to the Load Share Gateway (LSG) Manual 37442 for security guidelines and detailed information about the configuration.  <b>R</b> : Internal resistance <b>P</b> : Range for active power <b>Q</b> : range for reactive power

#### 4.5.12.7.9 Droop

The isochronous running frequency or voltage controllers keep the desired frequency or voltage set point independent on the real or reactive power of the generator.

The **frequency controller** with activated droop behavior (Logics-Manager ID12904 ↗ p. 307) reduces the desired frequency set-point dependent on the active power of the generator (ID1752 ↗ p. 95). In case of a full loaded engine the frequency set-point will be reduced with the percentage value (ID5504 ↗ p. 307) related to rated frequency.

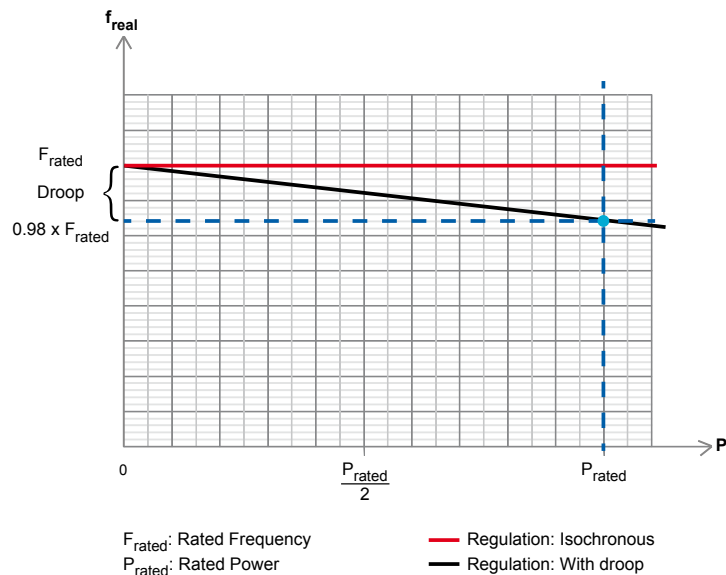

Fig. 110: Frequency controller - behavior with and without droop, diagram

The resulting frequency setpoint is calculated as follows:  $F'_{Set} = F_{Set} - (P_{real} * (F_{rated} * \text{droop factor}) / P_{rated})$

The **voltage controller** with activated droop behavior (Logics-Manager ID12905 ↗ p. 327) reduces the desired voltage setpoint dependent on the reactive power of the generator (ID1758 ↗ p. 95). In case of a full reactive loaded generator the voltage will be reduced with the percentage value (ID5604 ↗ p. 327) of the rated frequency.

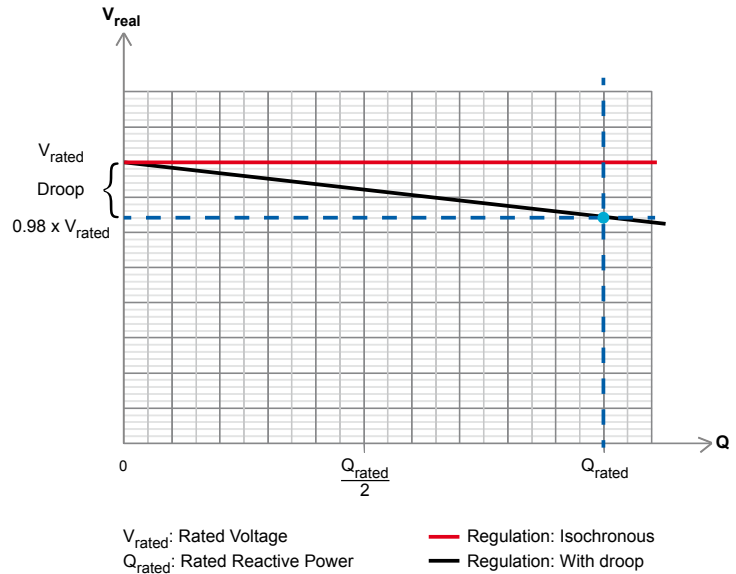

Fig. 111: Voltage controller - behavior with and without droop, diagram

The resulting voltage setpoint is calculated as follows:  $V_{Set} = V_{Set} - (Q_{real} * (V_{rated} * droop\ factor) / Q_{rated})$

**Function Droop Tracking**

The droop tracking for frequency/voltage control is implemented such that when the control is switched to frequency/voltage control with droop the frequency/voltage real value does not change at the current active/reactive load. This is provided by pre-calculating a setpoint offset, which is needed to hold rated frequency/voltage at present load.

This is a feature in applications where for example the load sharing over communication interface gets lost and the number of generators remains the same.

**Droop Tracking On/Off**

The easYgen allows disabling the droop tracking for frequency and voltage generally. This makes sense in applications where the number of generators can vary during running in droop mode.

**Load sharing in Droop mode On/Off**

Multiple easYgens are load sharing under each other, if they run isolated from mains or they control export/import power at a common interchange point. For dynamic reasons it makes sense to disable the load sharing, when the easYgens running in droop or can fall into droop mode (Missing member case).

ID	Parameter	CL	Setting Range [Default]	Description
5747	Droop tracking	2	[On]	The frequency and voltage setpoint offset is pre-calculated to hold the frequency and voltage, when control is switched into droop.
			Off	The setpoint offset is always zero. <b>Notes</b> In the previous versions this function internally was fixed to "ON"!
5748	Load sharing in droop mode		[On]	As long the load sharing function is enabled, it is done in droop mode too.
			Off	The load sharing is generally disabled in droop mode. <b>Notes</b> In the previous versions this function internally was fixed to "ON"!

Table 53: Droop related parameters

**4.5.12.8 PID {x} Control**

**General notes**



*The following parameters only apply to easYgen-3100/3200 (Package P2) devices.*

The easYgen provides three additional freely configurable PID controllers. These controllers are intended and optimized for slow processes, like temperature control for heating systems (CHPO applications). The controller can either operate as a PID analog controller or a three-position controller.

## Configuration

Configure Application > Configure Controller > PID {x} Control

ID	Parameter	CL	Setting range [Default]	Description
16338 16339 16348	<b>Description</b>	2	user-defined  [PID controller {x}]	This text will be displayed on the Setpoints screens. The text may have 1 through 16 characters.
				<b>Notes</b> This parameter may only be configured using ToolKit.
5571 5584 5670	<b>PID{x} control</b>	2	On	The PID controller is enabled.
			[Off]	No control is carried out.
5580 5593 5679	<b>PID{x} ctrl.release</b>	2	Determined by LogicsManager  [[0 & 1] & 1]	If this LogicsManager condition is TRUE, the PID {x} controller will be released.
				<b>Notes</b> For information on the LogicsManager and its default settings see <a href="#">Chapter 9.4.1 "LogicsManager Overview" on page 689</a> .
5572 5585 5671	<b>Proportional gain</b>	2	0.001 to 65.000  [1.000]	The proportional coefficient specifies the gain. By increasing the gain, the response is increased to permit larger corrections to the variable to be controlled.  The farther out of tolerance the process is the larger the response action is to return the process to the tolerance band. If the gain is configured too high, the result is excessive overshoot/undershoot of the desired value.
5573 5586 5672	<b>Integral gain</b>	2	0.010 to 10.000  [0.100]	The integral gain identifies the I part of the PID controller. The integral gain corrects for any offset (between setpoint and process variable) automatically over time by shifting the proportioning band.  The integral gain automatically changes the output signal until the process variable and the setpoint are the same. The integral gain constant must be greater than the derivative time constant.  If the integral gain constant is too large, the engine will continually oscillate. If the integral gain constant is too small, the engine will take too long to settle at a steady state.
5574 5587 5673	<b>Derivative ratio</b>	2	0.001 to 10.000  [0.001]	The derivative ratio identifies the D part of the PID controller. By increasing this parameter, the stability of the system is increased. The controller will attempt to slow down the action of the actuator in an attempt to prevent excessive overshoot or undershoot. Essentially this is the brake for the process.
5575 5588 5674	<b>Time pulse minimum</b>	1	0.01 to 2.00 s  [0.05 s]	A minimum pulse on time must be configured here. The shortest possible pulse time should be configured, but the actuator should still react safe, to limit overshoot of the desired speed reference point. (Only three-position controller)
5576 5589 5675	<b>Deadband</b>	1	0 to 32000  [10]	Shows the adjust range around the setpoint value when no displace impulse is issued. This avoids an unnecessary abrasion of relay contacts for higher/lower. (Only three-position controller)
5578 5591 5677	<b>PID{x} control actual value</b>	2	Determined by AnalogManager  [06.01/02/03]	The PID {x} control actual value may be selected from the available analog data sources. It is possible to select all data sources ( <a href="#">Chapter 9.3.1 "Data Sources" on page 671</a> ).

ID	Parameter	CL	Setting range [Default]	Description
5577 5590 5676	<b>PID{x} control setpoint</b>	2	Determined by AnalogManager [05.25/26/27]	The PID {x} control setpoint source may be selected from the available analog data sources. It is possible to select all data sources ( <a href="#">↪ Chapter 9.3.1 "Data Sources" on page 671</a> ).
5579 5592 5678	<b>Int. PID{x} control setpoint</b>	1	-32000 to 32000 [0]	The internal setpoint is defined in this screen. This value is the reference for the PID {x} controller.
5581 5594 5680	<b>PID{x} control initial state</b>	2	0 to 100 % [50 %]	The value entered for this parameter is the start reference point for the analog output to the controller as long as the LogicsManager is false. If the PID controller has been disabled (e.g. Parameter 5571 <a href="#">↪ p. 348</a> ), the bias output will change to 0 %.
5582 5595 5681	<b>Sampling time</b>	2	1 to 360 s [1 s]	The sampling time is configured here. This is the time between two consecutive samples.  The sampling time shall be configured high enough that the actual value can react in case e.g. a temperature just shifts slowly.
5692 5693 5694	<b>Actuator run time</b>	2	0.1 to 999.0 s [30.0 s]	The actuator run time is configured here. This is the time the actuator needs to move from fully closed to fully open. This information is necessary because the controller does not receive a feedback of the actuator position and needs this value to calculate the desired actuator position.
5734 5735 5736	<b>PID{x} control PI band</b>	1	0 to 32000 [2000]	The PI band is configured here to encounter excessive overshoot of the process value when starting up. The PI band defines the range around the setpoint, in which the I portion of the PID controller is active.  If the actual value is outside of this band, the I portion is reduced to a minimum value. The PI band is not that important for three-position controllers and should be disabled by entering a high value (e.g. default value).
5737 5738 5739	<b>PID{x} control setpoint ramp</b>	2	1 to 32000 [10]	The different setpoint values are supplied to the controller via this ramp to prevent an overshoot of the process value when enabling the controller.  The slope of the ramp is used to alter the rate at which the controller modifies the setpoint value. The faster the change in the setpoint is to be carried out, the greater the value entered here must be.
5740 5741 5742	<b>Value format</b>	2	user-defined (1 to 8 characters text) [000000]	If a sign to denote a negative measured value (i.e. -10) is required, then the first "0" of the numeric display is utilized for this symbol.  To display the controlled setpoint correctly, this parameter is to be used to define the format. The zeros in the numeric display are used for the measuring values and are configurable. The placeholders for the digits may have symbols (i.e. commas).

ID	Parameter	CL	Setting range [Default]	Description
				<p><b>Notes</b></p> <p>This parameter may only be configured using ToolKit.</p> <p>The displayed value should be configured with the same number of digits as the desired value to be measured.</p> <p>The measured value will be displayed from right to left. If the measured value is larger than the number of digits in the display, only a portion of the measured value will be shown.</p> <p>An example of this would be a display of three digits is configured when four digits will be needed. Instead of the number "1234" being displayed only "234" will be shown.</p>
				<p><b>Examples</b></p> <ul style="list-style-type: none"> <li>■ Fuel level: <ul style="list-style-type: none"> <li>– Value at 0 %: 0</li> <li>– Value at 100 %: 1000</li> <li>– Desired display up to 1,000 mm</li> <li>– This parameter: 0,000 mm</li> </ul> </li> <li>■ Angle: <ul style="list-style-type: none"> <li>– Value at 0 %: -1799</li> <li>– Value at 100 %: 1800</li> <li>– Desired display: -179.9° to 180.0°</li> <li>– This parameter: 0000.0°</li> </ul> </li> <li>■ Pressure: <ul style="list-style-type: none"> <li>– Value at 0 %: 0</li> <li>– Value at 100 %: 100</li> <li>– Desired display up to: 10.0 bar</li> <li>– This parameter: 00.0 bar</li> </ul> </li> </ul>

#### 4.5.12.9 Discrete Raise/Low Function

##### General notes

The frequency / load and voltage / reactive power setpoints may be raised and lowered using the LogicsManager functionality, i.e. it is possible to use LogicsManager command variables to raise and lower these setpoints. In this case the discrete raise/lower function always starts with the rated value (frequency / load and voltage / reactive power).

Most commonly a button may be used to energize a discrete input on the control, which is used again as a LogicsManager command variable to enable the respective LogicsManager function to change the setpoint.

Frequency and voltage may be adjusted within the configured operating limits ( ↪ *Chapter 4.4.1.1 "Generator Operating Voltage / Frequency" on page 110*). Active power may be adjusted between 0 and the configured load control setpoint maximum (parameter 5523 ↪ p. 313). The power factor may be adjusted between 0.71 leading and 0.71 lagging.

ID	Parameter	CL	Setting range [Default]	Description
12900	Discrete f/P +	2	Determined by LogicsManager [[0 & 1] & 1]	Once the conditions of the LogicsManager have been fulfilled, the frequency / load setpoint will be raised.
			<b>Notes</b> For information on the LogicsManager and its default settings see <a href="#">Chapter 9.4.1 "LogicsManager Overview" on page 689.</a>	
12901	Discrete f/P -	2	Determined by LogicsManager [[0 & 1] & 1]	Once the conditions of the LogicsManager have been fulfilled, the frequency / load setpoint will be lowered.
			<b>Notes</b> For information on the LogicsManager and its default settings see <a href="#">Chapter 9.4.1 "LogicsManager Overview" on page 689.</a>	
12902	Discrete V/PF +	2	Determined by LogicsManager [[0 & 1] & 1]	Once the conditions of the LogicsManager have been fulfilled, the voltage / reactive power setpoint will be raised.
			<b>Notes</b> For information on the LogicsManager and its default settings see <a href="#">Chapter 9.4.1 "LogicsManager Overview" on page 689.</a>	
12903	Discrete V/PF -	2	Determined by LogicsManager [[0 & 1] & 1]	Once the conditions of the LogicsManager have been fulfilled, the voltage / reactive power setpoint will be lowered.
			<b>Notes</b> For information on the LogicsManager and its default settings see <a href="#">Chapter 9.4.1 "LogicsManager Overview" on page 689.</a>	
5024	Discrete ramp f +/-	2	000.01 ... 100.00 %/s [000.07 %/s]	Configurable ramp rate for frequency setpoint raise and lower commands.
5025	Discrete ramp V +/-	2	000.01 ... 100.00 %/s [000.70 %/s]	Configurable ramp rate for voltage setpoint raise and lower commands.
5026	Discrete ramp P +/-	2	000.01 ... 100.00 %/s [003.00 %/s]	Configurable ramp rate for active power setpoint raise and lower commands.
5027	Discrete ramp Power Factor +/-	2	000.01 ... 100.00 %/s [007.50 %/s]	Configurable ramp rate for Power Factor (PF) setpoint raise and lower commands.

## 4.6 Configure Interfaces

### 4.6.1 CAN Interface 1

#### General notes



The CAN bus is a field bus and subject to various disturbances. Therefore, it cannot be guaranteed that every request will be answered. We recommend to repeat a request, which is not answered within reasonable time.

#### COB-ID messages



Parameters 9100 ↗ p. 354 and 9101 ↗ p. 354 use synchronization and time messages that adhere to the following structure.

UNSIGN ED 32		MSB				LSB
Bits	Bits	31	30	29	28-11	10-0
11 bit ID	11 bit ID	X	0/1	X	0000000 0000000 0000	11 bit identifier

Bit number	Value	Meaning
31 (MSB)	0	Unit does not apply TIME message
	1	Unit applies TIME message
30	0	Unit does not generate SYNC/TIME message
	1	Unit generates SYNC/TIME message
29	X	N/A
28-11	0	Always
10-0 (LSB)	X	Bits 10-0 of SYNC/TIME COB-ID

#### TIME synchronization message

CANopen master	COB-ID TIME	Time applied	Time transmitted
Off	Bit 30 = 0; Bit 31 = 0	No	No
	Bit 30 = 1; Bit 31 = 0	Yes	No
	Bit 30 = 0; Bit 31 = 1	Yes	No
	Bit 30 = 1; Bit 31 = 1	Yes	Yes
Default	Bit 30 = 0; Bit 31 = 0	No	No
	Bit 30 = 1; Bit 31 = 0	No	Yes



CANopen master	COB-ID TIME	Time applied	Time transmitted
	Bit 30 = 0; Bit 31 = 1	Yes	No <sup>1</sup>
	Bit 30 = 1; Bit 31 = 1	Yes	Yes <sup>1</sup>
On	Bit 30 = 0; Bit 31 = 0	No	No
	Bit 30 = 1; Bit 31 = 0	No	Yes
	Bit 30 = 0; Bit 31 = 1	Yes	No
	Bit 30 = 1; Bit 31 = 1	Yes	Yes



<sup>1</sup> If CANopen master (lowest Node-ID).

ID	Parameter	CL	Setting range [Default]	Description
3156	Baudrate	2	20 / 50 / 100 / 125 / 250 / 500 / 800 / 1000 kBaud [250 kBd]	This parameter defines the used baud rate. Please note, that all participants on the CAN bus must use the same baud rate.
8950	Node-ID CAN bus 1	2	1 to 127 (dec) [1]	<p>A number that is unique to the control must be set in this parameter so that this control unit can be correctly identified on the CAN bus.</p> <p>This address number may only be used once on the CAN bus. All additional addresses are calculated based on this unique device number.</p> <p><b>Notes</b></p> <p>We recommend to configure the Node-IDs for units, which participate in load sharing, as low as possible to facilitate establishing of communication.</p> <p>For multiple genset applications please make sure to change parameter 1702 ↪ p. 92 as well</p>
8993	CANopen Master	2		One bus participant must take over the network management and put the other participants into "operational" mode. The easYgen is able to perform this task.
			[Default Master]	The unit starts up in "operational" mode and sends a "Start_Remote_node" message after a short delay (the delay is the Node-ID (parameter 8950 ↪ p. 353) in seconds, i.e. if the Node-ID is configured to 2, the message will be sent after 2 seconds). If more than one easYgen is configured to Default Master, the unit with the lower Node-ID will take over control. Therefore, the CAN bus devices, which are intended to act as Default Master should be assigned a low Node-ID. No other device on the CAN bus (except the easYgens) may operate as Master).
			On	The unit is the CANopen Master and automatically changes into operational mode and transmits data.
			Off	The unit is a CANopen Slave. An external Master must change into operational mode.

ID	Parameter	CL	Setting range [Default]	Description
				<p><b>Notes</b></p> <p>If this parameter is configured to "Off", the Master controller (for example a PLC) must send a "Start_Remote_node" message to initiate the load share message transmission of the easYgen.</p> <p>If no "Start_Remote_node" message would be sent, the complete system would not be operational.</p>
9120	<b>Producer heartbeat time</b>	2	0 to 65500 ms [2000 ms]	<p>Independent from the CANopen Master configuration, the unit transmits a heartbeat message with this configured heartbeat cycle time.</p> <p>If the producer heartbeat time is equal 0, the heartbeat will only be sent as response to a remote frame request. The time configured here will be rounded up to the next 20 ms step.</p>
9100	<b>COB-ID SYNC Message</b>	2	1 to FFFFFFFF hex [80 hex]	<p>This parameter defines whether the unit generates the SYNC message or not.</p> <p>The message complies with CANopen specification: object 1005; subindex 0 defines the COB-ID of the synchronization object (SYNC).</p>
				<p><b>Notes</b></p> <p>The structure of this object is shown in <a href="#">☞ "COB-ID messages" on page 352</a></p>
8940	<b>Producer SYNC Message time</b>	2	0 to 65000 ms [20 ms]	<p>This is the cycle time of the SYNC message. If the unit is configured for this function (parameter 9100 <a href="#">☞ p. 354</a>) it will send the SYNC message with this interval. The time configured here will be rounded up to the next 10 ms step.</p>
9101	<b>COB-ID TIME Message</b>	2	1 to FFFFFFFF hex [100 hex]	<p>This parameter defines whether the unit generates the TIME message or not.</p> <p>Complies with CANopen specification: object 1012, subindex 0; defines the COB-ID of the time object (TIME).</p>
				<p><b>Notes</b></p> <p>The structure of this object is shown in <a href="#">☞ "COB-ID messages" on page 352</a></p>
9102	<b>Cycle of TIME sync. message</b>	2	1.0 to 6500.0 s [10.0 s]	<p>This is the cycle time of the TIME message. If the unit is configured for this function (parameter 9101 <a href="#">☞ p. 354</a>) it will send the TIME message with this interval.</p>
				<p><b>Notes</b></p> <p>The structure of this object is shown in <a href="#">☞ "TIME synchronization message" on page 352</a></p>

4.6.1.1 Additional Server SDOs (Service Data Objects)

General notes



*The CAN bus is a field bus and subject to various disturbances. Therefore, it cannot be guaranteed that every request will be answered. We recommend to repeat a request, which is not answered within reasonable time.*

The first Node-ID is the standard Node-ID of CAN interface 1 (parameter 8950 [☞ p. 353](#)).

ID	Parameter	CL	Setting range [Default]	Description
33040	<b>2. Node-ID</b>	2	0 to 127 (dec) [0]	In a multi-master application, each Master needs its own identifier (Node-ID) from the unit. in order to send remote signals (i.e. remote start, stop, shut-down, or acknowledge) to the unit.  The additional SDO channel will be made available by configuring this Node-ID to a value different than zero. This is the additional CAN ID for the PLC.
33041	<b>3. Node-ID</b>	2	0 to 127 (dec) [0]	In a multi-master application, each Master needs its own identifier (Node-ID) from the unit. in order to send remote signals (i.e. remote start, stop, shut-down, or acknowledge) to the unit.  The additional SDO channel will be made available by configuring this Node-ID to a value different than zero. This is the additional CAN ID for the PLC.
33042	<b>4. Node-ID</b>	2	0 to 127 (dec) [0]	In a multi-master application, each Master needs its own identifier (Node-ID) from the unit. in order to send remote signals (i.e. remote start, stop, shut-down, or acknowledge) to the unit.  The additional SDO channel will be made available by configuring this Node-ID to a value different than zero. This is the additional CAN ID for the PLC.
33043	<b>5. Node-ID</b>	2	0 to 127 (dec) [0]	In a multi-master application, each Master needs its own identifier (Node-ID) from the unit. in order to send remote signals (i.e. remote start, stop, shut-down, or acknowledge) to the unit.  The additional SDO channel will be made available by configuring this Node-ID to a value different than zero. This is the additional CAN ID for the PLC.

#### 4.6.1.2 Receive PDO {x} (Process Data Object)

##### General notes

RPDO mapping is carried out as shown in ( Fig. 112).

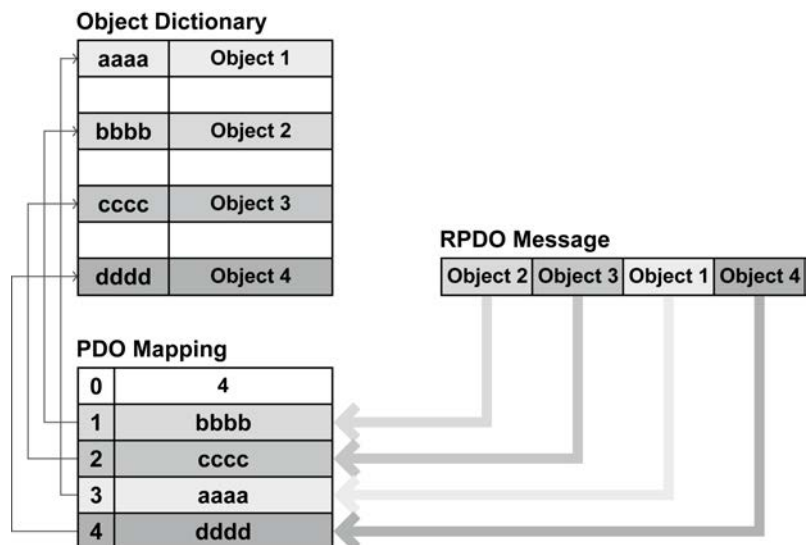

Fig. 112: RPDO mapping principle

COB-ID parameters



**Parameters**

9300 ↗ p. 356/9310 ↗ p. 356/9320 ↗ p. 356/33330 ↗ p. 356/33340 ↗ p. 356 use communication parameters that adhere to the following structure.

RPDO Objects can be remote signals (parameter 503; please refer to ↗ “Remote control word 1” on page 663 for details), DI states and AI measured values.



UNSIGN D 32		MSB				LSB
Bits	Bits	31	30	29	28-11	10-0
11 bit ID	11 bit ID	0/1	X	X	0000000 0000000 0000	11 bit identifier

Bit number	Value	Meaning
31 (MSB)	0	PDO exists / is valid
	1	PDO does not exist / is not valid
30	X	N/A
29	X	N/A
28-11	0	Always
10-0 (LSB)	X	Bits 10-0 of COB-ID



PDO valid / not valid allows to select, which PDOs are used in the operational state.

ID	Parameter	CL	Setting range [Default]	Description
9300 9310 9320 33330 33340	COB-ID	2	1 to FFFFFFFF hex	This parameter contains the communication parameters for the PDOs, the device is able to receive.
[80000000 hex]			Complies with CANopen specification: object 1400 (for RPDO 1, 1401 for RPDO 2, 1402 for RPDO 3, 1403 for RPDO 4, and 1404 for RPDO 5), sub-index 1.	
<b>Notes</b>			The structure of this object is shown in ↗ “COB-ID parameters” on page 356.  Do not configure an RPDO or TPDO with a COB-ID higher than 580 (hex) or lower than 180 (hex). These IDs are reserved for internal purposes.	

ID	Parameter	CL	Setting range [Default]	Description	
9121	<b>Event-timer</b>	2	0 to 65500 ms	This parameter configures the time, from which this PDO is marked as "not existing". The time configured here will be rounded up to the next 5 ms step. Received messages are processed by the control unit every 20 ms. Messages, which are sent faster, will be discarded. We recommend to configure ten times the cycle time of the received data here.	
9122			[2000 ms]		
9123					
9124					
9125					
				<b>Notes</b> Complies with CANopen specification: object 1400 (for RPDO 1, 1401 for RPDO 2, 1402 for RPDO 3, 1403 for RPDO 4, and 1404 for RPDO 5), sub-index 5	
8970	<b>Selected Data Protocol</b>	2	0 to 65535	A data protocol may be selected by entering the data protocol ID here. If 0 is configured here, the message assembled by the mapping parameters is used. If an unknown data protocol ID is configured here, a failure is indicated by the CAN status bits. Possible data protocol IDs are:	
8971			[0]		
8972					
8973			65000		IKD 1 – external DIs/DOs 1 through 8
8974			65001		IKD 1 – external DIs/DOs 9 through 16
	65002	 only: IKD 1 – external DIs/DOs 17 through 24			
	65003	 only: IKD 1 – external DIs/DOs 25 through 32			
9910	<b>Number of Mapped Objects</b>	2	0 to 4	This parameter defines the number of valid entries within the mapping record. This number is also the number of the application variables, which shall be received with the corresponding PDO.	
33855			[0]		
33860					
33865					
33870					
				<b>Notes</b> Complies with CANopen specification: object 1600 (for RPDO 1, 1601 for RPDO 2, 1602 for RPDO 3, 1603 for RPDO 4, and 1604 for RPDO 5), sub-index 0	
9911	<b>1. Mapped Object</b>	2	0 to 65535	This parameter contains the information about the mapped application variables. These entries describe the PDO contents by their index. The sub-index is always 1. The length is determined automatically.	
9916			[0]		
9906					
33866					
33871					
				<b>Notes</b> Complies with CANopen specification: object 1600 (for RPDO 1, 1601 for RPDO 2, 1602 for RPDO 3, 1603 for RPDO 4, and 1604 for RPDO 5), sub-index 1.	
9912	<b>2. Mapped Object</b>	2	0 to 65535	This parameter contains the information about the mapped application variables. These entries describe the PDO contents by their index. The sub-index is always 1. The length is determined automatically.	
9917			[0]		
9907					
33867					
33872					
				<b>Notes</b> Complies with CANopen specification: object 1600 (for RPDO 1, 1601 for RPDO 2, 1602 for RPDO 3, 1603 for RPDO 4, and 1604 for RPDO 5), sub-index 2.	
9913	<b>3. Mapped Object</b>	2	0 to 65535	This parameter contains the information about the mapped application variables. These entries describe the PDO contents by their index. The sub-index is always 1. The length is determined automatically.	
9918			[0]		
9908					
33868					
33873					
				<b>Notes</b> Complies with CANopen specification: object 1600 (for RPDO 1, 1601 for RPDO 2, 1602 for RPDO 3, 1603 for RPDO 4, and 1604 for RPDO 5), sub-index 3.	

ID	Parameter	CL	Setting range [Default]	Description
9914	<b>4. Mapped Object</b>	2	0 to 65535 [0]	This parameter contains the information about the mapped application variables. These entries describe the PDO contents by their index. The sub-index is always 1. The length is determined automatically.
9919				<b>Notes</b>  Complies with CANopen specification: object 1600 (for RPDO 1, 1601 for RPDO 2, 1602 for RPDO 3, 1603 for RPDO 4, and 1604 for RPDO 5), sub-index 4.
9909				
33869				
33874				

4.6.1.3 Transmit PDO {x} (Process Data Object)

General notes

TPDO mapping is carried out as shown in ( Fig. 113).

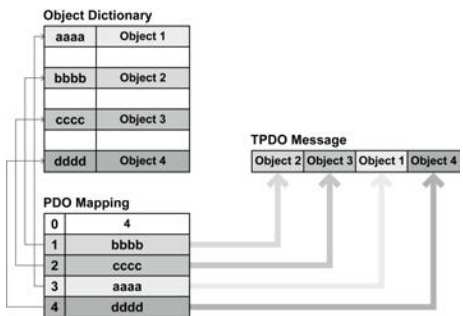

Fig. 113: TPDO mapping



*CANopen allows to send 8 byte of data with each Transmit PDO. These may be defined separately if no pre-defined data protocol is used.*

*All data protocol parameters with a parameter ID may be sent as an object with a CANopen Transmit PDO.*

*The data length will be taken from the data byte column (see Chapter 9.2 “Data Protocols” on page 563):*

- 1,2 UNSIGNED16 or SIGNED16
- 3,4 UNSIGNED16 or SIGNED16
- 5,6 UNSIGNED16 or SIGNED16
- 1,2,3,4 UNSIGNED32 or SIGNED32
- 3,4,5,6 UNSIGNED32 or SIGNED32
- etc.

*The object ID is identical with the parameter ID when configuring via front panel or Toolkit.*

COB-ID parameters



*Parameters*

*9600 ↪ p. 360/9610 ↪ p. 360/9620 ↪ p. 360/9630 ↪ p. 360/33640 ↪ p. 360 use communication parameters that adhere to the following structure.*

UNSIGN ED 32		MSB				LSB
Bits	Bits	31	30	29	28-11	10-0
11 bit ID	11 bit ID	0/1	X	X	0000000 0000000 0000	11 bit identifier

Bit number	Value	Meaning
31 (MSB)	0	PDO exists / is valid
	1	PDO does not exist / is not valid
30	X	N/A
29	X	N/A
28-11	0	Always
10-0 (LSB)	X	Bits 10-0 of COB-ID



*PDO valid / not valid allows to select, which PDOs are used in the operational state.*

### Transmission types



**Parameters**

*9602 ↗ p. 360/9612 ↗ p. 360/9622 ↗ p. 360/9632 ↗ p. 360/33642 ↗ p. 360 are used to select one of the following transmission types.*

Transmission type	PDO transmission				
	Cyclic	Acyclic	Synchronous	Asynchronous	RTR only
0	Will not be sent				
1-240	X		X		
241-251	Will not be sent				
252	Will not be sent				
253	Will not be sent				
254				X	
255				X	



*A value between 1 and 240 means that the PDO is transferred synchronously and cyclically. The transmission type indicating the number of SYNC, which are necessary to trigger PDO transmissions.*

*Receive PDOs are always triggered by the following SYNC upon reception of data independent of the transmission types 0 to 240. For TPDOs, transmission type 254 and 255 means, the application event is the event timer.*

## Configuration

Configure Interfaces > CAN Interface 1 > Transmit PDO {x} (Process ...

ID	Parameter	CL	Setting range [Default]	Description
9600 9610 9620 9630 33640	<b>COB-ID</b>	2	1 to FFFFFFFF hex  [80000000 hex]	This parameter contains the communication parameters for the PDOs the unit is able to transmit. The unit transmits data (i.e. visualization data) on the CAN ID configured here.  Complies with CANopen specification: object 1800 for (TPDO 1, 1801 for TPDO 2, 1802 for TPDO 3, 1803 for TPDO 4, and 1804 for TPDO 5), sub-index 1.
<b>Notes</b> The structure of this object is shown in <a href="#">☞ “COB-ID parameters” on page 358</a> Do not configure an RPDO or TPDO with a COB-ID higher than 580 (hex) or lower than 180 (hex). These IDs are reserved for internal purposes. In case a LSG is part of CAN 1, do not configure COB-IDs 181 - 18E (hex) because legacy devices are using same IDs but cannot be switched.				
9602 9612 9622 9632 33642	<b>Transmission type</b>	2	0 to 255  [255]	This parameter contains the communication parameters for the PDOs the unit is able to transmit. It defines whether the unit broadcasts all data automatically (value 254 or 255) or only upon request with the configured address of the COB-ID SYNC message (parameter 9100 <a href="#">☞ p. 354</a> ).
<b>Notes</b> Complies with CANopen specification: object 1800 (for TPDO 1, 1801 for TPDO 2, 1802 for TPDO 3, 1803 for TPDO 4, and 1804 for TPDO 5), sub-index 2. The description of the transmission type is shown in <a href="#">☞ “Transmission types” on page 359</a> .				
9604 9614 9624 9634 33644	<b>Event timer</b>	2	0 to 65500 ms  [20 ms]	This parameter contains the communication parameters for the PDOs the unit is able to transmit. The broadcast cycle for the transmitted data is configured here. The time configured here will be rounded up to the next 5 ms step.
<b>Notes</b> Complies with CANopen specification: object 1800 (for TPDO 1, 1801 for TPDO 2, 1802 for TPDO 3, 1803 for TPDO 4, and 1804 for TPDO 5), sub-index 5				
8962 8963 8964 8965 8966	<b>Selected Data Protocol</b>	2	0 to 65535  8962: [5003] 8963: [5008] 8964: [5009] 8965: [0] 8966: [0]	A data protocol may be selected by entering the data protocol ID here. If 0 is configured here, the message assembled by the mapping parameters is used. If an unknown data protocol ID is configured here, a failure is indicated by the CAN status bits.  Possible data protocol IDs are:
65000			IKD 1 – external DIs/DOs 1 through 8	
65001			IKD 1 – external DIs/DOs 9 through 16	
65002			IKD 1 – external DIs/DOs 17 through 24	
65003			IKD 1 – external DIs/DOs 25 through 32	
5003			Data telegram (CAN and MODBUS)	
5005			Data telegram (CAN mains values)	
5010			Data telegram (MODBUS)	
5011			Data telegram (CAN alarm values )	



ID	Parameter	CL	Setting range [Default]	Description
			4103	Data telegram (CAN J1939)
			4104	Data telegram (CAN J1939 Scania S6)
			4105	Data telegram (CAN J1939 Deutz EMR2)
			4110	Data telegram (CAN J1939 MTU ADEC)
9609 9619 9629 9639 33649	<b>Number of Mapped Objects</b>	2	0 to 4 [0]	This parameter contains the mapping for the PDOs the unit is able to transmit. This number is also the number of the application variables, which shall be transmitted with the corresponding PDO.  <b>Notes</b> Complies with CANopen specification: object 1A00 (for TPDO 1, 1A01 for TPDO 2, 1A02 for TPDO 3, 1A03 for TPDO 4, and 1A04 for TPDO 5), sub-index 0
9605 9615 9625 9635 33645	<b>1. Mapped Object</b>	2	0 to 65535 [0]	This parameter contains the information about the mapped application variables. These entries describe the PDO contents by their index. The sub-index is always 1. The length is determined automatically.  <b>Notes</b> Complies with CANopen specification: object 1A00 (for TPDO 1, 1A01 for TPDO 2, 1A02 for TPDO 3, 1A03 for TPDO 4, and 1A04 for TPDO 5), sub-index 1
9606 9616 9626 9636 33646	<b>2. Mapped Object</b>	2	0 to 65535 [0]	This parameter contains the information about the mapped application variables. These entries describe the PDO contents by their index. The sub-index is always 1. The length is determined automatically.  <b>Notes</b> Complies with CANopen specification: object 1A00 (for TPDO 1, 1A01 for TPDO 2, 1A02 for TPDO 3, 1A03 for TPDO 4, and 1A04 for TPDO 5), sub-index 2
9607 9617 9627 9637 33647	<b>3. Mapped Object</b>	2	0 to 65535 [0]	This parameter contains the information about the mapped application variables. These entries describe the PDO contents by their index. The sub-index is always 1. The length is determined automatically.  <b>Notes</b> Complies with CANopen specification: object 1A00 (for TPDO 1, 1A01 for TPDO 2, 1A02 for TPDO 3, 1A03 for TPDO 4, and 1A04 for TPDO 5), sub-index 3
9608 9618 9628 9638 33648	<b>4. Mapped Object</b>	2	0 to 65535 [0]	This parameter contains the information about the mapped application variables. These entries describe the PDO contents by their index. The sub-index is always 1. The length is determined automatically.  <b>Notes</b> Complies with CANopen specification: object 1A00 (for TPDO 1, 1A01 for TPDO 2, 1A02 for TPDO 3, 1A03 for TPDO 4, and 1A04 for TPDO 5), sub-index 4

## 4.6.2 CAN Interface 2

### General notes



*The CAN bus is a field bus and subject to various disturbances. Therefore, it cannot be guaranteed that every request will be answered. We recommend to repeat a request, which is not answered within reasonable time.*

ID	Parameter	CL	Setting range [Default]	Description
3157	Baudrate	2	20 / 50 / 100 / 125 / 250 kBaud  [250 kBd]	This parameter defines the used baud rate. Please note, that all participants on the CAN bus must use the same baud rate.

### 4.6.2.1 CANopen Interface

ID	Parameter	CL	Setting range [Default]	Description
9940	This device	2	Node-ID 1 / 2 / 3 / 4 / 5 / 6 / 7  [Node-ID 7]	The Node-ID for the control unit (this device) is configured here.
9930	IKD1 DI/DO 1..8	2	Off / Node-ID 1 / 2 / 3 / 4 / 5 / 6 / 7  [Off]	The unit is pre-configured for the connection of a Woodward IKD 1 expansion board with the discrete inputs/outputs 1 through 8 by configuring a Node-ID here.
9931	IKD1 DI/DO 9..16	2	Off / Node-ID 1 / 2 / 3 / 4 / 5 / 6 / 7  [Off]	The unit is pre-configured for the connection of a Woodward IKD 1 expansion board with the discrete inputs/outputs 9 through 16 by configuring a Node-ID here.
9932	only: IKD1 DI/DO 17..24	2	Off / Node-ID 1 / 2 / 3 / 4 / 5 / 6 / 7  [Off]	The unit is pre-configured for the connection of a Woodward IKD 1 expansion board with the discrete inputs/outputs 17 through 24 by configuring a Node-ID here.
9933	only: IKD1 DI/DO 25..32	2	Off / Node-ID 1 / 2 / 3 / 4 / 5 / 6 / 7  [Off]	The unit is pre-configured for the connection of a Woodward IKD 1 expansion board with the discrete inputs/outputs 25 through 32 by configuring a Node-ID here.
9934	Phoenix DI/DO 1..16	2	Off / Node-ID 1 / 2 / 3 / 4 / 5 / 6 / 7  [Off]	The unit is pre-configured for the connection of a Phoenix Contact expansion board with the discrete inputs/outputs 1 through 16 by configuring a Node-ID here.

ID	Parameter	CL	Setting range [Default]	Description
9935	 only: <b>Phoenix DI/DO 17..32</b>	2	Off / Node-ID 1 / 2 / 3 / 4 / 5 / 6 / 7  [Off]	The unit is pre-configured for the connection of a Phoenix Contact expansion board with the discrete inputs/outputs 17 through 32 by configuring a Node-ID here.
9936	 only: <b>Phoenix DI/DO 1..32</b>	2	Off / Node-ID 1 / 2 / 3 / 4 / 5 / 6 / 7  [Off]	The unit is pre-configured for the connection of a Phoenix Contact expansion board with the discrete inputs/outputs 1 through 32 by configuring a Node-ID here.
9943	 only: <b>Phoenix 4AI 4AO</b>	2	Off / Node-ID 1 / 2 / 3 / 4 / 5 / 6 / 7  [Off]	The unit is pre-configured for the connection of a Phoenix Contact expansion board with 4 analog inputs and 4 analog outputs by configuring a Node-ID here.
9942	 only: <b>Phoenix 8AI 4AO</b>	2	Off / Node-ID 1 / 2 / 3 / 4 / 5 / 6 / 7  [Off]	The unit is pre-configured for the connection of a Phoenix Contact expansion board with 8 analog inputs and 4 analog outputs by configuring a Node-ID here.
9941	 only: <b>Phoenix 12AI 4AO</b>	2	Off / Node-ID 1 / 2 / 3 / 4 / 5 / 6 / 7  [Off]	The unit is pre-configured for the connection of a Phoenix Contact expansion board with 12 analog inputs and 4 analog outputs by configuring a Node-ID here.
9937	 only: <b>Phoenix 16AI 4AO</b>	2	Off / Node-ID 1 / 2 / 3 / 4 / 5 / 6 / 7  [Off]	The unit is pre-configured for the connection of a Phoenix Contact expansion board with 16 analog inputs and 4 analog outputs by configuring a Node-ID here.
9944	 only: <b>Phoenix 4AI 4AO DI/DO 1..32</b>	2	Off / Node-ID 1 / 2 / 3 / 4 / 5 / 6 / 7  [Off]	The unit is pre-configured for the connection of a Phoenix Contact expansion board with the discrete inputs/outputs 1 through 32 and 4 analog inputs and 4 analog outputs by configuring a Node-ID here.
9945	 only: <b>Phoenix 8AI 4AO DI/DO 1..32</b>	2	Off / Node-ID 1 / 2 / 3 / 4 / 5 / 6 / 7  [Off]	The unit is pre-configured for the connection of a Phoenix Contact expansion board with the discrete inputs/outputs 1 through 32 and 8 analog inputs and 4 analog outputs by configuring a Node-ID here.
9946	 only: <b>Phoenix 12AI 4AO DI/DO 1..32</b>	2	Off / Node-ID 1 / 2 / 3 / 4 / 5 / 6 / 7  [Off]	The unit is pre-configured for the connection of a Phoenix Contact expansion board with the discrete inputs/outputs 1 through 32 and 12 analog inputs and 4 analog outputs by configuring a Node-ID here.
9938	 only: <b>Phoenix 16AI 4AO DI/DO 1..32</b>	2	Off / Node-ID 1 / 2 / 3 / 4 / 5 / 6 / 7  [Off]	The unit is pre-configured for the connection of a Phoenix Contact expansion board with the discrete inputs/outputs 1 through 32 and 16 analog inputs and 4 analog outputs by configuring a Node-ID here.
9939	<b>RemoteDisplay</b>	2	Off / Node-ID 1 / 2 / 3 / 4 / 5 / 6 / 7  [Off]	The unit is pre-configured for the connection of a Woodward Remote Display (RP-3000) by configuring a Node-ID here.
15134	<b>Configure external devices</b>	2	Yes  [No]	This parameter starts the configuration of external Phoenix expansion boards.

ID	Parameter	CL	Setting range [Default]	Description
				<p><b>Instructions</b></p> <p>Proceed as follows to configure an external device:</p> <ul style="list-style-type: none"> <li>■ Connect external device</li> <li>■ Configure parameters at the easYgen (Node-ID, DI/Os, AI/Os)</li> <li>■ Set this parameter to "Yes"</li> <li>■ Verify the successful configuration of the external device</li> </ul>
				<p><b>Notes</b></p> <p>This parameter can only be used to configure a Phoenix expansion board. Refer to the IKD 1 Manual 37135 for configuring the IKD 1 expansion boards.</p>

## 4.6.2.2 J1939 Interface

### General notes



For additional information refer to [Chapter 7.5 “J1939 Protocol”](#) on page 526.



The CAN bus load caused by the J1939 protocol is indicated in menu “Next Page → Diagnostic → Miscellaneous → CAN Load diagnostic”. We recommend not to exceed a bus load of 70 %.

ID	Parameter	CL	Setting range [Default]	Description
15102	Device type	2		<p>The J1939 interface of this device may be operated with different engine control units or analog input devices.</p> <p>This parameter determines the type of the used ECU.</p>
			Off	The J1939 interface is disabled. No messages will be received.
			[Standard]	<p>Standard J1939 coupling is enabled: J1939 data is displayed according to the SAE J1939 standard.</p> <p>This setting must be configured for all J1939 ECUs, which cannot be selected here (e.g. Deutz (EMR3 &amp; EMR4), John Deere, Daimler, Perkins, Iveco, Caterpillar, Liebherr, etc.).</p> <p>Please refer to <a href="#">Chapter 7.5 “J1939 Protocol”</a> on page 526 for details.</p>
			S6 Scania	The Scania EMS/S6 ECU is enabled: J1939 data according to the SAE J1939 standard and some S6-specific data are considered.
			EMR2 Deutz	<p>The Deutz EMR2 ECU is enabled: J1939 data according to the SAE J1939 standard and some EMR2-specific data are considered.</p> <p>This setting is also recommended for Volvo EDC4.</p>
EMS2 Volvo	<p>The Volvo EMS2 ECU is enabled: J1939 data according to the SAE J1939 standard and some EMS2-specific data are considered.</p> <p>This setting is also recommended for Volvo EDC3 and EMS1.</p>			

ID	Parameter	CL	Setting range [Default]	Description
			ADEC ECU7 MTU	The MTU ADEC ECU7 with SAM is enabled: J1939 data according to the SAE J1939 standard and some ADEC-specific data are considered.
			EGS Woodward	The Woodward EGS ECU is enabled: J1939 data according to the SAE J1939 standard and some EGS-specific data are considered.
			MFR/EDC7 MAN	The MAN MFR/EDC7 ECU is enabled: J1939 data according to the SAE J1939 standard and some EDC-specific data are considered.
			EEM SISU	The SISU EEM2/3 ECU is enabled: J1939 data according to the SAE J1939 standard and some EEM2/3-specific data are considered.
			Cummins	The Cummins ECU is enabled: J1939 data according to the SAE J1939 standard and some Cummins-specific data are considered.  This setting is also recommended for Cummins CM570 and CM850.
			ADEC ECU8 MTU	The MTU ADEC ECU8 with SmartConnect is enabled: J1939 data according to the SAE J1939 standard and some ADEC-specific data are considered.
15106	<b>J1939 own address</b>	2	0 to 255 [234]	<p>The easYgen sends J1939 request and control messages with this source address. It must be changed for different ECU types according to the following table. The ECU listens only to control messages, if they are sent to the correct address.</p> <ul style="list-style-type: none"> <li>■ S6 Scania: 39</li> <li>■ EMR2 Deutz: 3</li> <li>■ EMS2 Volvo: 17</li> <li>■ ADEC ECU7 MTU: 1</li> <li>■ EGS Woodward: 234</li> <li>■ MFR/EDC7 MAN: 253</li> <li>■ EEM SISU: N/A</li> <li>■ Cummins: 220</li> <li>■ ADEC ECU8 MTU: 234</li> <li>■ Standard: Please refer to <a href="#">Chapter 7.5 “J1939 Protocol” on page 526</a> and to the manual of your J1939 ECU manufacturer.</li> </ul> <p>Details may be found in the manual of the genset control and in <a href="#">Chapter 7.5 “J1939 Protocol” on page 526</a>.</p>
				<p><b>Notes</b></p> <p>Changing this parameter becomes only effective after restarting the unit.</p>

## Configuration

### Configure Interfaces > CAN Interface 2 > J1939 Interface

ID	Parameter	CL	Setting range [Default]	Description
15107	Engine control address	2	0 to 255 [0]	<p>Configures the address of the J1939 device, which is controlled. The easYgen sends J1939 request and control messages with this destination address.</p> <ul style="list-style-type: none"> <li>■ S6 Scania: 0</li> <li>■ EMR2 Deutz: 0</li> <li>■ EMS2 Volvo: 0</li> <li>■ ADEC ECU7 MTU: 128</li> <li>■ EGS Woodward: 0</li> <li>■ MFR/EDC7 MAN: 39</li> <li>■ EEM SISU: 0/(1)</li> <li>■ Cummins: 0</li> <li>■ ADEC ECU8 MTU: 0</li> <li>■ Standard: Please refer to <a href="#">Chapter 7.5 "J1939 Protocol" on page 526</a> and to the manual of your J1939 ECU manufacturer.</li> </ul> <p>Details may be found in the manual of the genset control and in <a href="#">Chapter 7.5 "J1939 Protocol" on page 526</a>.</p>
15108	Reset previous act. DTCs - DM3	2	Yes [No]	<p>If this parameter is set to "Yes", a DM3 message "Acknowledge passive faults" is sent. After that this parameter is reset automatically to "No".</p> <p>As a result the alarms DTCs (Diagnostic Trouble Codes) of (DM2) which no longer apply are cleared.</p>
15133	Reset act. DTCs - DM11	2	Yes [No]	<p>If this parameter is set to "Yes", a DM11 message "Acknowledge active faults" is sent. After that this parameter is reset automatically to "No".</p> <p>As a result the alarms DTCs (Diagnostic Trouble Codes) of (DM1) which no longer apply are cleared.</p>
15103	SPN version	2	Version 1 / 2 / 3 [Version 1]	<p>The J1939 protocol provides 4 different versions for the conversion method of the Suspect Parameter Number (SPN). This is important for a correct interpretation of the alarm messages (DM1 &amp; DM2).</p> <p>This parameter defines the version of the conversion method: Version 1, Version 2 or Version 3. Version 4 is detected automatically.</p> <p>For details please refer to the manual of your J1939 ECU manufacturer.</p>
15156	Logging DM1	2		<p>Most of the J1939 devices release a standardized DM1 message as an error message on the CAN bus. These messages can be entered into the event list of the easYgen.</p> <p>A J1939 device can monitor the states of his inputs. When a error occurs a DM1 message is released.</p>
			[On]	DM1 messages will be recorded in the event list.
			Off	DM1 messages will be not recorded in the event list.
				<p><b>Notes</b></p> <p>Only known SPNs can be recorded in the event list. These are J1939 Standard SPNs which also can be visualized. Manufacturer specific SPNs will be ignored.</p>
15127	ECU remote controlled	2	[On]	The unit sends J1939 control messages to the ECU. Depending on the selected device type (parameter 15102 <a href="#">p. 364</a> ), contains a specific selection of commands.
			Off	The ECU remote control via the J1939 protocol will be disabled.

ID	Parameter	CL	Setting range [Default]	Description
				<p><b>Notes</b></p> <p>The unit sends J1939 control messages to the ECU. Depending on the selected device type (parameter 15102 ↗ p. 364), it contains a specific selection of commands. Available messages are speed deviation and droop for ECUs as well as engine start/stop, enable idle mode, rated speed switch and preglow for some ECUs.</p> <p>Refer to ↗ <i>Chapter 7.5 "J1939 Protocol" on page 526</i> for more detailed information.</p>
5537	<b>Speed deviation ECU</b>	2	0 to 1,400 rpm [120 rpm]	<p>This parameter adjusts the range of the speed deviation around the rated speed, which is sent to the ECU.</p> <p>It relates to the engine rated speed (parameter 1601 ↗ p. 95).</p> <p>There are two methods of sending the speed setpoint to the ECU: With a speed offset and a speed setpoint. The frequency and power control must be configured to "PID".</p> <p><b>Speed offset</b></p> <p>(S6 Scania, EMS2 Volvo, EGS Woodward, Cummins)</p> <p>The easYgen sends a speed offset with a range of 0 to 100 % (every 20 ms). 50 % = rated speed.</p> <p>There is also an internal speed offset configured in the ECU, this parameter determines what corresponds with 0 % or 100 %. If there is a positive and a negative speed offset, they should be symmetrical in the ECU.</p> <p>We recommend to have the same speed offset configured in the ECU and in this parameter here. A different setting will result in an additional "controller gain".</p> <p>How to test this parameter during commissioning:</p> <p><b>Isolated operation</b></p> <p>Disable the frequency controller and change parameter 5508 ↗ p. 302 for the initial state between 0 and 100 %, the engine should change the speed as follows:</p> <ul style="list-style-type: none"> <li>■ 0 = rated speed – negative speed offset from ECU</li> <li>■ 50 = rated speed</li> <li>■ 100 = rated speed + positive speed offset from ECU</li> </ul> <p><b>Mains parallel operation</b></p> <p>Check with the setpoint in the display if the engine is able to deliver the full power.</p>

ID	Parameter	CL	Setting range [Default]	Description
				<p><b>Speed setpoint</b></p> <p>(EMR2 Deutz, ADEC MTU, EGS Woodward, EEM SISU, Standard)</p> <p>The easYgen sends a speed setpoint in rpm (every 10 ms) that varies around the rated speed in the range of +/- the speed deviation.</p> <p>How to test this parameter during commissioning:</p> <p><b>Isolated operation</b></p> <p>Disable the frequency controller and change parameter 5508 ↗ p. 302 for the initial state between 0 and 100 %, the engine should change the speed as follows:</p> <ul style="list-style-type: none"> <li>■ 0 = rated speed – speed deviation ECU e.g.: 1,500 – 120 = 1,380 rpm</li> <li>■ 50 = rated speed e.g.: = 1,500 rpm</li> <li>■ 100 = rated speed + speed deviation ECU e.g.: 1,500 + 120 = 1,620 rpm</li> </ul> <p><b>Mains parallel operation</b></p> <p>Check with the setpoint in the display if the engine is able to deliver the full power.</p> <p>Keep this value as small as possible, i.e. do not enter a speed deviation of 500, if the engine varies only between 1,400 and 1,600 rpm.</p>
				<p><b>Notes</b></p> <p>The Woodward EGS ECU supports both types of speed deviation control and may be configured either to "Speed offset" or "Speed setpoint".</p> <p>In mains parallel operation, the EGS can be configured to receive a real power setpoint from the easYgen to control the power. In this case, real power control must be disabled in the easYgen.</p> <p>This parameter is only visible if ECU remote controlled (parameter 15127 ↗ p. 366) is configured to "On".</p>
4843	ECU application	2	[Continuous]	Prepared for MTU - 3B mode
			Emergency	Prepared for MTU - 3D mode
				<p><b>Notes</b></p> <p>For details please refer to the manual of your J1939 ECU manufacturer.</p> <p>This parameter is only visible if "Device type" (parameter 15102 ↗ p. 364) is configured to "ADEC ECU8 MTU" and "ECU remote controlled" (parameter 15127 ↗ p. 366) is configured to "On".</p>
12939	ECU power mode	2	[Low power mode]	Prepared for MTU - Low mode
			High power mode	Prepared for MTU - High mode
				<p><b>Notes</b></p> <p>For details please refer to the manual of your J1939 ECU manufacturer.</p> <p>This parameter is only visible if "Device type" (parameter 15102 ↗ p. 364) is configured to "ADEC ECU8 MTU" and "ECU remote controlled" (parameter 15127 ↗ p. 366) is configured to "On".</p>



### 4.6.3 Load Share Parameters

ID	Parameter	CL	Setting range [Default]	Description
9923	Load share Interface	2		The interface, which is used for transmitting the load share data is configured here.
			[CAN #1]	Use CAN interface 1.
			Off	Deactivate load share interface.
9921	Transfer rate LS fast message	2	0.10 to 0.30 s [0.10 s]	The transfer rate defines the time delay between two fast CAN messages.  In case of CAN systems with a high bus load (e.g. long distance between the units with low baud rate), a shorter transfer rate (higher time setting) helps to reduce the bus load.
9920	Load Share CAN-ID	2	2xx Hex / 3xx Hex / 4xx Hex / 5xx Hex [5xx Hex]	The first digit of the CAN ID or the range (i.e. 2xx means 200 through 2FF) is configured here.  The last two digits will be assigned by the control with the settings from the device number (parameter 1702 ↗ p. 92).

### 4.6.4 RS-232 Interface

ID	Parameter	CL	Setting range [Default]	Description
3163	Baudrate	2	2.4 / 4.8 / 9.6 / 14.4 / [19.2] / 38.4 / 56 / 115 kBaud	This parameter defines the baud rate for communications. Please note, that all participants on the bus must use the same baud rate.
3161	Parity	2	[No] / Even / Odd	The used parity of the interface is set here.
3162	Stop bits	2	[One] / Two	The number of stop bits is set here.
7900	Enable Modbus protocol	2	[Yes]	The Modbus protocol is enabled.
			No	The Modbus protocol is disabled.
3185	ModBus Slave ID	2	0 to 255 [1]	The Modbus device address, which is used to identify the device via Modbus, is entered here.  If "0" is configured here, the Modbus is disabled.
3186	Reply delay time	2	0.00 to 1.00 s [0.00 s]	This is the minimum delay time between a request from the Modbus master and the sent response of the slave.  This time is also required if an external interface converter to RS-485 is used for example.

### 4.6.5 RS-485 Interface

ID	Parameter	CL	Setting range [Default]	Description
3170	Baudrate	2	2.4 / 4.8 / 9.6 / 14.4 / <b>[19.2]</b> / 38.4 / 56 / 115 kBaud	This parameter defines the baud rate for communications. Please note, that all participants on the bus must use the same baud rate.
3171	Parity	2	<b>[No]</b> / Even / Odd	The used parity of the interface is set here.
3172	Stop bits	2	<b>[One]</b> / Two	The number of stop bits is set here.
3173	Full-, halfduplex mode	2	<b>[Full duplex]</b>	Full duplex mode is enabled.
			Half duplex	Half duplex mode is enabled.
7908	Enable Modbus protocol	2	<b>[Yes]</b>	The Modbus protocol is enabled.
			No	The Modbus protocol is disabled.
3188	ModBus Slave ID	2	0 to 255 <b>[1]</b>	The Modbus device address, which is used to identify the device via Modbus, is entered here.  If "0" is configured here, the Modbus is disabled.
3189	Reply delay time	2	0.00 to 2.55 s <b>[0.00 s]</b>	This is the minimum delay time between a request from the Modbus master and the sent response of the slave. This time is required in half duplex mode.

### 4.6.6 Modbus Protocol

ID	Parameter	CL	Setting range [Default]	Description
3184	Modbus protocol number	2	0 to 65535	A modbus protocol may be selected by entering the data protocol ID here. If an unknown data protocol ID is configured here, nothing will be transmitted. Possible data protocol IDs are:
			5003	Data telegram
			<b>[5010]</b>	Data telegram
3179	Detect a gap in a Modbus frame	2	<b>[On]</b>	If a received modbus command has a gap between its byte of more than 5 ms, this command is ignored.
			Off	The modbus message is not checked.
3181	Power [W] exponent 10 <sup>x</sup>	2	2 to 5 <b>[3]</b>	This setting adjusts the format of the 16 bit power values in the data telegram.
			<b>Notes</b> Valid for data telegram 5010 only! Refer to <a href="#">☞ "Power measurement example" on page 371</a> for examples.	
3182	Voltage [V] exponent 10 <sup>x</sup>	2	-1 to 2 <b>[0]</b>	This setting adjusts the format of the 16 bit voltage values in the data telegram.
			<b>Notes</b> Valid for data telegram 5010 only! Refer to <a href="#">☞ "Voltage measurement example" on page 371</a> for examples.	

ID	Parameter	CL	Setting range [Default]	Description
3183	Current [A] exponent 10 <sup>x</sup>	2	-1 to 0 [0]	This setting adjusts the format of the 16 bit current values in the data telegram.
				<b>Notes</b> Valid for data telegram 5010 only! Refer to <a href="#">☞</a> "Power measurement example" on page 371 for examples.

**Power measurement example**

 Refer to parameter 3181 [☞](#) p. 370.

Power measurement:

- The measurement range is 0...250 kW
- Momentary measurement value = 198.5 kW (198.500 W)

Setting	Meaning	Calculation	Transfer value (16 Bit, max. 32767)	Possible display format
2	10 <sup>2</sup>	198500 W / 10 <sup>2</sup> W	1985	198.5 kW
3	10 <sup>3</sup>	198500 W / 10 <sup>3</sup> W	198	198 kW
4	10 <sup>4</sup>	198500 W / 10 <sup>4</sup> W	19	N/A
5	10 <sup>5</sup>	198500 W / 10 <sup>5</sup> W	1	N/A

Table 54: Power measurement example

**Voltage measurement example**

 Refer to parameter 3182 [☞](#) p. 370.

Voltage measurement:

- The measurement range is 0...480 V
- Momentary measurement value = 477.8 V

Setting	Meaning	Calculation	Transfer value (16 Bit, max. 32767)	Possible display format
-1	10 <sup>-1</sup>	477.8 V / 10 <sup>-1</sup> W	4778	477.8 V
0	10 <sup>0</sup>	477.8 V / 10 <sup>0</sup> V	477	477 V

Setting	Meaning	Calculation	Transfer value (16 Bit, max. 32767)	Possible display format
1	10 <sup>1</sup>	477.8 V / 10 <sup>1</sup> V	47	N/A
2	10 <sup>2</sup>	477.8 V / 10 <sup>2</sup> V	4	N/A

Table 55: Voltage measurement example

### Current measurement example



Refer to parameter 3183 ↗ p. 371.

Current measurement:

- The measurement range is 0...500 A
- Momentary measurement value = 345.4 A

Setting	Meaning	Calculation	Transfer value (16 Bit, max. 32767)	Possible display format
-1	10 <sup>-1</sup>	345.4 A / 10 <sup>-1</sup> A	3454	345.4 A
0	10 <sup>0</sup>	345.4 A / 10 <sup>0</sup> A	345	345 A

Table 56: Current measurement example

## 4.6.7 Modem (Active Call Function)

### General notes

The easYgen is equipped with a functionality to send ASCII strings to serial coupled modems. Through this capability the easYgen is able, depending on the modem, to actively initiate e-mails, fax and SMS messages.

### Basic functionalities

- Three independent trigger units with
  - Independent phone numbers
  - Independent messages
- Can be activated by LogicsManager
- Dial repeat when unsuccessful
- Chain phone calls (dialing another number if one call failed)

Every individual phone-unit has a couple of individual parameters. There are three text strings, when the unit is activated, which are sent out in fixed sequence.

A \0 character terminates a string, however, the \0 is not sent.

### Call units

The easYgen offers three call units to send out strings via a serial coupled modem.

This function offers a lot of possibilities, which strongly depend on the application.

**Examples**

- Call unit 1 can send an e-mail to a given mail address to inform about the current operating hours. This would be regular information.
- Call unit 2 can initiate a new upcoming alarm class with the text of the last active alarm as SMS message.
- Call unit 3 can send an SMS message later to an alternative mobile number.

**Symbolic commands and escape sequences**

Strings can hold symbolic commands. These are sub-commands in a defined format which will be replaced when sending out data. They are preceded by an `&` followed by command characters.

Escape sequences always start with a `&` character, followed by specific command strings. Some are replaced by the easYgen with dedicated replacement strings. Some others are used for flow control purposes. Unrecognized sequences will be replaced by empty strings.

Name	Command	Comment
Literal &	<code>&amp;&amp;</code>	Writes a <code>&amp;</code> .
Pause	<code>&amp;p</code>	Forces a pause of 2 seconds.
Long pause	<code>&amp;P</code>	Forces a pause of 30 seconds.
Empty buffer	<code>&amp;!</code>	Empties the receive buffer.
Limit data length	<code>&amp;lxxx;</code>	Limits the number of bytes sent out to the value <code>xxx</code> . This is to accommodate to some modem types with a limited buffer size. If for example an alarm list shall be sent with a <code>&amp;A</code> command, it's length could be larger than the modem can handle. If this command is not defined, the limit will be the default value, 700.
Serial number	<code>&amp;s</code>	Writes serial number of the device.
Item number	<code>&amp;i</code>	Writes item number and revision of the device.
Carriage return	<code>&amp;c</code>	Produces a "carriage return"-character (13).
Newline	<code>&amp;n</code>	Produces a line break consisting of CR(13) followed by a LF(10).
Control-z	<code>&amp;z</code>	Produces a <code>ctrl-z</code> -character (26). This is required as last character of a GSM message.
Check answer	<code>&amp;?xxxx;</code>	Compare the string in the receive buffer with the expected answer <code>xxxx</code> and aborts sending with a failure if they are not the same.
Last alarm	<code>&amp;e</code>	Writes last error on screen as text.
Last alarm time stamp	<code>&amp;E</code>	Writes the time stamp (date and time) of last active error.
Alarm list	<code>&amp;A</code>	Writes the content of the alarm list as a list of texts with time stamp (date and time).
Alarm list without time stamp	<code>&amp;a</code>	Writes the content of the alarm list as a list of texts.
Database description	<code>&amp;Dxxxx;</code>	Writes the description of a database value with the index "xxxx". For example the sequence " <code>&amp;D135</code> " will produce the text "Gen. Total power".
Database value	<code>&amp;vxxxx;</code>	Writes the content of a database value with the index <code>xxxx</code> . Only numeric values are displayed. For example the sequence <code>&amp;v135</code> will display the current total power as <code>xxxx.xx kw</code> .

## Configuration

Configure Interfaces > Modem (Active Call Functio...

Name	Command	Comment
Time	&t	Writes actual time.
Date	&d	Writes actual date.
GSM header	&g	Writes a GSM command <code>at+cmgs=</code> .

ID	Parameter	CL	Setting range [Default]	Description
4667	<b>Delay for call retry</b>	2	0 to 600 s [30 s]	If a call of one phone-unit was not successful, it will be repeated after the time delay configured here.
4668	<b>Max. number of call retries</b>	2	0 to 600 [30]	If a call of one phone-unit was not successful, it will be repeated the number of times configured here. If "0" is configured here, the numbers of call retries are infinite.
4660	<b>Modem initialization string</b>	2	ToolKit	<p>This string is the global basic initialization of the modem. It will be sent at the beginning of each command sequence. The input is an ASCII string, which has to be created according to the used modem type. The default setting is only a placeholder and can be configured to your modem type if needed.</p> <p><b>Notes</b></p> <p>The string can contain escape sequences.</p> <p>Please refer to ↗ <i>"Symbolic commands and escape sequences" on page 373.</i></p>
12933 12934 12935	<b>Unit{x} call requ.</b>	2	Determined by LogicsManager [(0 & 1) & 1 24.20, 24.21, 24.22]	<p>With these LogicsManager the trigger for the single unit calls can be created. This defines a condition when a phone-unit shall call.</p> <p>If the result of this equation goes to TRUE (positive edge), an internal flag "call {x} pending" [x = 1 to 3] is set and the unit will try to send a message.</p>
4661 4663 4665	<b>Modem command string (1 of 2)</b>	2	ToolKit	<p>This string is an individual initialization. It will be sent after the global initialization string. It can define certain functionalities of the modem which may be different in the different phone-units.</p> <p>The modem command string (1 of 2) can be maximum 48 characters long, but can be extended by modem command string (2 of 2).</p> <p>The total command string sent to the modem always consists of modem command string (1 of 2) and modem command string (2 of 2). A command string can consist of any ASCII character (except &amp;).</p> <p><b>Notes</b></p> <p>For special commands there are escape sequences available. They all start with &amp;.</p> <p>Please refer to ↗ <i>"Symbolic commands and escape sequences" on page 373.</i></p> <p>The start for sending this string to the modem is triggered by the Logics-Manager 12933 ↗ p. 374.</p>
4662 4664 4666	<b>Modem command string (2 of 2)</b>	2	ToolKit	This string is an extension of the modem command string described above. It will be sent immediately after this.
4669 4670 4671	<b>Reset call error</b>	2		This parameter resets a call error. After that, it will reset itself to "No".

ID	Parameter	CL	Setting range [Default]	Description
			Yes	A reset of a call error is carried out.
			[No ]	No reset is carried out

### 4.6.8 Enable External DO/AO

#### General notes

To improve the performance of HMI, Toolkit and Modbus in the easYgen, the unused external discrete outputs and external analog outputs can be disabled (In earlier easYgen releases all external DO/AO were calculated all the time independent on their use).



*If external DO/AO are connected to CAN1 bus "Enable external DO/AO" must be set to "Yes"!*

ID	Parameter	CL	Setting range [Default]	Description
13464	Enable external DO/AO	2	Yes	All external DO's and AO's are - like in earlier releases - always enabled independent on the CAN2 configuration.  The routines can be taken for producing internal flags and values.
			No	All external DO's and AO's are always disabled.
			[Auto]	The easYgen automatically checks the configuration of the CAN2 bus and enables the configured external DO's and AO's only.  Devices are selected on CAN2.

## 4.7 Configure LogicsManager

#### Logical symbols

The easYgen LogicsManager screens show logical symbols according to the IEC standard by default. However, it is also possible to change the LogicsManager screens to ASA standard.

ID	Parameter	CL	Setting range [Default]	Description
4117	Use ASA symbols	2	Yes	Symbols according to the ASA standard are used in LogicsManager screens.
			[No]	Symbols according to the IEC standard are used in LogicsManager screens.



*Refer to  Chapter 9.4.2 "Logical Symbols" on page 691 for a table of symbols according to the different standards.*

#### Internal flags

Internal flags within the LogicsManager logical outputs may be programmed and used for multiple functions.

Flag {x}	Flag 1	Flag 2	Flag 3	Flag 4	Flag 5	Flag 6	Flag 7	Flag 8
Parameter ID {yyyyy}	12230	12240	12250	12260	12270	12280	12290	12300

Table 57: Flag parameter IDs (1 to 8)

Flag {x}	Flag 9	Flag 10	Flag 11	Flag 12	Flag 13	Flag 14	Flag 15	Flag 16
Parameter ID {yyyyy}	12910	12911	12912	12913	12914	12915	12916	12917

Table 58: Flag parameter IDs (9 to 16)

ID	Parameter	CL	Setting range [Default]	Description
{yyyyy}	<b>Flag {x}</b>	2	Determined by LogicsManager [[0 & 1] & 1]	<p>The flags may be used as auxiliary flags for complex combinations by using the logical output of these flags as command variable for other logical outputs.</p> <p><b>Notes</b></p> <p>Flag 1 is also used as placeholder in other logical combinations.</p> <p>Flag 8 is preset with a timer start and shows different default values.</p>



For conditions and explanation of programming please refer to [Chapter 9.4.1 “LogicsManager Overview”](#) on page 689.

#### Timers



##### **Daily time setpoints**

Utilizing the LogicsManager it is possible to establish specific times of the day that functions (i.e. generator exerciser) can be enabled.

The two daily time setpoints are activated each day at the configured time. Using the LogicsManager these setpoints may be configured individually or combined to create a time range.





**Active time setpoint**

Utilizing the LogicsManager it is possible to establish specific days (or hours, minutes, seconds) that functions (i.e. generator exerciser) can be enabled. The active switching point is activated only on a specified day (or hour, minute, second).

The setpoints may be configured individually or combined via the LogicsManager. You may configure monthly, daily, hourly, minutely, or even secondly time setpoints depending on how you combine the setpoints in the LogicsManager.



**Weekly time setpoint**

Utilizing the LogicsManager it is possible to establish specific days of the week that functions (i.e. generator exerciser) can be enabled.

The weekly time setpoint is enabled during the indicated day from 0:00:00 hours to 23:59:59 hours.

ID	Parameter	CL	Setting range [Default]	Description
4117	Use ASA symbols	2	Yes	Symbols according to the ASA standard are used in LogicsManager screens.
			[No]	Symbols according to the IEC standard are used in LogicsManager screens.
1652 1657	Timer {x}: Hour	2	0 to 23 h 1652: [8 h] 1657: [17 h]	Enter the hour of the daily time setpoint here.  <b>Example</b> <ul style="list-style-type: none"> <li>■ 0 = 0th hour of the day (midnight).</li> <li>■ 23 = 23rd hour of the day (11pm).</li> </ul>
1651 1656	Timer {x}: Minute	2	0 to 59 min [0 min]	Enter the minute of the daily time setpoint here.  <b>Example</b> <ul style="list-style-type: none"> <li>■ 0 = 0th minute of the hour.</li> <li>■ 59 = 59th minute of the hour.</li> </ul>
1650 1655	Timer {x}: Second	2	0 to 59 s [0 s]	Enter the second of the daily time setpoint here.  <b>Example</b> <ul style="list-style-type: none"> <li>■ 0 = 0th second of the minute.</li> <li>■ 59 = 59th second of the minute.</li> </ul>
1663	Active day	2	Day 1 to 31 [1]	Enter the day of the active switch point here.  The active time setpoint is enabled during the indicated day from 0:00:00 hours to 23:59:59 hours.  <b>Example</b> <ul style="list-style-type: none"> <li>■ 01 = 1st day of the month.</li> <li>■ 31 = 31st day of the month.</li> </ul>

## Configuration

### Configure LogicsManager

ID	Parameter	CL	Setting range [Default]	Description
1662	Active hour	2	0 to 23 h [12 h]	<p>Enter the hour of the active switch point here.</p> <p>The active time setpoint is enabled every day during the indicated hour from minute 0 to minute 59.</p> <p><b>Example</b></p> <ul style="list-style-type: none"> <li>■ 0 = 0th hour of the day.</li> <li>■ 23 = 23rd hour of the day.</li> </ul>
1661	Active minute	2	0 to 59 min [0 min]	<p>Enter the minute of the active switch point here.</p> <p>The active time setpoint is enabled every hour during the indicated minute from second 0 to second 59.</p> <p><b>Example</b></p> <ul style="list-style-type: none"> <li>■ 0 = 0th minute of the hour.</li> <li>■ 59 = 59th minute of the hour.</li> </ul>
1660	Active second	2	0 to 59 s [0 s]	<p>Enter the second of the active switch point here.</p> <p>The active time setpoint is enabled every minute during the indicated second.</p> <p><b>Example</b></p> <ul style="list-style-type: none"> <li>■ 0 = 0th second of the minute.</li> <li>■ 59 = 59th second of the minute.</li> </ul>
1670	Monday active	2		Please enter the days of the weekly workdays.
			[Yes]	The switch point is enabled every Monday.
			No	The switch point is disabled every Monday.
1671	Tuesday active	2		Please enter the days of the weekly workdays.
			[Yes]	The switch point is enabled every Tuesday.
			No	The switch point is disabled every Tuesday.
1672	Wednesday active	2		Please enter the days of the weekly workdays.
			[Yes]	The switch point is enabled every Wednesday.
			No	The switch point is disabled every Wednesday.
1673	Thursday active	2		Please enter the days of the weekly workdays.
			[Yes]	The switch point is enabled every Thursday.
			No	The switch point is disabled every Thursday.
1674	Friday active	2		Please enter the days of the weekly workdays.
			[Yes]	The switch point is enabled every Friday.
			No	The switch point is disabled every Friday.
1675	Saturday active	2		Please enter the days of the weekly workdays.
			Yes	The switch point is enabled every Saturday.
			[No]	The switch point is disabled every Saturday.
1676	Sunday active	2		Please enter the days of the weekly workdays.
			Yes	The switch point is enabled every Sunday.
			[No]	The switch point is disabled every Sunday.

## 4.8 Configure Counters

### General notes

The following chapters describe all available and configurable counters of the device.

The standard/basic counters - available in all devices of this product family - are described in the chapter [Chapter 4.8.1 "General Counters" on page 379](#). For special counters please see the chapters following.

### 4.8.1 General Counters

#### General notes



#### **Maintenance call**

*A maintenance call will be issued if the configured number of maintenance hours has expired or the configured number of days has expired since the last maintenance.*

*In case of a maintenance call, the display indicates "Mainten. days exceeded" or "Mainten. hours exceeded".*

ID	Parameter	CL	Setting range [Default]	Description
2550	<b>Maintenance hours</b>	2	0 to 9,999 h [300 h]	This parameter defines the remaining hours until the next maintenance call occurs. Once the generator has been operated for the number of hours configured here, a maintenance message is displayed.  If the maintenance counter is reset either by the push-buttons at the front panel (refer to <a href="#">Chapter 5.2.1 "Front Panel" on page 393</a> ), or by configuring the parameter "Reset maintenance call" to "Yes" (parameter 2562 <a href="#">p. 379</a> ), the maintenance counter is reset to the configured value.
				<b>Notes</b> To disable the "maintenance hours" counter configure "0" for this entry.
2562	<b>Reset maintenance period hrs</b>	2	Yes / No [No]	If this parameter is configured to "Yes" the maintenance "hours" counter is reset to the configured value. Once the counter "maintenance hours" has been reset, the control unit changes this parameter to "No".
				<b>Notes</b> When using a specific code level in parameter 2567 <a href="#">p. 380</a> to reset maintenance hours this parameter can be blocked.
2551	<b>Maintenance days</b>	2	0 to 999 d [365 d]	This parameter defines the remaining days until the next maintenance call occurs. Once the configured number of days has expired since the last maintenance, a maintenance message is displayed.  If the maintenance counter is reset either by the push-buttons at the front panel (refer to <a href="#">Chapter 5.2.1 "Front Panel" on page 393</a> ), or by configuring the parameter "Reset maintenance call" to "Yes" (parameter 2563 <a href="#">p. 379</a> ), the maintenance counter is reset to the configured value.
				<b>Notes</b> To disable the "maintenance days" counter configure "0" for this entry.
2563	<b>Reset maintenance period days</b>	2	Yes / No [No]	If this parameter is configured to "Yes" the "maintenance days" counter is reset to the configured value. Once the counter has been reset, the control unit changes this parameter to "No".

## Configuration

### Configure Counters > General Counters

ID	Parameter	CL	Setting range [Default]	Description
				<p><b>Notes</b></p> <p>When using a specific code level in parameter 2567 ↪ p. 380 to reset maintenance days this parameter can be blocked.</p>
2567	<b>Code level for reset maint.</b>	2		<p>This parameter determines the required code level for resetting the counter "Maintenance call in...". User with a lower code level may not access this function.</p> <p>The following code levels exist:</p>
			0	Operator
			1	Service level
			2	Temporary commissioner
			[3]	Commissioner
				<p><b>Notes</b></p> <p>The code level defined here only affects the access via the front panel (HMI).</p>
2515	<b>Counter value preset</b>	2	0 to 999,999.99 [0]	<p>This value is utilized to set the following counters:</p> <ul style="list-style-type: none"> <li>■ operation hours counter</li> <li>■ kWh counter</li> <li>■ kvarh counter</li> </ul> <p>The number entered into this parameter is the number that will be set to the parameters listed above when they are enabled.</p>
2574	<b>Set operation hours in 0.00h</b>	0 <sup>1</sup>	Yes	The current value of this counter is overwritten with the value configured in "Counter value preset" (parameter 2515 ↪ p. 380). After the counter has been (re)set, this parameter changes back to "No" automatically.
			[No]	The value of this counter is not changed.
				<p><b>Example</b></p> <ul style="list-style-type: none"> <li>■ The counter value preset (parameter 2515 ↪ p. 380) is configured to "3456".</li> <li>■ If this parameter is set to "Yes", the "operation hour" counter will be set to 3456h.</li> </ul>
				<p><b>Notes</b></p> <p><sup>1</sup> The code level can be configured with "Codelevel set operation hours" (parameter 2573 ↪ p. 381). If your current code level does not match, this parameter is not visible.</p>
2510	<b>Gen. active power [0.00 MWh]</b>	2	Yes	The current value of this counter is overwritten with the value configured in "Counter value preset" (parameter 2515 ↪ p. 380). After the counter has been (re)set, this parameter changes back to "No" automatically.
			[No]	The value of this counter is not changed.
				<p><b>Example</b></p> <ul style="list-style-type: none"> <li>■ The counter value preset (parameter 2515 ↪ p. 380) is configured to "3456".</li> <li>■ If this parameter is set to "Yes", the "Generator active power" counter will be set to 34.56 MWh.</li> </ul>
2511	<b>Gen. react. power [0.00 Mvarh]</b>	2	Yes	The current value of this counter is overwritten with the value configured in "Counter value preset" (parameter 2515 ↪ p. 380). After the counter has been (re)set, this parameter changes back to "No" automatically.

ID	Parameter	CL	Setting range [Default]	Description
			[No]	The value of this counter is not changed.
				<b>Example</b> <ul style="list-style-type: none"> <li>■ The counter value preset (parameter 2515 ↪ p. 380) is configured to "3456".</li> <li>■ If this parameter is set to "Yes", the "Generator reactive power" counter will be set to 34.56 Mvarh.</li> </ul>
2513	<b>Gen. -react. power [0.00 Mvarh]</b>	2	Yes	The current value of this counter is overwritten with the value configured in "Counter value preset" (parameter 2515 ↪ p. 380). After the counter has been (re)set, this parameter changes back to "No" automatically.
			[No]	The value of this counter is not changed.
				<b>Example</b> <ul style="list-style-type: none"> <li>■ The counter value preset (parameter 2515 ↪ p. 380) is configured to "3456".</li> <li>■ If this parameter is set to "Yes", the "Generator -reactive power" counter will be set to 34.56 Mvarh.</li> </ul>
2541	<b>Counter value preset</b>	2	0 to 65535 [0]	This parameter defines the number of times the control unit registers a start of the generator set. The number entered here will overwrite the current displayed value after confirming with parameter 2542 ↪ p. 381.
2542	<b>Set number of starts</b>	2	Yes	The current value of the start counter is overwritten with the value configured in "Counter value present". After the counter has been (re)set, this parameter changes back to "No" automatically.
			[No]	The value of this counter is not changed.
15154	<b>Operation hours source</b>	2		This parameter configures the source for the operation hours.
			[Internal]	The operation hours are counted internal from the easYgen
			ECU/J1939	The operation hours are assumed from the connected ECU (via J1939 CAN protocol).
2573	<b>Codelevel set operation hours</b>	5	0 to 5 [3]	This parameter defines which codelevel is necessary to set the operation hours (parameter 2574 ↪ p. 380).
2509	<b>Counter value present</b>	0	0 to 999,999.99 [0]	When setting the operating hours counter (refer to parameter 2574 ↪ p. 380), the counter always will be set up to the value configured here.

## Configuration

---

Configure Counters > General Counters

## 5 Operation

The easYgen can be operated, monitored and configured using the following access methods:

- Access via the front panel (easYgen-3200 only)
  - ↳ Chapter 5.2 “Front Panel Access” on page 392
- External access with a PC (easYgen-3100/3200) using the ToolKit configuration software.
  - ↳ Chapter 5.1.1 “Install ToolKit” on page 383
- External command access using Modbus/CANopen/J1939 protocols
  - ↳ Chapter 7 “Interfaces And Protocols” on page 521

### 5.1 Access Via PC (ToolKit)

#### Version



Woodward's ToolKit software is required to access the unit via PC.

- Required version: 4.7.3 or higher
- For information on how to obtain the latest version see ↳ “Load from the website” on page 384.

#### 5.1.1 Install ToolKit

##### Load from CD

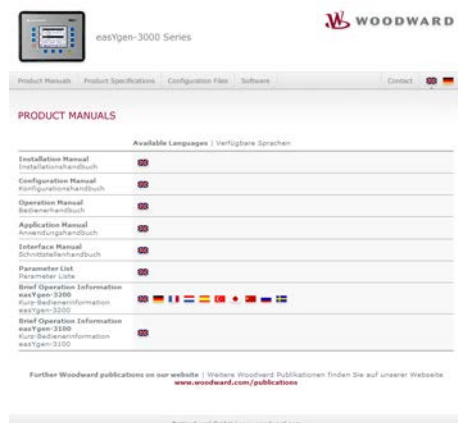

Fig. 114: Product CD - HTML menu



Fig. 115: HTML menu section 'Software'

1. ▶ Insert the product CD (as supplied with the unit) in the CD-ROM drive of your computer.
  - ⇒ The HTML menu is opened automatically in a browser.



The 'autostart' function of your operating system needs to be activated.

Alternately open the document "start.html" in the root directory of the CD in a browser.

2. ▶ Go to section “Software” and follow the instructions described there.

### Load from the website



*The latest version of the ToolKit software can be obtained from our website.*

*The latest version of Microsoft .NET Framework can be obtained from Microsoft website.*

To get the software from the website:

1. ➤ Go to <http://www.woodward.com/software>
2. ➤ Select ToolKit in the list and click the "Go" button.
3. ➤ Click "More Info" to get further information about ToolKit.
4. ➤ Choose the preferred software version and click "Download".
5. ➤ Login with your e-mail address or register first.
  - ⇒ The download will start immediately.

### Minimum system requirements

- Microsoft Windows® 8, 7, Vista SP1 or later, XP SP3 (32- & 64-bit) ; support for XP ended 2014-Apr-8.
- Microsoft .NET Framework Ver. 4.0
- 1 GHz Pentium® CPU
- 512 MB of RAM
- Screen
  - Resolution: 800 by 600 pixels
  - Colors: 256
- Serial Port
- Serial Extension Cable
- CD-ROM drive



*Microsoft .NET Framework 4.0 must be installed on your computer to be able to install ToolKit.*

- *If not already installed, Microsoft .NET Framework 4.0 will be installed automatically (internet connection required).*
- *Alternatively use the .NET Framework 4.0 installer found on the Product CD.*

### Installation

To install ToolKit:

- Run the self-extracting installation package and follow the on-screen steps to install.



## 5.1.2 Install ToolKit Configuration Files

### Load from CD

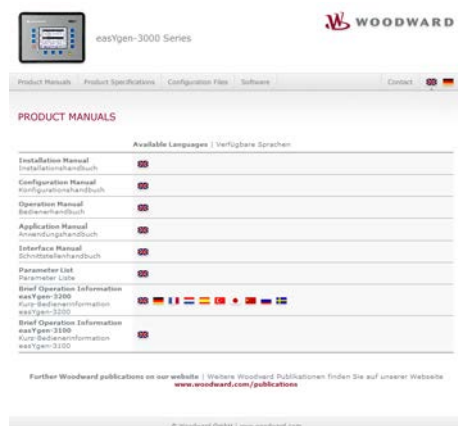

Fig. 116: Product CD - HTML menu

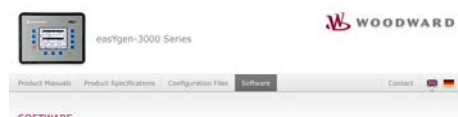

Fig. 117: HTML menu section 'Software'

### Load from the website

1. ➤ Insert the product CD (as supplied with the unit) in the CD-ROM drive of your computer.
  - ⇒ The HTML menu is opened automatically in a browser.



*The 'autostart' function of your operating system needs to be activated.*

*Alternately open the document "start.html" in the root directory of the CD in a browser.*

*Details of your current product CD menu may differ because of updates.*

2. ➤ Go to section "Configuration Files" and follow the instructions described there.



*The latest version of the ToolKit software can be obtained from our website.*

To get the software from the website:

1. ➤ Go to <http://www.woodward.com/software/configfiles>
2. ➤ Insert the part number (P/N) and revision of your device into the corresponding fields.
3. ➤ Select "ToolKit" in the "application type" list.
4. ➤ Click "Search".
5. ➤ Download the file displayed in the search result.
  - ⇒ The file is a ZIP archive which must be extracted for use in ToolKit.

## Operation

Access Via PC (ToolKit) > Install ToolKit Configura...

### ToolKit files

<b>*.WTOOL</b>	
File name composition:	[P/N1] <sup>1</sup> -[Revision]_[Language ID]_[P/N2] <sup>2</sup> -[Revision]_[# of visualized gens].WTOOL
Example file name:	8440-1234-NEW_US_5418-1234-NEW.WTOOL
File content:	Display screens and pages for online configuration, which are associated with the respective *.SID file.

<b>*.SID</b>	
File name composition:	[P/N2] <sup>2</sup> -[Revision].SID
Example file name:	5418-1234-NEW.SID
File content:	All display and configuration parameters available in ToolKit.

<b>*.WSET</b>	
File name composition:	[user defined].WSET
Example file name:	device_settings.WSET
File content:	Default settings of the ToolKit configuration parameters provided by the SID file or user-defined settings read from the unit.

- <sup>1</sup> P/N1 = Part number of the unit
- <sup>2</sup> P/N2 = Part number of the software in the unit

### 5.1.3 Configure ToolKit

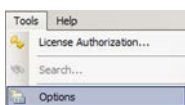

Fig. 118: Tools menu

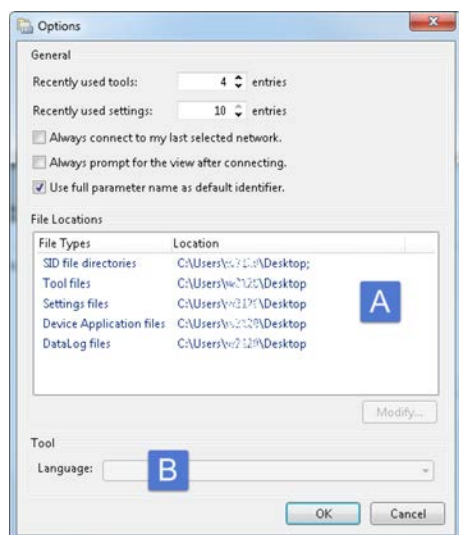

Fig. 119: ToolKit Options window

- A File locations
- B Language setting for tools

### 5.1.4 Connect ToolKit

#### Standard connection

To change ToolKit settings:

1. ➤ Select "Tools → Options".

⇒ The "Options" windows is displayed.

2. ➤ Adjust settings as required.

**i** For more information on the individual settings refer to the ToolKit online help.

⇒ Changes take effect after clicking "OK".

**i** Please do not change the default installation folder! Otherwise the language selection will not work properly.

**i** **During connecting ...**  
Don't work with event history or \*.wset files while connecting to ToolKit.

To connect ToolKit and the easYgen unit:

1. ➤ Plug the null modem cable into the RS-232 serial port of the unit and the other side to a serial COM port of the PC.

**i** If the PC does not have a serial port to connect the null modem cable to, use a USB to serial adapter.

2. ➤ Open ToolKit from the Windows Start Menu path "Programs → Woodward → ToolKit X.x".
3. ➤ From the main ToolKit window, select "File → Open Tool..." click the "Open Tool" icon  on the tool bar.
4. ➤ Locate and select the desired tool file (\*.WTOOL) in the ToolKit data file directory and click "Open".

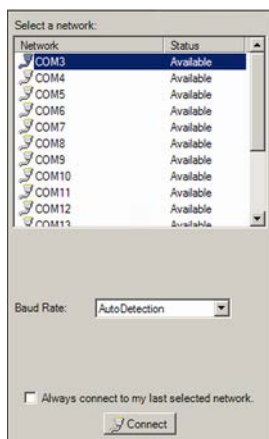

Fig. 120: Connect dialog



5. From the main ToolKit window, click Device then click “Connect”, or select the Connect icon  on the toolbar.
  - ⇒ The connect dialog will open if the option is enabled.
6. Select the COM port that is connected to the communication cable.
7. Click the “Connect” button.
  - ⇒ The identifier of the device that ToolKit is connected to, will display in the status bar.



Fig. 121: Communications window

8. If the communications window opens, select “ToolConfigurator” from the “Tool Device” list and close the communications window.
  - ⇒ If the device is security enabled, the login dialog will appear.
9. Enter the login data if required.
  - ⇒ Now you are able to edit the easYgen parameters in the main window.

 Any changes are written automatically to the control unit's memory after pressing [Enter] to confirm them..

 The RS-232 ToolKit connection can be lost if a display refresh of the easYgen-3200 is executed (ToolKit reconnects automatically).

### CAN bus connection

It is also possible to connect to the unit via CAN bus, if a suitable CAN adapter is used.

 We recommend to use the IXXAT USB-to-CAN converter which must use the VCI V3 driver.

To connect ToolKit via CAN:

1. Install the required drivers of the USB-to-CAN converter.
2. Connect the unit.
3. Open ToolKit and select a tool.
4. Select “Connect”.
5. Select the CAN connection in the “Connect” window.
6. Configure the correct baud rate and timeout in the properties dialog of the “Connect” window.



*The Password for CAN Interface 1 (parameter 10402 ↗ p. 91) must be entered before being able to edit the parameters via CAN.*

**CAN connection troubleshooting**

Fault description	Cause	Remedy
Connection error (ToolKit freezes when trying to establish a connection)	Active connections via infrared ports	Temporarily deactivate the infrared port (including virtual ports)
	Active connections via bluetooth	Temporarily deactivate bluetooth (including virtual ports)
	Additional CANopen devices connected to the bus	Contact Woodward support or provide missing .sid file for additional CANopen device (↗ "SID files for additional CAN-open devices" on page 389)

**SID files for additional CANopen devices**

When connecting a PC to the easYgen via CAN bus, other external CANopen devices (like a Phoenix Contact I/O expansion board, for example) may cause ToolKit to fail to connect.

A cause may be that ToolKit looks for a SID file for the external device, which does not exist.

A special \*.sid file can be created in this case.



*For additional support feel free to contact Woodward.*

- Create a SID (text) file with the following content:
 

```
<?xml version="1.0" encoding="utf-8"?>
<ServiceInterfaceDefinition
  xmlns:xsi="http://www.w3.org/
    2001/XMLSchema-instance"
  Identifier="[device application name]"
  Specification="EmptyFile">
</ServiceInterfaceDefinition>
```
- Name the file [CANopen device identifier].sid
- Store the file in the configured SID directory

### 5.1.5 View And Set Values In ToolKit

#### Basic navigation

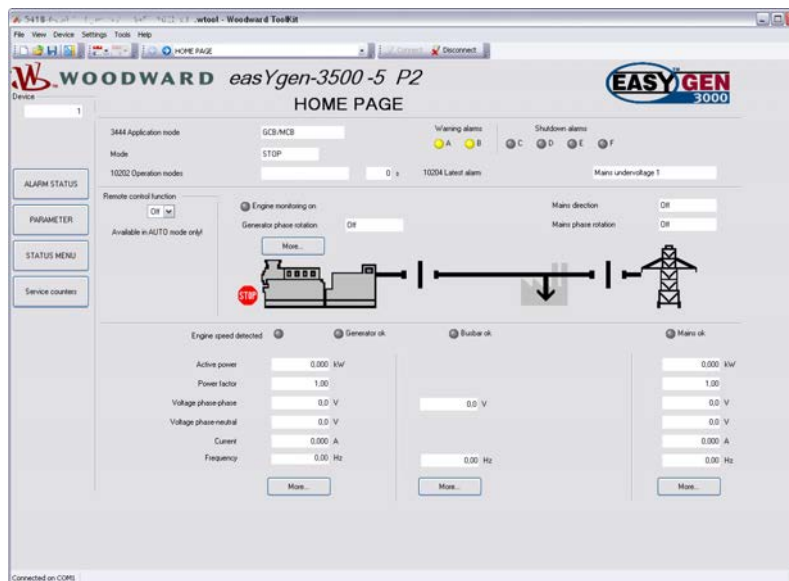

Fig. 122: ToolKit main screen

ToolKit offers the following graphical elements for basic navigation:

Graphical element	Caption	Description
	Navigation buttons	Select main and subordinate configuration pages
	Navigation list	To directly select a configuration page based on its name
	Buttons "Previous page" and "Next page"	To go to the previous/next configuration page (as ordered in the list)

#### Value and status fields

Graphical element	Caption	Description
	Value field	To directly input (alpha)numeric values
	Option field	To select from a preset list of options
	Connection status field	Displays active port and unit connection status

To change the value of a value or option field:

1. Enter the value or select an option from the drop-down list.
2. Press *[Enter]* to confirm.
  - ⇒ The new value is written directly to the unit.

### Visualization



Values displayed by visualization graphical elements cannot be changed.

Graphical element	Caption	Description
	System setup visualization	Displays engine/busbar/mains connection status
	Warning indicator	Displays status of warning alarms [on/off]
	Error indicator	Displays status of shutdown alarms [on/off]

### Remote control



This function is only available if AUTOMATIC Mode is active.

The latest order still remains active - even it is not displayed!

Graphical element	Caption	Description
	Start/Stop buttons	Select engine start or stop command
	Start command indicator	Displays status of start command [on/off]
	Stop command indicator	Displays status of stop command [on/off]

### Search

To find specific parameters, settings and monitoring values more easily, ToolKit includes a full-text search function.

To find a parameter/setting/monitoring value:

1. Select "Tools → Search" from the menu.  
⇒ The "Search" dialog opens.
2. Enter a search term and press [Enter].  
⇒ The results are displayed in the table.
3. Double-click a table entry to go to the visualization/configuration page that includes this parameter/setting/monitoring value.

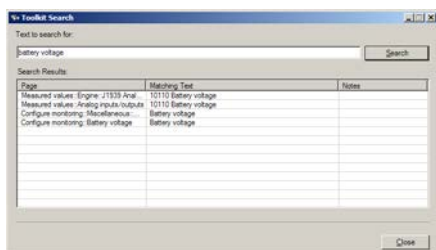

Fig. 123: Search dialog

### Value trending

The value trending view can chart up to eight values over time.

To select values for trending screen:

1. ▶ Right-click an analog value field on any configuration/visualization page and select *“Add to trend”* from the context-menu.
2. ▶ Select *“Tools → Trending”* from the menu.
  - ⇒ The trending screen opens.
3. ▶ Click the *“Start”* button to initiate charting.
4. ▶ Click the *“Stop”* button to stop charting the values.
5. ▶ To store the tracked data select *“Export”*
  - ⇒ The tracked data is exported to a .CSV (comma separated values) file which can be viewed/edited/analysed in external applications (e.g. MS Excel/OpenOffice.org Calc).

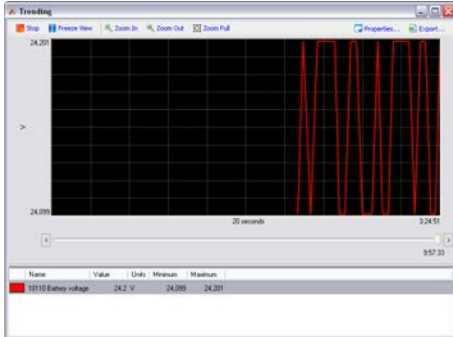

Fig. 124: Trending screen

Graphical element	Caption	Description
Start	<i>“Start”</i>	Start value charting
Stop	<i>“Stop”</i>	Stop value charting
Zoom In  Zoom Out  Zoom Full	Zoom controls	Adjust detail of value chart
Export...	<i>“Export”</i>	Export to .CSV
Properties...	<i>“Properties”</i>	Change scale limits, sample rate, time span, colors

## 5.2 Front Panel Access



*The following chapters only apply to model easYgen-3200 (with front panel and display).*



## 5.2.1 Front Panel



Fig. 125: Front panel and display

- A (1) Button Group "Display"
- B (2..4) Button Group "Mode"
- C (9..11) Button Group "Operation"
- D (5..8) Button Group "Navigation"
- 4 STOP Button
- 12 LCD Display (Screen)
- 13 LED "STOP Mode"
- 14 LED "ALARMS"

### Display

The display shows context-sensitive softkey symbols, measuring values, modes of operation, and alarms.

For information on the softkeys and menus refer to [Chapter 5.2.2 "Basic Navigation" on page 394](#) and the following chapters on specialized menu screens.

### STOP button



*The "STOP" button is always active (independent of context) and will stop the engine when pressed, except when operating modes are selected externally.*

*In this case, the AUTO and MAN Mode push buttons are also disabled.*

### Hardware buttons

The button groups provide the following functions via context-sensitive softkeys:

- "Display" - Change the method of voltage and power calculations displayed.
- "Mode" - Change the mode of operation.
- "Operation" - Used to perform manual operation of the genset and the breakers.
- "Navigation" - Navigation between system and configuration screens, and alarm list.

**LEDs**

The LEDs indicate the following states:

"STOP Mode" - The left LED indicates that the unit is in STOP mode.

"ALARMS" - The right LED indicates that alarm messages are active / present in the control unit.

**5.2.2 Basic Navigation**

**Main screen**

After power-up the control unit displays the main screen ( Fig. 126).

The main screen can be divided into the following basic sections:

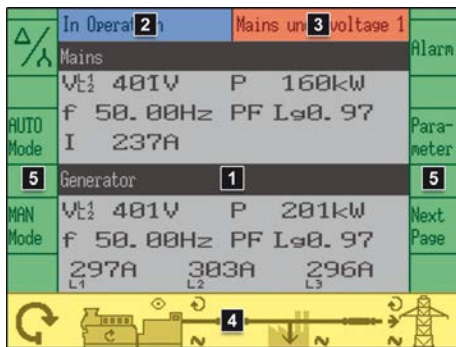

Fig. 126: Main screen

- 1 Values; marked grey, in the center of the screen
- 2 Status Messages; marked blue, upper left of the screen
- 3 Alarm Messages; marked red, upper right of the screen
- 4 Single Line Diagram; marked yellow, on the bottom of the screen
- 5 Current softkey function; marked green, on both sides of the screen

**Values**

The "values" section ( Fig. 126/1) of the screen illustrates all measured power related information including voltages, currents, frequencies, power, and power factor values.



*If the mains data display is disabled (parameter 4103 ↪ p. 94 Show mains data), the main screen will only show generator data with bigger digits.*



*The section's content changes based on the selected sub-menu screen.  
For information on specialized menu screens refer to ↪ Chapter 5.2.4 "Specialised Menu Screens" on page 401*

**Status messages**

The "status message" section ( Fig. 126/2) of the screen shows the actual operating information.



*For a list of all operation states refer to ↪ Chapter 9.5.3 "Status Messages" on page 735.*

**Alarm messages**

The "alarm message" section ( Fig. 126/3) of the screen shows the last alarm message that is occurred and not yet acknowledged.



For a list of all alarm messages refer to Chapter 9.5.4.2 "Alarm Messages" on page 739.

### Single line diagram

The single line diagram ( Fig. 126/4) shows the current status of the engine and power circuit breakers.



This section is also used for manual operation of the genset.

For additional information refer to Chapter 5.3.2 "Operating Mode MANUAL" on page 412.

















### Softkeys

The softkeys ( Fig. 126/5) permit navigation between screens, levels and functions as well as configuration and operation.

Group	Softkey	Caption	Description
Display		Display Mode	Toggle between delta/wye voltage display.
		CAN 1	Change to "CAN interface 1 state" screen.
		CAN 2	Change to "CAN interface 2 state" screen.
		Ext. I/O	Change to external discrete I/Os screen.
		Int. I/O	Change to internal discrete I/Os screen.
Mode		Reset Value Display Reset Maintenance	Reset the maximum value display. Reset the maintenance counter.
		AUTOMATIC Mode	Selects AUTOMATIC operating mode.
		MANUAL Mode	Selects MANUAL operating mode.
		STOP	Selects STOP mode (Hardware button). Pressing the STOP button for at least 10 seconds, restores the default display settings for brightness and contrast.
Operation		Increase Value	Increase selected value.
		Decrease Value	Decrease selected value.
		Confirm Input	Confirm and store changed value.
		Alarm Seen	Only displayed if the Alarm LED is flashing (indicating an alarm is present, which has not yet been acknowledged as 'Seen'). Resets the horn and acknowledges an alarm as 'Seen'.

## Operation

### Front Panel Access > Basic Navigation

Group	Softkey	Caption	Description
		Acknowledge Message	Acknowledge/Delete message/event.
		Test ON/OFF	Switch the mains decoupling "Test" ON or OFF.
		Open Breaker	Open mains/generator breaker (MANUAL mode).
		Close Breaker	Close mains/generator breaker (MANUAL mode).
		Start Generator	Start generator (MANUAL mode).
		Stop Generator	Stop generator (MANUAL mode).
		Code req.	Request a blink code for one error message from the ECU. Repeated pressing of this softkey displays all stored error messages (J1939 Special Screen). This softkey is <b>only</b> visible if the ECU is configured to "Scania S6".
		Reset	Reset the blink code (Scania S6). Reset ECU failure codes (other ECU)
Navigation		Move Up	Select previous value/entry.
		Move Down	Select next value/entry.
		Move Cursor Position	Move cursor position
		Return	Return to previous menu.
		Next Page	Go to following page/screen of the current menu.
		Parameter Screen	Show parameter screen.
		Alarm Screen	Show alarm screen.
		Help Screen	Show help screen

### Status symbols

Menu screen	Symbol	Caption	Description
Main Screen		Voltage Display Mode	The index of the symbol indicates whether delta or wye voltage is displayed and which phases are displayed.
Single Line Diagram		AUTOMATIC Mode	AUTOMATIC Mode is active.
		MANUAL Mode	MANUAL Mode is active.
		STOP Mode	STOP Mode is active.
		Rotating Field CW	Generator or mains rotating field moves clockwise.
		Rotating Field CCW	Generator or mains rotating field moves counter-clockwise.
		Power Detected	Power is detected at the respective measuring point (generator, busbar or mains).
		Monitoring Enabled	Indicates that the engine delayed monitoring has expired and the monitoring functions are enabled.
		Power Imported	Power is imported (at mains interchange).
Alarm List		Power Exported	Power is exported (at mains interchange).
		Alarm Condition Present	Indicates that corresponding alarm condition is still present.
		Alarm class A/B/C/D/E/F present	Symbol with "!" indicates that an alarm of class A/B/C/D/E/F is present.
Setpoints		Alarm class A/B/C/D/E/F not present	Symbol without "!" indicates that an alarm of class A/B/C/D/E/F is not present.
		Generator Power	Indicates the generator power (actual value).
Synchronoscope		Mains Power	Indicates the mains power (actual value).
		Phase Angle	Indicates the actual phase angle between busbar and mains or busbar and generator.
Sequencing		Breaker Closed	GCB of respective genset in sequence is closed.
		Breaker Open	GCB of respective genset in sequence is open.
Logics-Manager		Delay ON	Delay before output becomes TRUE.
		Delay OFF	Delay before output becomes FALSE.
		TRUE/enabled	Variable is TRUE (LogicsManager). The bit is enabled (CAN Interface). Relay activated (Discrete Outputs)
		FALSE/disabled	Variable is FALSE (LogicsManager). The bit is disabled (CAN Interface). Relay deactivated (Discrete Outputs)

Menu structure

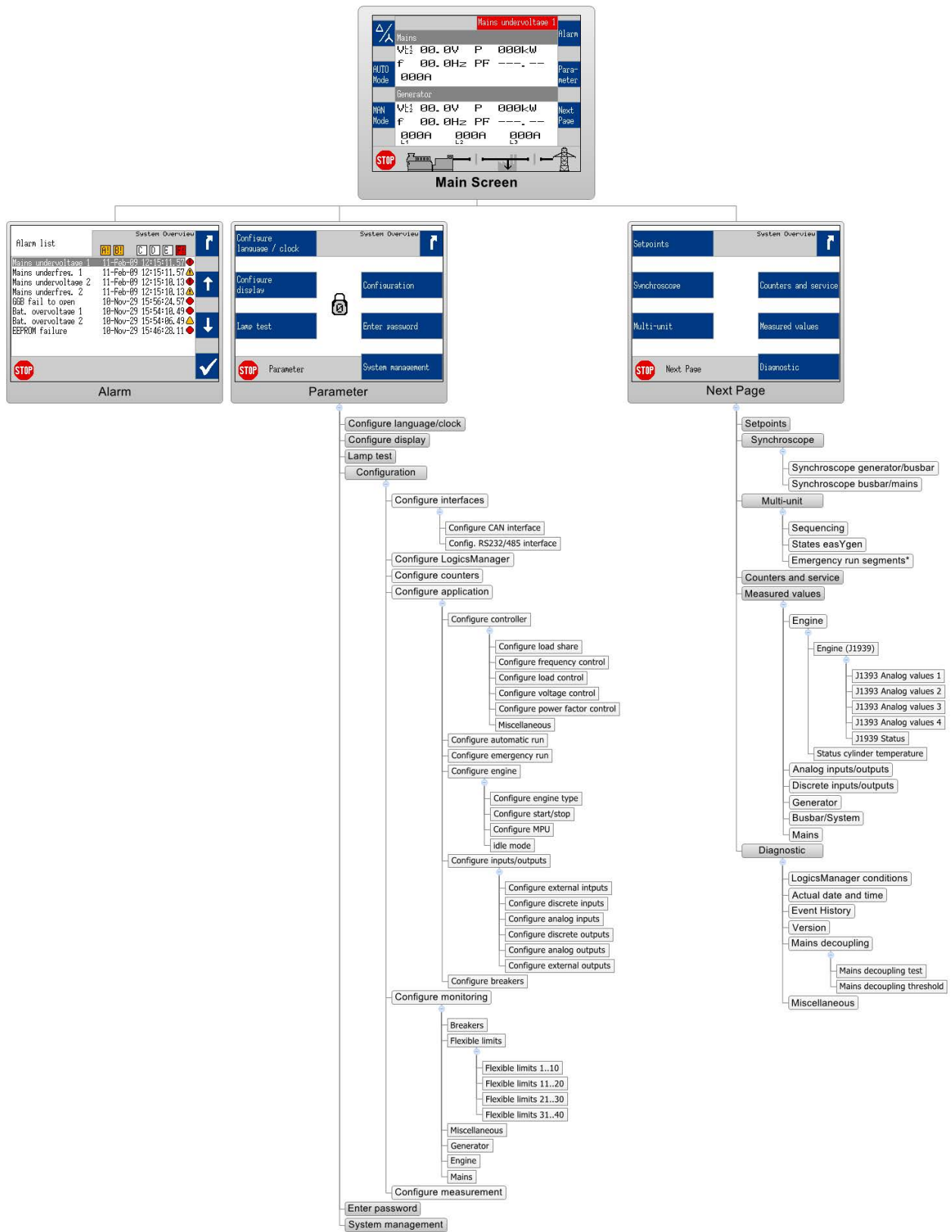

Fig. 127: Menu structure



The following chapters list notes on specific menu screens.

For information on standard softkeys and status symbols refer to [Chapter 5.2.2 “Basic Navigation”](#) on page 394.

### 5.2.3 Standard Menu Screens



The following chapters list standard menu screens, where all user input is handled similarly.

For information on standard softkeys and status symbols refer to [Chapter 5.2.2 “Basic Navigation”](#) on page 394.

For information on all other menu screens refer to [Chapter 5.2.4 “Specialised Menu Screens”](#) on page 401.

#### 5.2.3.1 Navigation Screens

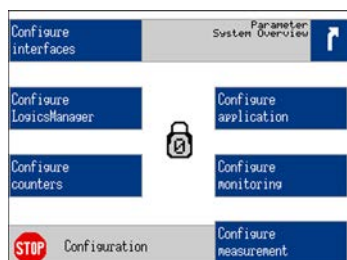

Fig. 128: Navigation screen (example)

Navigation screens offer access to sub-menu screens via the displayed softkey.

Navigation screens:

- Measured values
- Synchroscope
- Engine (J1939)
- Diagnostic
- Miscellaneous
- Parameter
- Configuration

➔ Press the desired softkey to change to a sub-menu screen.



Sub-menu entries are only displayed if the code level needed to access them is the same/or higher than the displayed code level in the center of the navigation screen.

5.2.3.2 Status/Monitoring Screens

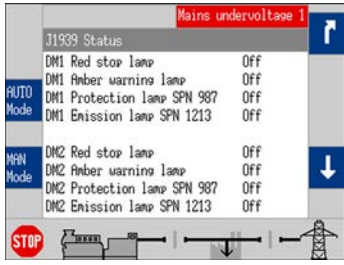

Fig. 129: Status/Monitoring screen (example)

Status/Monitoring screens display monitored values or set parameters.

Status/Monitoring screen	Notes
Analog inputs/outputs	The analog outputs are displayed as a percentage of the selected hardware range, i.e. 50 % of a 0 to 20 mA output refer to 10 mA.
Discrete inputs/outputs	The configured logic for the discrete input "N.O./N.C." will determine how the easYgen reacts to the state of the discrete input.  If the respective DI is configured to N.O., the unit reacts on the energized state, if it is configured to N.C., it reacts on the de-energized state.
Counters and service	For additional information on setting/resetting counters refer to <a href="#">Chapter 4.8 "Configure Counters" on page 379</a> .
Generator	Which values are shown in the display and whether they are correct depends on the measurement type.
Mains	Which values are shown in the display and whether they are correct depends on the measurement type.
Busbar/System	---
J1939 Status	---
Engine (J1939)	---
Analog inputs/outputs	---
Discrete inputs/outputs	---
Generator	---
Busbar	---
Mains	---
Actual date and time	---
Version	---
Load diagnostic	---

Table 59: Status/Monitoring screens



### 5.2.3.3 Value Setting Screens

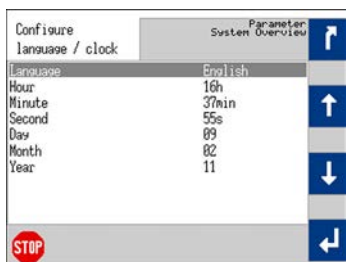

Fig. 130: Value setting screen (example)

Value setting screens:

- Configure language / clock
- Configure display
- Enter password
- System management

➔ Use the following softkeys in a value setting screen to select, change and confirm a setting.

Softkey	Description
	Select previous value/entry.
	Select next value/entry.
	Increase selected value.
	Decrease selected value.
	Confirm and store changed value.

## 5.2.4 Specialised Menu Screens

### 5.2.4.1 Main Screen Voltage Display

The voltage display softkey on the main screen changes the type of voltage display.



*The amount of information available from the system depends on how the measuring is configured in the control unit.*

The following tables illustrate what values are available depending on the configured measurement type:

	Symbol of the displayed voltage			Displayed at parameter setting			
				3Ph4W	3Ph3W	1Ph2W	1Ph3W
Press							
0× (6×)		Delta	L1-L2	Yes	Yes	Yes <sup>1</sup>	---
1×		Delta	L2-L3	Yes	Yes	---	---
2×		Delta	L3-L1	Yes	Yes	---	Yes

Press	Symbol of the displayed voltage			Displayed at parameter setting			
	$\Delta/\Delta$			3Ph4W	3Ph3W	1Ph2W	1Ph3W
3*	$V_{Ln}^1$	Wye	L1-N	Yes	---	Yes	Yes
4*	$V_{Ln}^2$	Wye	L2-N	Yes	---	---	---
5*	$V_{Ln}^3$	Wye	L3-N	Yes	---	---	Yes

Table 60: Measuring point - generator

 <sup>1</sup> Depends on setting of parameter 1858 ↪ p. 96.

Press	Symbol of the displayed voltage			Displayed at parameter setting			
	$\Delta/\Delta$			3Ph4W	3Ph3W	1Ph2W	1Ph3W
0* (6*)	$V_{L2}$	Delta	L1-L2	Yes	Yes	Yes <sup>1</sup>	---
1*	$V_{L3}$	Delta	L2-L3	Yes	Yes	---	---
2*	$V_{L1}$	Delta	L3-L1	Yes	Yes	---	Yes
3*	$V_{Ln}^1$	Wye	L1-N	Yes	---	Yes	Yes
4*	$V_{Ln}^2$	Wye	L2-N	Yes	---	---	---
5*	$V_{Ln}^3$	Wye	L3-N	Yes	---	---	Yes

Table 61: Measuring point - mains

 <sup>1</sup> Depends on setting of parameter 1858 ↪ p. 96.

5.2.4.2 Alarm List

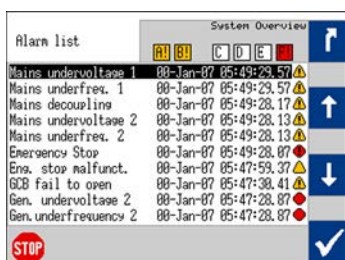



Fig. 131: Alarm List screen

All alarm messages, which have not been acknowledged and cleared, are displayed. Each alarm is displayed with the alarm message and the date and time of the alarm occurred in the format yy-mon-dd hh:mm:ss.ss.

 Self-acknowledging alarm messages get a new time-stamp when initializing the unit (switching on).

Symbol/Softkey	Description
	Indicates that corresponding alarm condition (class A/B) is still present.
	Indicates that corresponding alarm condition (class A/B) is no longer present.
	Indicates that corresponding alarm condition (class C/D/E/F) is still present.
	Indicates that corresponding alarm condition (class C/D/E/F) is no longer present.
	Symbol with "!" indicates that an alarm of class A/B/C/D/E/F is present. <ul style="list-style-type: none"> <li>■ Amber color = alarm class A/B</li> <li>■ Red color = alarm class C/D/E/F</li> </ul>
	Symbol without "!" indicates that an alarm of class A/B/C/D/E/F is not present.
	Acknowledge the selected alarm message (displayed inverted).



*Acknowledgement is only possible, if the alarm condition is no longer present. If the Alarm LED is still flashing (an alarm is present, which has not yet been acknowledged as 'Seen'), this softkey resets the horn and acknowledges the alarm as 'Seen'.*

### 5.2.4.3 Sequencing

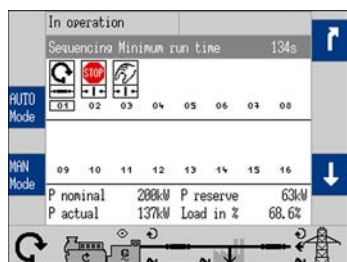

Fig. 132: Sequencing screen

The sequencing screen shows all gensets participating in load sharing. The operation mode of each genset as well as the state of its GCB is shown on this screen.

Symbol	Description
	AUTOMATIC Mode is active
	MANUAL Mode is active
	STOP Mode is active
	GCB of respective genset in sequence is closed.
	GCB of respective genset in sequence is open.
	Own easYgen device number

The remaining time is displayed on the upper right side on the grey bar "Sequencing ...", see table below:

"..." text on the grey bar	Description	Parameter / ID
Sequencing Add-on delay ... s	Shows the remaining time until the own generator is add-on	Add-on delay, 13274 ↵ p. 737
Sequencing Minimum run time ... s	Shows the remaining time until a next decision regarding LDSS is made	Minimum run time, 13276 ↵ p. 737
Sequencing Add-off delay ...s	Shows the remaining time until the own generator is add-off	Add-off delay, 13275 ↵ p. 737



The bottom field displays the actual load sharing values. If this device is not participating in load sharing, "LD start stop Off" is displayed here.

### 5.2.4.4 States easYgen

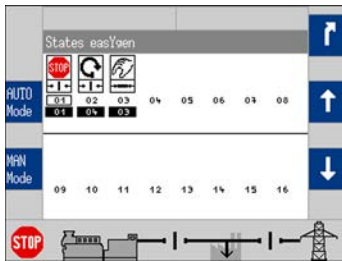

Fig. 133: States easYgen screen

The states of the easYgen devices are displayed. The operation mode of each genset as well as the state of its GCB is shown on this screen.

Symbol/Softkey	Description
	AUTOMATIC Mode is active
	MANUAL Mode is active
	STOP Mode is active
	GCB of respective genset in sequence is closed.
	GCB of respective genset in sequence is open.
	Own easYgen device number
	Other easYgen device numbers
	Segment number

### 5.2.4.5 Setpoints

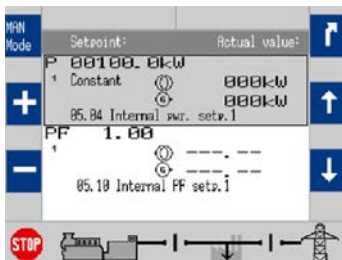

Fig. 134: Setpoints screen 1: P and PF/kvar

The setpoint is displayed on the left and the actual value is displayed on the right half of the screen.

The source, which is used for setpoint 1 or setpoint 2, is displayed with the respective LogicsManager function number.

The setpoints may only be adjusted if the respective controller is enabled. Frequency and voltage may be adjusted within the configured operating limits.

Active power may be adjusted between 0 and the configured load control setpoint maximum. The power factor may be adjusted between 0.71 leading and 0.71 lagging.



Fig. 135: Setpoints screen 2: V and f

Symbol/Softkey	Description
	Indicates the generator power (actual value).
	Indicates the mains power (actual value).
	Raise the selected setpoint.
	Lower the selected setpoint.

Manual mode and Auto mode do have separate setpoints. The Manual mode setpoints are temporary and can be set via front panel softkeys only.

Setpoint for ...	... in Auto mode	... in Manual mode
Load	5542	5529
Power factor	5641	5623
Voltage	5640	5605
Frequency	5541	5509



*ToolKit's setpoint page "STATUS MENU | Setpoints" gives an overview.*

### 5.2.4.6 PID1 - PID3

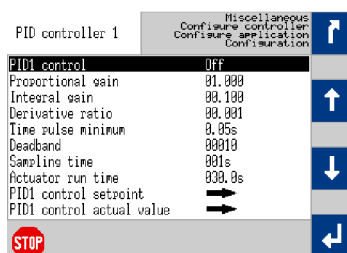

Fig. 136: PID1(-3) screen 1

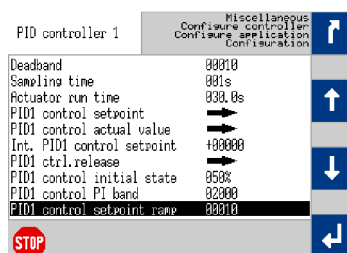

Fig. 137: PID1(-3) screen 2

Available for package 2 only.

The PID screens enable direct access to PID control settings.

5.2.4.7 Synchroscope (Generator/Busbar And Busbar/Mains)

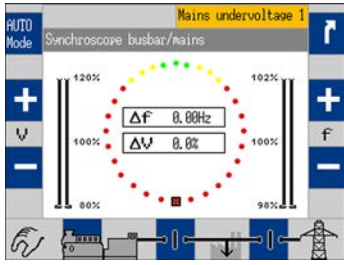

Fig. 138: Synchroscope screen (example)

The square symbol indicates the actual phase angle between busbar and generator or mains.



Please take care for compensation settings with parameters 8825 ↗ p. 229 Phase angle compensation GCB and 8824 ↗ p. 229 Phase angle GCB.

If phase angle compensation 8825 ↗ p. 229 is active the compensated values are taken for synchroscope display (and synchronization)!

The 12 o'clock position on the top means 0° and the 6 o'clock position on the bottom means 180°.

The frequency and voltage differences are indicated in the center of the circle.

Symbol/Softkey	Description
	Indicates the actual phase angle between busbar and mains or busbar and generator.
	Operating mode MANUAL: Raise voltage/frequency.
	Operating mode MANUAL: Lower voltage/frequency.

5.2.4.8 LogicsManager Conditions

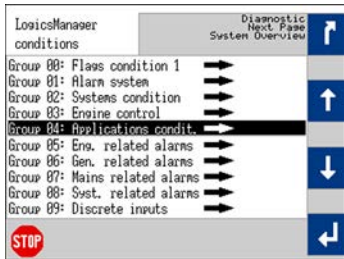

Fig. 139: LogicsManager conditions screen

This screen displays the conditions of all LogicsManager command variables, which are located in their respective groups.

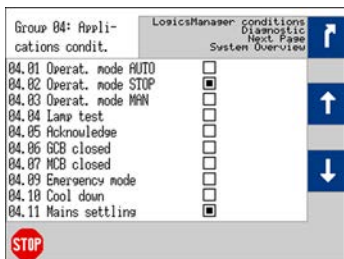

Fig. 140: Command variables screen (example)

Symbol	Description
	Select the highlighted command variable group and display the state of the command variables in this group.
<input checked="" type="checkbox"/>	Variable is TRUE.
<input type="checkbox"/>	Variable is FALSE.

### 5.2.4.9 LogicsManager

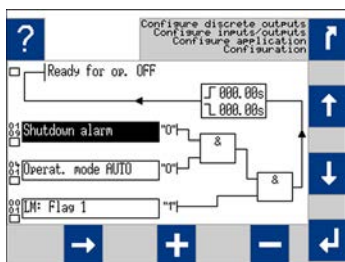

Fig. 141: LogicsManager screen

Some parameters of the easYgen are configured via the Logics-Manager.

→ Configure a logical operation using various command variables, signs, logical operators, and delay times to achieve the desired logical output.

Symbol/Softkey	Description
	Delay before output becomes TRUE.
	Delay before output becomes FALSE.
	State of the command variable is TRUE.
	State of the command variable is FALSE.
	Command variable selection field: Change the command variable group.
	Time delay configuration field: Change the cursor position.
	Show help screen (displays logical operators)

### 5.2.4.10 Event History

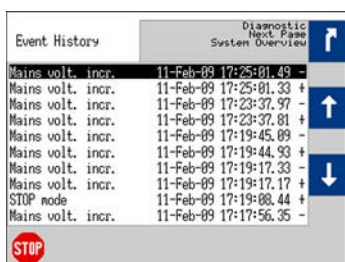

Fig. 142: Event History screen

This screen displays system events. A date/time stamp is added to each entry.

Symbol/Softkey	Description
	Indicates a condition that is still active.
	The condition is no longer present.

### 5.2.4.11 Mains Decoupling Threshold



Fig. 143: Mains decoupling screen 1

Symbol/Softkey	Description
	Starts a test mode which allows a comfortable mains decoupling configuration.
	Indicates parameters that are part of the mains decoupling configuration.

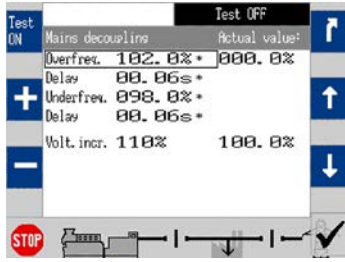

Fig. 144: Mains decoupling screen 2

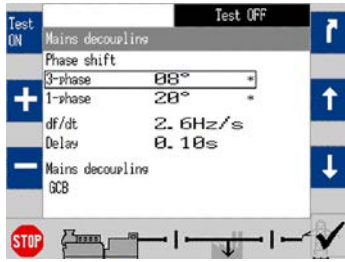

Fig. 145: Mains decoupling screen 3

5.2.4.12 Test Mains Decoupling (VDE AR-N 4105)

VDE AR-N 4105 is asking for a test button.

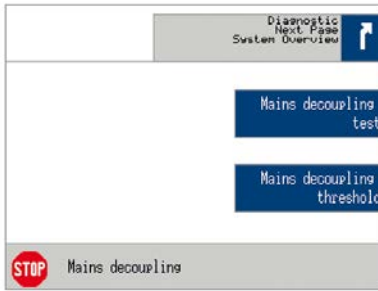

Fig. 146: Test mains decoupling selection screen

**Restricted Access**  
 The function Mains Decoupling Test is available on Code level CL3. Code levels CL0 to CL2 are intentionally not supported. Refer to Table on page 90 for details.

Mains decoupling test is running after the warning is accepted.

The Mains decoupling test opens the selected breaker for mains decoupling (parameter 3110 p. 141).



Fig. 147: Security query mains decoupling test

**This function is independent from the breaker status and is active for 1 sec.**



### 5.2.4.13 CAN Interface 1/2 State

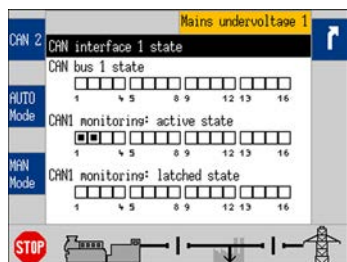

Fig. 148: CAN interface state screen (example)

Symbol		Description
<input checked="" type="checkbox"/>	TRUE/enabled	The bit is enabled.
<input type="checkbox"/>	FALSE/disabled	The bit is disabled.

Section	Bit	Assignment
Can bus 1 state	1	A TPDO has incorrect mapping parameters
	2	An RPDO has incorrect mapping parameters
	3	A TPDO has more than 8 bytes
	4	An RPDO has more than 8 bytes
	5	TIME source double
CAN 1 monitoring (active state)	{x}	RPDO {x} is not received at the moment
CAN 1 monitoring (latched state)	{x}	RPDO {x} has not been received
		<b>Notes</b> CAN 1 monitoring 3150 must be enabled
Can bus 2 state	13	One Node-ID is assigned to more than 1 device
CAN 2 monitoring (active state)	{x}	CAN Node-ID {x} is not received at the moment
CAN 2 monitoring (latched state)	{x}	CAN Node-ID {x} has not been received
		<b>Notes</b> CAN 2 monitoring 16187 must be enabled

Table 62: Bit assignments

### 5.2.4.14 Genset Bad Parameter Alignment

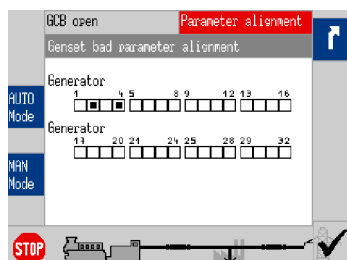

Fig. 149: Genset bad parameter alignment screen

This screen displays easYgen devices configured differently than your current device.

Symbol/Softkey	Description
<input type="checkbox"/>	The easYgens use the same configuration than your current device.
<input checked="" type="checkbox"/>	The easYgens use a different configuration than your current device.

5.2.4.15 J1939 Special

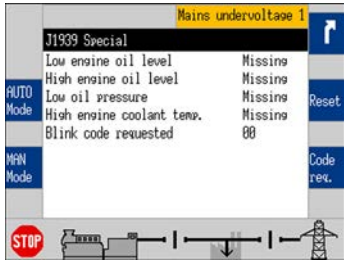

Fig. 150: J1939 Special screen (example)

The status of the configured J1939 ECU error messages is displayed here if the unit is configured accordingly. Some ECUs have a special screen for proprietary features. Fig. 150 shows the special screen for Scania S6.

*The following softkeys are only visible if parameter 15127 ↗ p. 366 is configured to "ON".*

Symbol/Softkey	Description
Code req.	Request a blink code for one error message from the ECU. Repeated pressing of this softkey displays all stored error messages. This symbol/softkey is <b>only</b> visible if the ECU is configured to "Scania S6".
Reset	<b>Scania S6:</b> Reset the blink code. To do this, disable the ignition (terminal U15), press this softkey, and enable the ignition again within 2 seconds. <b>Other ECU:</b> Reset ECU failure codes.

5.2.4.16 Time Indication According To Operating Condition

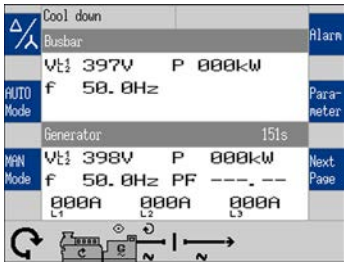

Fig. 151: Time indication according to operating condition

This screen element (on main screen) displays time indications according to the operating condition of the easYgen device. The time indications of the events indicated in the table below are shown in the display. The counter starts with the setting value of the related event and counts down to zero. After that, the status change of another event is shown. The sequence of the events is related on the configuration of the device.

Event	Description
Auxiliary services prerun	Refer to parameter 3300 ↗ p. 271 for details.
Crank protect	Refer to parameter 3326 ↗ p. 270 for details (only half of the configured time is used).
Preglow time	Refer to parameter 3308 ↗ p. 262 for details.
Starter time	Refer to parameter 3306 ↗ p. 269 for details.
Start pause time	Refer to parameter 3307 ↗ p. 270 for details.
Ignition delay	Refer to parameter 3310 ↗ p. 262 for details.
Gas valve delay	Refer to parameter 3311 ↗ p. 262 for details.
Engine monitoring delay time	Refer to parameter 3315 ↗ p. 270 for details.
Generator stable time	Refer to parameter 3415 ↗ p. 227 for details.
Cool down time	Refer to parameter 3316 ↗ p. 271 for details.

Event	Description
Stop time of engine	Refer to parameter 3326 ↪ p. 270 for details.
Auxiliary services postrun	Refer to parameter 3301 ↪ p. 272 for details.

## 5.3 Change Operating Modes

### 5.3.1 Operating Mode STOP

#### Usage



→ Use the STOP button to activate operating mode STOP.



*Observe the notes on the system's reaction upon activation of operating mode STOP as listed below.*



⇒ This symbol indicates, that operating mode STOP is selected.



*On the easYgen display the symbol is displayed in the bottom status bar next to the single line diagrams.*

#### System reaction

In operating mode STOP neither the engine nor the GCB can be operated. Dependent on the application mode the power circuit breakers cannot be operated.



#### CAUTION!

#### Hazards due to improper use of operating mode STOP

Selecting the operating mode STOP is not the same as an EMERGENCY STOP.

In some cases the easYgen will perform additional logic functions, such as an engine cool down period, before the engine is stopped.

- For emergency stop functionality use an EMERGENCY STOP discrete input, programmed as an F class alarm.

If the operating mode STOP is selected while the engine was already stopped the following applies:

- The GCB will not be closed.
- The fuel solenoid relay will not be enabled.
- The start request is ignored.
- The start push buttons (softkeys) are disabled.
- The engine/generator monitoring remains activated (exception: all monitoring that is delayed by the engine speed).

If the operating mode STOP is selected while the engine was running the following applies:

- Dependent on the current application mode a soft shut down will be executed.
- Pressing the STOP button again opens the GCB.
- If the STOP button is pressed again, the cool down will be interrupted.

If the operating mode STOP is selected while the engine performs a cool down the following applies:

- Pressing the STOP button again causes an immediate stop of the cool down and stops the engine.



*If the conditions of the LogicsManager function "Enable MCB" (parameter 12923 ↗ p. 231) are TRUE, the MCB will be closed again if it is open in STOP operating mode.*

### 5.3.2 Operating Mode MANUAL

#### General usage

In the MANUAL operating mode (softkey "MAN Mode") the engine and the power circuit breakers are operated via the push buttons along the bottom of the display (softkeys).

MAN Mode

➔ Use the softkey "MAN Mode" to activate operating mode MANUAL.



⇒ This symbol indicates, that operating mode MANUAL is selected.

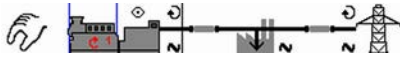

Fig. 152: Single line diagram (example)



*The single line diagram in the bottom status bar will change according to the application mode.*

*All elements that may be operated via the softkeys have (b/w display:) a black frame or (color display:) a blue background. All other elements cannot be operated.*



**NOTICE!**

The breakers will open immediately without power reduction.

To open the breaker in a no-load condition, reduce the load manually in the setpoints screen ( ↗ Chapter 5.2.4.5 "Setpoints" on page 404).

#### Example for application mode A01

When MANUAL operating mode is selected a black frame softkey character will appear around the engine to indicate that the push buttons below this softkey character may be used to start and stop the engine.

To start the engine:

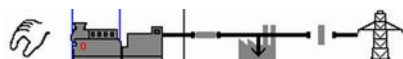

Fig. 153: Engine softkey (highlighted)

To start the engine:

- ➔ Press the button below the highlighted engine symbol.
- ⇒ Success: The engine starts and the circular arrow and the eye symbol appear.
- Failure: No change in the display until the "start failure" message appears.

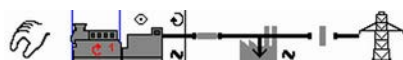

Fig. 154: Engine softkey (highlighted)

To stop the engine:

- ➔ Press the button below the highlighted engine symbol.
- ⇒ Success: The engine stops and the circular arrow and the eye symbol disappear.
- Failure: No change in the display until the "stop failure" message appears.

Overview

Function/Status	Symbol	Available in application mode			
		A01	A02	A03	A04
Start the engine		✓	✓	✓	✓
Stop the engine		✓	✓	✓	✓
Breaker open command is issued or a closure of the breaker is blocked			✓		
No defined breaker state			✓		
Open the GCB				✓	✓
Close the GCB				✓	✓
Open the MCB					✓
Close the MCB					✓

Symbol	Description
	Generator or mains rotating field moves clockwise.
	Generator or mains rotating field moves counter-clockwise.
	Power is detected at the respective measuring point (generator, busbar, or mains).
	Indicates that the engine delayed monitoring has expired and the monitoring functions are enabled.

Symbol	Description
←	Power is imported (at mains interchange).
→	Power is exported (at mains interchange).

Table 63: Status symbols

### 5.3.3 Operating Mode AUTOMATIC

#### General usage

In the AUTOMATIC operating mode, all engine, GCB, and/or MCB functions are operated via an interface, or automatically by the control unit (i.e. a mains failure).



*The function of the easYgen depends on the configuration of the unit and how the external signals are used.*

AUTO Mode

→ Use the softkey "AUTO Mode" to activate operating mode AUTOMATIC.



⇒ This symbol indicates, that operating mode AUTOMATIC is selected.



*For a more detailed description of the start/stop sequence of the engine and the associated parameters refer to ↗ Chapter 4.5.11 "Automatic Run" on page 278.*

*The main functions are briefly described in the following sections.*

#### Start engine

The engine is started via a remote start signal.

Prerequisites:

- The AUTOMATIC operating mode is enabled.
- The start request is enabled by the LogicsManager "Start req. in AUTO".
- No shut down alarm is present. (for explanation of the alarm classes refer to ↗ Chapter 9.5.1 "Alarm Classes" on page 733).
- The engine is ready for operation.
- The GCB is open.

#### Auto mains failure operation (AMF)



*Auto mains failure operation is only available in application mode **A04**.*

If the AUTOMATIC operating mode is enabled and the mains fail, the engine and the power circuit breakers will be operated according to the current application mode.

## Prerequisites:

- The AUTOMATIC operating mode is enabled.
- The parameter "Emergency power" is configured to "On".
- The configured mains failure limits are reached.
- The configured delay times have expired.
- No shut down alarm is present. (for explanation of the alarm classes refer to [Chapter 9.5.1 "Alarm Classes" on page 733](#)).
- The engine is ready for operation.

## 5.4 Restore Language Setting via HMI and Softkeys

In order to change the language setting via HMI, press the softkeys in the following order:



Fig. 155: Front panel and display

1. Press softkey [5] until you return to the starting screen (as shown in Fig. 155)
2. Press softkey [6] once to access the "Parameter" screen
3. Press softkey [1] once to access the "Configure language / clock" screen
4. Press softkey [8] once to edit the language setting
5. Press softkeys [10] or [11] to select the desired language.
6. Press softkey [8] once to commit the language setting .
  - ⇒ The desired display language is restored.

## Operation

---

Restore Language Setting via...



## 6 Application

### 6.1 Application Modes Overview

The genset control provides the following basic functions via the application modes listed below.



*For detailed information on the application modes and special applications refer to [Chapter 6 “Application”](#) on page 417.*

Application mode	Symbol	Function
None	<b>A01</b>	<p>No breaker control.</p> <p>This application mode provides the following functions:</p> <ul style="list-style-type: none"> <li>■ Measuring of engine/generator parameters (i.e. voltage, frequency, current, power, coolant temperature, oil pressure, etc.)</li> <li>■ Engine start/stop</li> </ul>
GCBopen	<b>A02</b>	<p>GCB control (open)</p> <p>This application mode provides the following functions:</p> <ul style="list-style-type: none"> <li>■ Measuring of engine/generator parameters (i.e. voltage, frequency, current, power, coolant temperature, oil pressure, etc.)</li> <li>■ Engine start/stop</li> <li>■ Engine/generator protection (relay output to open GCB)</li> <li>■ Mains failure detection with mains decoupling (GCB)</li> </ul>
GCB	<b>A03</b>	<p>GCB control (open/close)</p> <p>This application mode provides the following functions:</p> <ul style="list-style-type: none"> <li>■ Measuring of engine/generator parameters (i.e. voltage, frequency, current, power, coolant temperature, oil pressure, etc.)</li> <li>■ Engine start/stop</li> <li>■ Engine/generator protection (relay output to open GCB)</li> <li>■ GCB operation (relay output to close GCB)</li> <li>■ Mains failure detection with mains decoupling (GCB)</li> </ul>
GCB/MCB	<b>A04</b>	<p>GCB/MCB control (open/close)</p> <p>This application mode provides the following functions:</p> <ul style="list-style-type: none"> <li>■ Measuring of engine/generator parameters (i.e. voltage, frequency, current, power, coolant temperature, oil pressure, etc.)</li> <li>■ Engine start/stop</li> <li>■ Engine/generator protection (relay output to open GCB)</li> <li>■ GCB operation (relay output to close GCB)</li> <li>■ MCB operation (relay outputs to open and close MCB)</li> <li>■ Mains failure detection with mains decoupling (GCB and/or MCB)</li> <li>■ Auto mains failure operation (AMF)</li> </ul>

## 6.2 Basic Applications

### 6.2.1 Application Mode A01 (None)

This application mode (**A01**) may be used, where the breaker control is done external. In this case, the easYgen will function as an engine control with generator and engine protection. The control does not operate any breaker. Emergency mode (AMF operation) is not supported in this application mode.

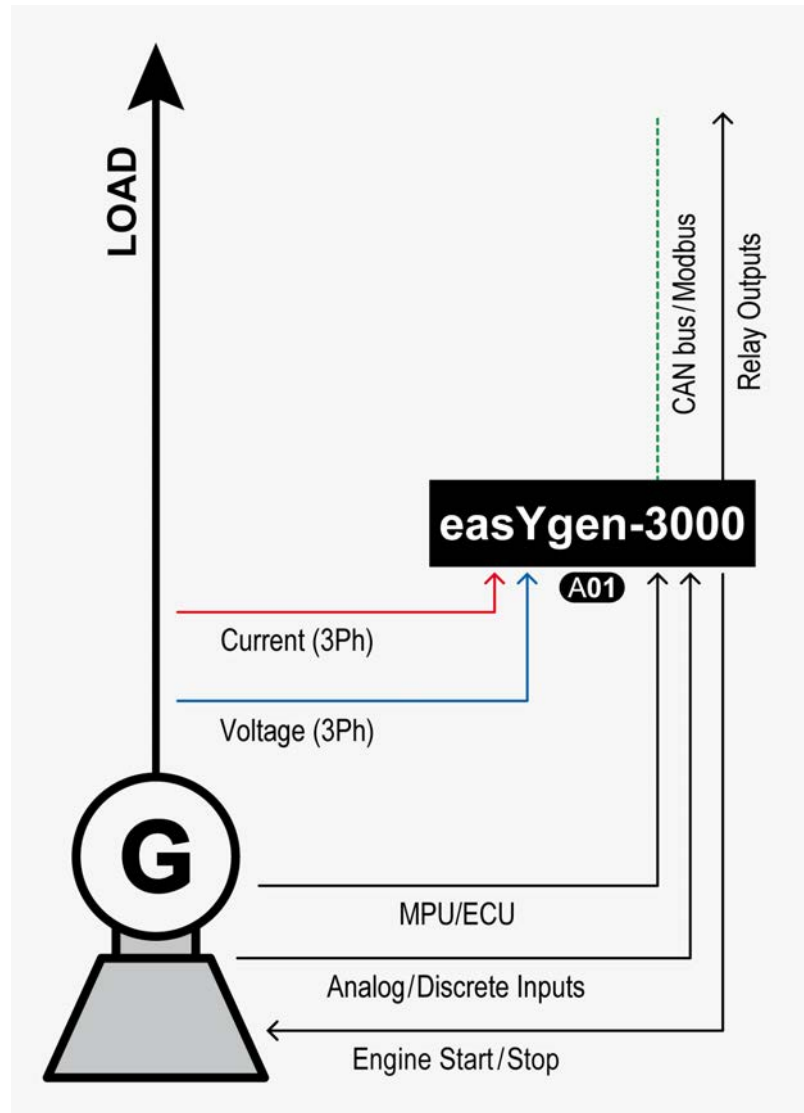

Fig. 156: Application mode A01 (schematic)



The easYgen requires the feedback reply from GCB and MCB in this application mode. These replies are used to define, whether the easYgen controls frequency, shares the load with other gensets or performs active load control.

The following feedback signals are used in this application mode and fixed to the respective discrete inputs:

- DI 7 "Reply MCB" (mains parallel)
- DI 8 "Reply GCB" (normally closed (break) contact)



*If the easYgen is intended to be operated in parallel with the mains, the mains voltage measuring inputs must be connected.*

*If an external mains decoupling is performed, jumpers between busbar and mains voltage measuring inputs may be installed.*

### Engine operation in AUTOMATIC (basic function)

#### Engine starts, if

- The LogicsManager "Start req. in AUTO" is fulfilled (TRUE) AND
- A shut down alarm is not present AND
- The engine is ready for operation

#### Engine stops, if

- The reply GCB is open AND the LogicsManager "Start req. in AUTO" is not fulfilled (FALSE) OR
- A shut down alarm occurs

Being parallel to mains or to other generator, the generator power will be reduced before.



*Refer to [Chapter 4.5.11 "Automatic Run"](#) on page 278 for details.*

## 6.2.2 Application Mode A02 (GCBopen)

This application mode (**A02**) may be used for isolated operation applications.

In this case, the easYgen will function as an engine control with generator and engine protection. The control unit can only open the GCB. Emergency mode (AMF operation) is not supported in this application mode.

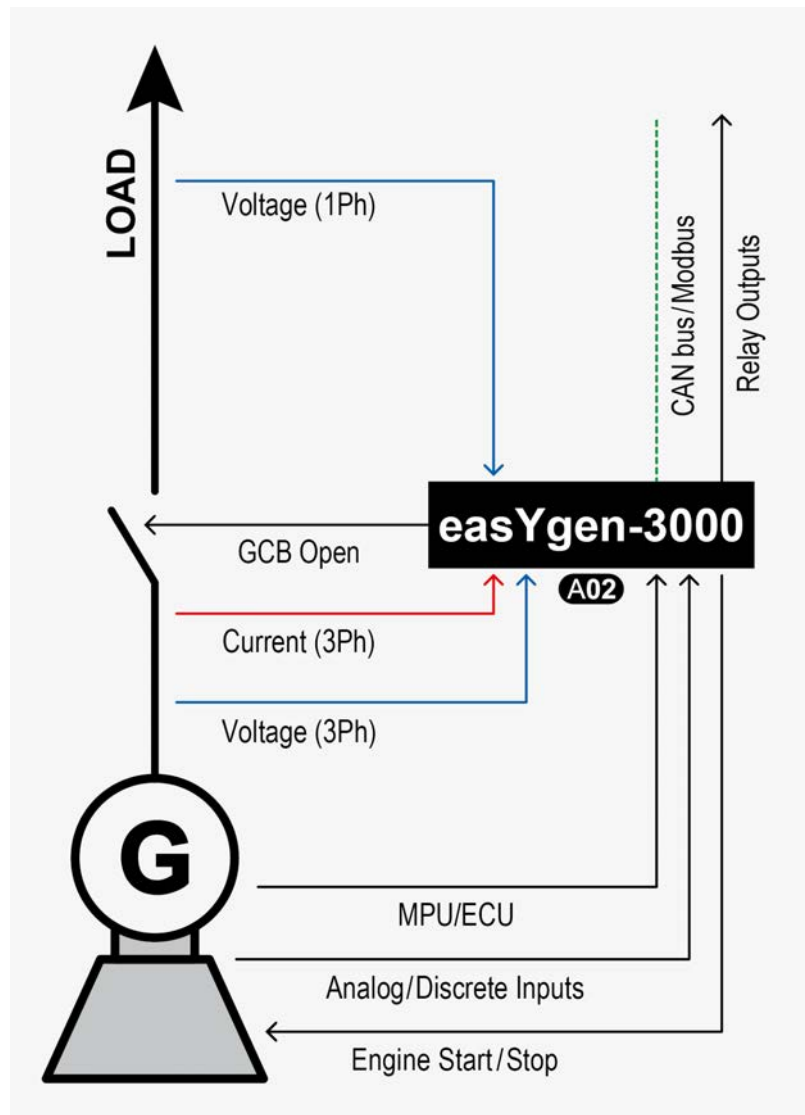

Fig. 157: Application mode A02 (schematic)



The easYgen requires the feedback reply from GCB and MCB in this application mode. These replies are used to define, whether the easYgen controls frequency, shares the load with other gensets or performs active load control.

The following feedback signals and commands are used in this application mode and fixed to the respective discrete inputs and outputs:

- DI 7 "Reply MCB" (mains parallel)
- DI 8 "Reply GCB" (normally closed (break) contact)
- DO 7 "Command: GCB open"



If the easYgen is intended to be operated in parallel with the mains, the mains voltage measuring inputs must be connected.

If an external mains decoupling is performed, jumpers between busbar and mains voltage measuring inputs may be installed.

**Engine operation in AUTOMATIC (basic function)****Engine starts, if**

- The LogicsManager "Start req. in AUTO" is fulfilled (TRUE) AND
- A shut down alarm is not present AND
- The engine is ready for operation

With successful start the GCB closure is released.

**Engine stops, if**

- The reply GCB is open AND the LogicsManager "Start req. in AUTO" is not fulfilled (FALSE) OR
- A shut down alarm occurs

Being parallel to mains or to other generator, the generator power will be reduced before.



Refer to [Chapter 4.5.11 "Automatic Run"](#) on page 278 for details.

**6.2.3 Application Mode A03 (GCB)**

This application mode (**A03**) may be used in applications, where only the GCB is operated by the easYgen.

If it is used for isolated or mains parallel operations, mains decoupling should be performed by the GCB or an external provision.

The easYgen will function as an engine control with generator and engine protection. The control unit can open and close the GCB. Emergency mode (AMF operation) is not supported in this application mode.

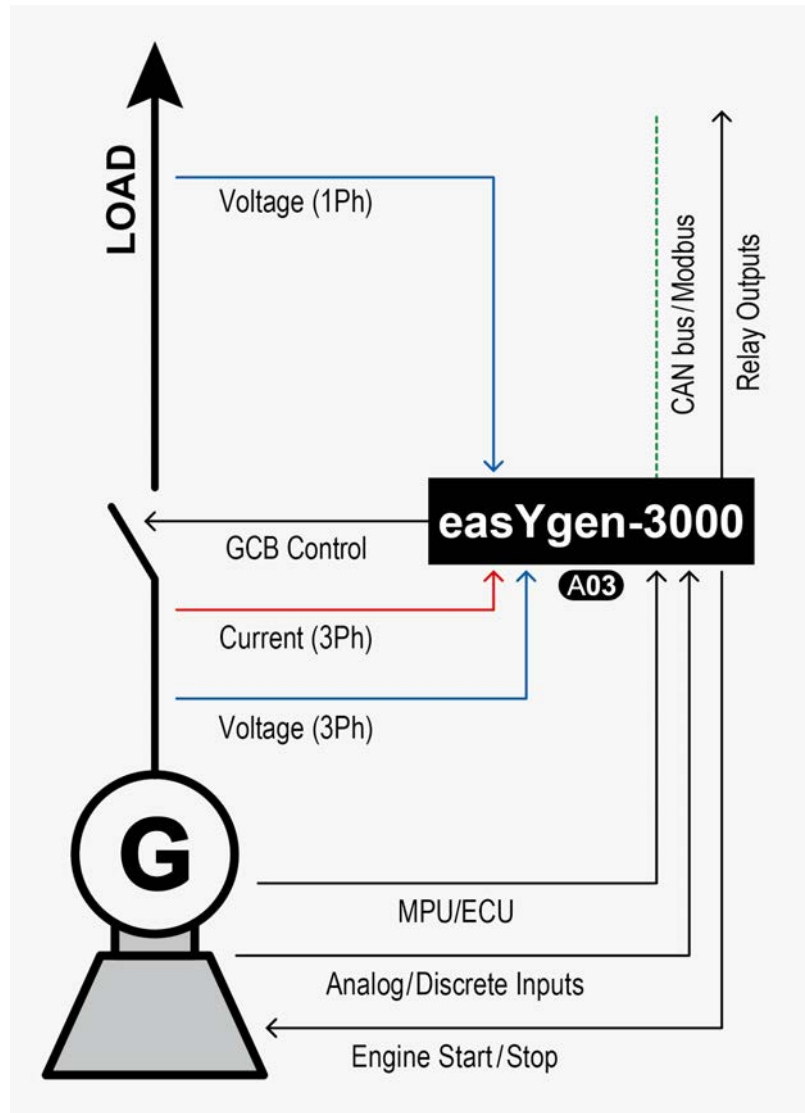

Fig. 158: Application mode A03 (schematic)



The easYgen requires the feedback reply from GCB and MCB in this application mode. These replies are used to define, whether the easYgen controls frequency, shares the load with other gensets or performs active load control.

The following feedback signals and commands are used in this application mode and fixed to the respective discrete inputs and outputs:

- DI 7 "Reply MCB" (mains parallel)
- DI 8 "Reply GCB" (normally closed (break) contact)
- DO 6 "Command: GCB close"
- DO 7 "Command: GCB open" (optionally)



*If the easYgen is intended to be operated in parallel with the mains, the mains voltage measuring inputs must be connected.*

*If an external mains decoupling is performed, jumpers between busbar and mains voltage measuring inputs may be installed.*

### Engine operation in AUTOMATIC (basic function)

#### Engine starts, if

- The LogicsManager "Start req. in AUTO" is fulfilled (TRUE) AND
- A shut down alarm is not present AND
- The engine is ready for operation

With successful start the GCB closure is executed.

- If the voltage of generator and generator busbar is in range, the GCB will be synchronized
- If the voltage of generator is in range and the **generator busbar** is dead and no other GCB is closed, the GCB will be closed

#### Engine stops, if

- The LogicsManager "Start req. in AUTO" is not fulfilled (FALSE) OR
- A shut down alarm occurs

Being parallel to mains or to other generator, the generator power will be reduced, before the GCB will be opened.



*Refer to [Chapter 4.5.11 "Automatic Run"](#) on page 278 for details.*

## 6.2.4 Application Mode A04 (GCB/MCB)

This application mode (**A04**) may be used for mains parallel operation. In this case, the easYgen will function as an engine control with generator, mains and engine protection.

The control unit can open and close the GCB and the MCB. The breaker transition modes "Open Transition", "Closed Transition", "Interchange" and "Parallel" are possible.

The Emergency mode (AMF operation) is supported in this application mode.

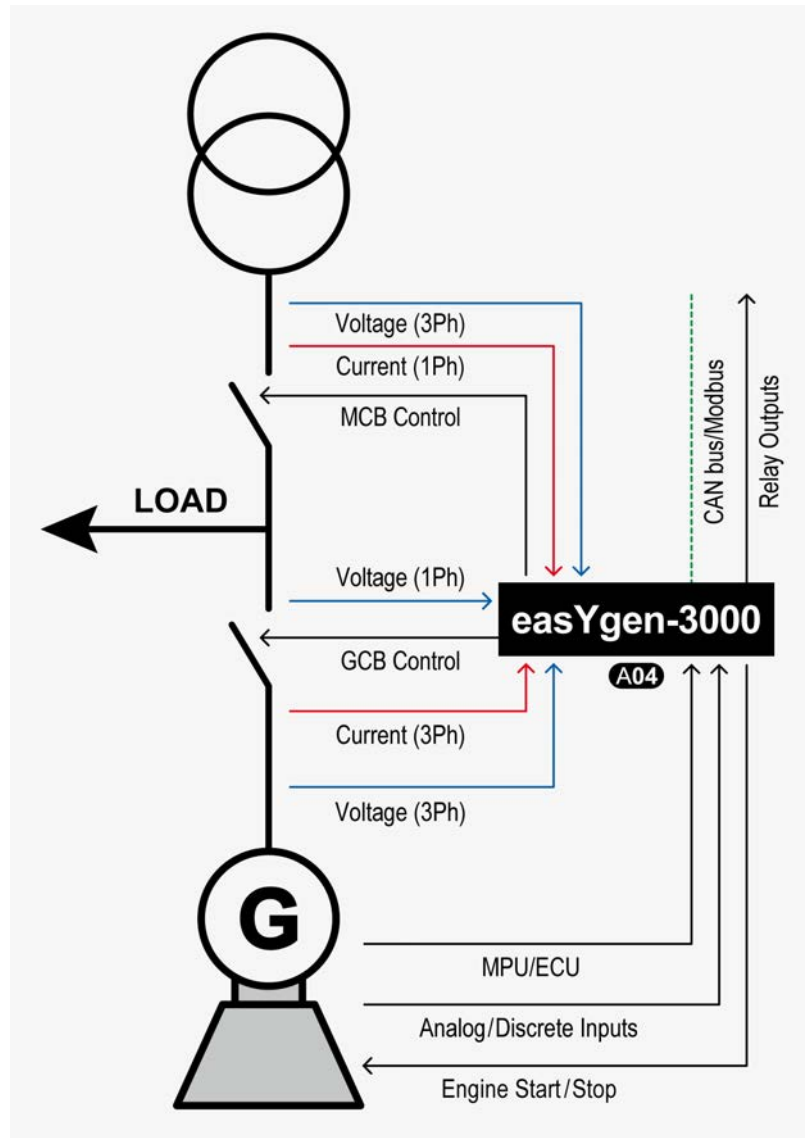

Fig. 159: Application mode A04 (schematic)



The easYgen requires the feedback reply from both circuit breakers in this application mode. These replies are used to define, whether the easYgen controls frequency, shares the load with other gensets or performs active load control.

The following feedback signals and commands are used in this application mode and fixed to the respective discrete inputs and outputs:

- DI 7 "Reply MCB" (mains parallel)
- DI 8 "Reply GCB" (normally closed (break) contact)
- DO 6 "Command: GCB close"
- DO 7 "Command: GCB open" (optionally)
- DO 8 "Command: MCB close"
- DO 9 "Command: MCB open"

Engine operation in AUTOMATIC (basic function)

Engine starts, if



- The LogicsManager "Start req. in AUTO" is fulfilled (TRUE) AND
- A shut down alarm is not present AND
- The engine is ready for operation

According to the current active breaker transition mode the GCB and MCB will be operated.

#### Engine stops, if

- The LogicsManager "Start req. in AUTO" is not fulfilled (FALSE) OR
- A shut down alarm occurs

According to the current active breaker transition mode the GCB and MCB will be operated.



Refer to [Chapter 4.5.11 "Automatic Run"](#) on page 278 for details.

#### Auto mains failure operation (AMF) in AUTOMATIC (basic function)

#### Engine starts, if

- The configured mains failure limits are reached AND
- A shut down alarm is not present AND
- The engine is ready for operation

With successful start the MCB will be opened and the GCB will be closed.

#### Engine stops, if

- The mains values are back in range AND
- The mains settling time is expired

According to the current active breaker transition mode the GCB and MCB will be operated.

## 6.3 Multiple Genset Applications

### Overview

In a multiple-unit mains parallel application, all easYgens need the same signals for:

- Mains voltage and current
- Reply and release signal of the MCB



*The open and close contacts from all controls must be wired in parallel.*

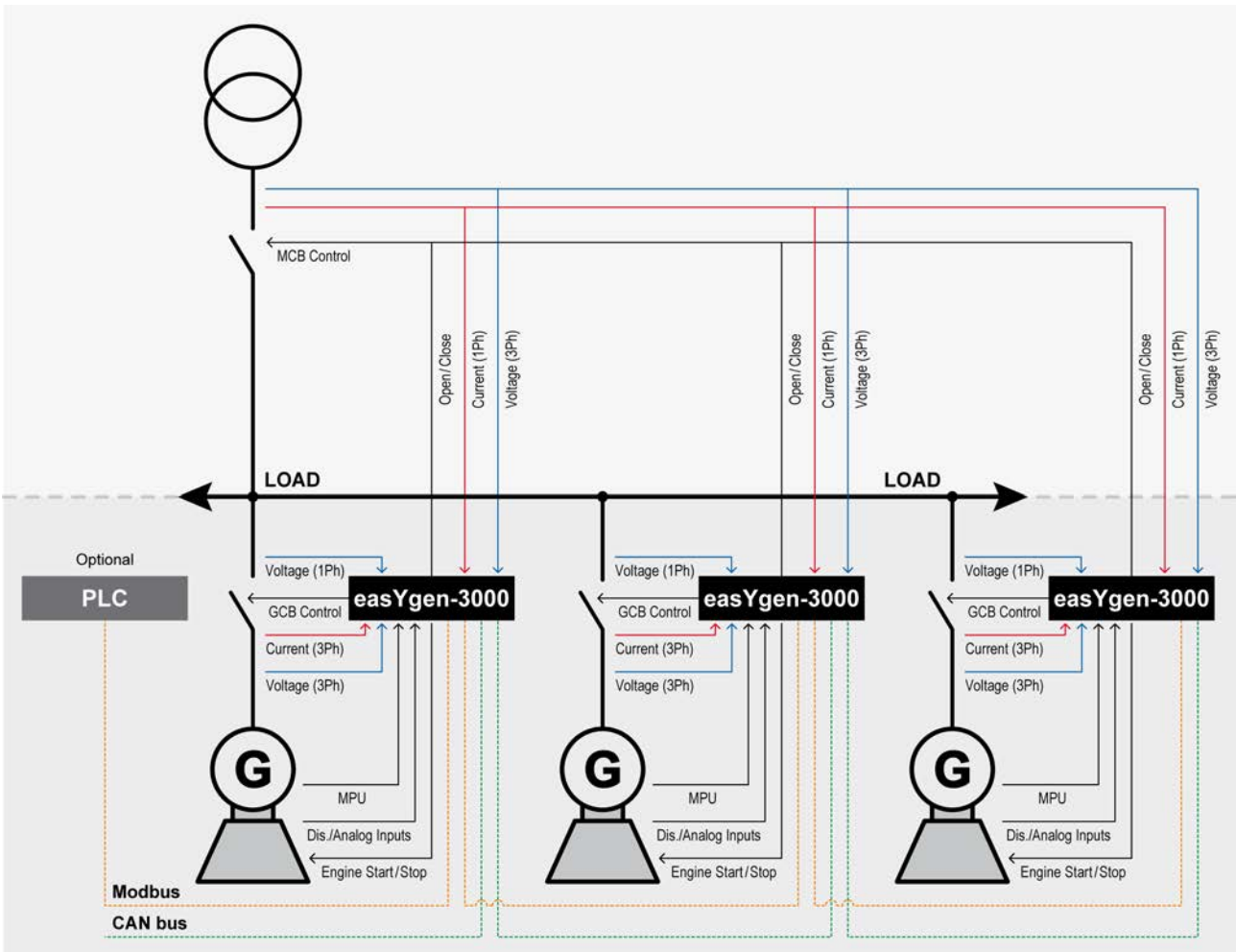

Fig. 160: Multiple genset application (schematic)

### Configuration example

The following example describes the configuration of a typical mains parallel operation with import/export power control at the interchange point and load-dependent start/stop.

Multiple generators are to be operated in parallel to the mains maintaining a stable power at the interchange point. The generators shall be started depending on the momentary load at the plant. An emergency operation in case of a mains failure is also intended.

The load dependent start/stop function (LDSS) shall be enabled with a remote start request. LDSS shall depend on the reserve power on the busbar. In case of a dead busbar (caused by a mains failure) all capable generators shall be started and operated with their minimum running time.

No generator priority is considered. Generator selection shall be performed depending on the operating hours.

The following assumptions are valid for the example:

- 3 generators, each with 80 kW rated power, are available.
- The recommended minimum load for the generators is 40 kW.
- The minimum running time is 180 s.

### 6.3.1 Configuring Load-Dependent Start/Stop

1. ➤ Either on the front panel or using ToolKit navigate to menu "Load dependent start/stop".
2. ➤ Configure the parameters below.

ID	Parameter	Value	Comment
5752	Start stop mode	Reserve power	The reserve power at the interchange point is to be considered for LDSS
5753	Dead busbar start mode	All	All generators shall start in case of a dead busbar (mains failure)
5751	Base priority	5	The base priority for the genset is 5
5754	Fit size of engine	No	The generator rated power is not considered for LDSS
5755	Fit service hours	Equal	The remaining hours until next service are considered for LDSS
5756	Changes of engines	Off	No engine change will be performed
5759	Minimum running time	180 s	The minimum running time is 180 seconds

Table 64: Parameter configuration for LDSS

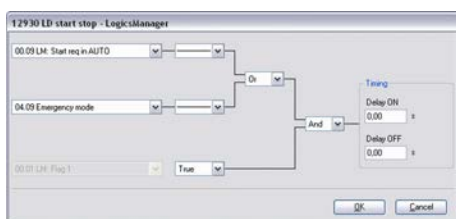

Fig. 161: LogicsManager function "LD start stop"

3. ➤ Configure the LogicsManager function "LD start stop" as shown in ( Fig. 161) to enable LDSS if a start request in automatic operating mode or emergency mode are enabled.

#### LDSS for isolated operation

Additional assumptions are valid for isolated operation (IOP), i.e. in case of an emergency operation:

- A reserve power of 80 kW on the busbar shall be maintained, i.e. at least 2 generators are available in isolated operation for redundancy because no supporting mains are present.
- A hysteresis of 20 kW is required to avoid frequent starts and stops.
- The delay for adding another generator shall be 10 seconds.
- The delay for adding another generator shall be reduced to 3 seconds if a generator at the busbar is operating above its rated load (accelerated start of the next generator).
- The delay for removing a generator from the busbar shall be 180 seconds.

1. ➤ Either on the front panel or using ToolKit navigate to menu “Load dependent start/stop ➔ Isolated operation”.
2. ➤ Configure the parameters listed below.

ID	Parameter	Value	Comment
5760	IOP Reserve power	80 kW	The reserve power in isolated operation is 80 kW
5761	IOP Hysteresis	20 kW	The reserve power hysteresis in isolated operation is 20 kW
5764	IOP Add on delay	10 s	The add on delay in isolated operation is 10 seconds
5765	IOP Add on delay at rated load	3 s	The add on delay at rated load in isolated operation is 3 seconds
5766	IOP Add off delay	180 s	The add off delay in isolated operation is 180 seconds

Table 65: Parameter configuration for LDSS (IOP)

**LDSS for mains parallel operation**

Additional assumptions are valid for mains parallel operation (MOP):

- The first generator is only started if it is able to operate at a minimum load of 40 kW.
- A hysteresis of 20 kW is required to avoid frequent starts and stops.
- A reserve power of 10 kW on the busbar shall be maintained, i.e. at least 10 kW of generator capacity are available for short load peaks.  
Higher load peaks are supported by the mains.
- The delay for adding another generator shall be 30 seconds.
- The delay for adding another generator shall be reduced to 10 seconds if a generator at the busbar is operating above its rated load (accelerated start of the next generator).
- The delay for removing a generator from the busbar shall be 60 seconds.

1. ➤ Either on the front panel or using ToolKit navigate to menu "Load dependent start/stop ➔ Mains parallel operation".
2. ➤ Configure the parameters listed below.

ID	Parameter	Value	Comment
5767	MOP Minimum load	40 kW	The minimum load in mains parallel operation is 40 kW
5769	MOP Hysteresis	20 kW	The reserve power hysteresis in mains parallel operation is 20 kW
5768	MOP Reserve power	10 kW	The reserve power in mains parallel operation is 10 kW
5772	MOP Add on delay	30 s	The add on delay in mains parallel operation is 20 seconds
5773	MOP Add on delay at rated load	10 s	The add on delay at rated load in mains parallel operation is 10 seconds
5774	MOP Add off delay	60 s	The add off delay in mains parallel operation is 60 seconds

Table 66: Parameter configuration for LDSS (MOP)

### 6.3.2 Configuring Automatic Operation

1. ➤ Either on the front panel or using ToolKit navigate to menu "Configure automatic run".
2. ➤ Configure the LogicsManager function "Start req in AUTO" as shown in ( Fig. 162) to start the generator in Automatic operating mode if discrete input [DI 02] ("09.02 Discrete input 2") is energized or a remote start request ("04.13 Remote request" = start via interface) is issued.

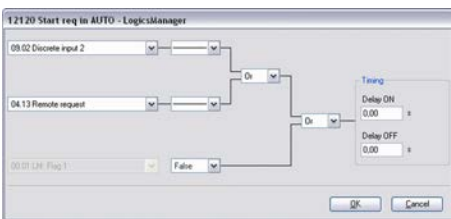

Fig. 162: LogicsManager function "Start req in AUTO"

### 6.3.3 Configuring Emergency Operation

Configure emergency operation to be initiated if the mains fails for at least 3 seconds or the MCB cannot be closed.



1. ➤ Either on the front panel or using ToolKit navigate to menu "Configure emergency run".
2. ➤ Configure the parameters listed below.

ID	Parameter	Value	Comment
2802	On/Off	On	Emergency operation is enabled
2800	Mains fail delay time	3.00 s	Emergency operation is initiated if the mains fail for a t least 3 seconds
3408	Emerg. start with MCB failure	Yes	Emergency operation is initiated if the MCB fails to close

Table 67: Parameter configuration for emergency run

### 6.3.4 Configuring Power Control

Configure the power controller to use the internal power setpoint 1, which must be set to 0 kW import power.

1.  Either on the front panel or using ToolKit navigate to menu "Configure load control".
2.  Configure the parameters listed below .

ID	Parameter	Value	Comment
5539	Load setpoint 1 source	05.04. Internal pwr. setp.1	The internal power setpoint 1 is used as load setpoint 1
5526	Load setpoint 1	Import	The internal power setpoint 1 is a import power value
5520	Int. load control setpoint 1	0 kW	The internal power setpoint 1 is configured to 0 kW

Table 68: Parameter configuration for import/export power control

## 6.4 Special Applications

### 6.4.1 Generator Excitation Protection

The easYgen controller provides the user with power factor monitoring. These monitoring functions permit for protection of the generator over- and under-excitation. The power factor monitoring consists of a warning alarm and/or a shutdown alarm when enabled.

An alarm and the specified action will be initiated if the monitored power factor surpasses the defined limits. Typically the generator is monitored for loss of excitation and/or over excitation in a mains parallel application.

When a generator plant is paralleled against a utility, it is possible to control the power factor at a desired reference. When the plant is operated in an island mode or isolated parallel application, it is not possible to control the power factor. The load will dictate what the power factor is due to the reactive nature of the load.

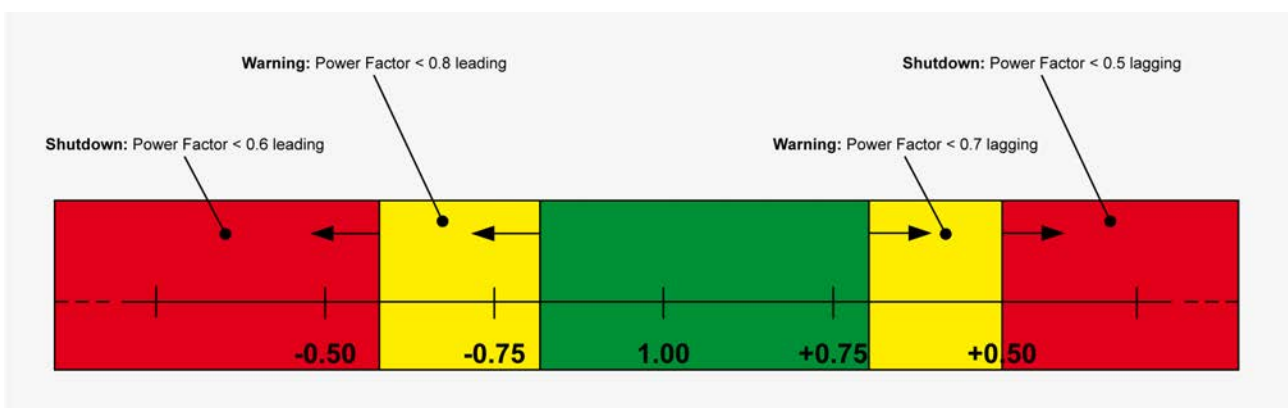

Fig. 163: Example - generator excitation protection

Fig. 163 shows a typical power factor (generator excitation) protection range, where the desired range of operation (green area) is from 0.7 lagging (inductive) to 0.8 leading (capacitive).

When the power factor exceeds either of these limits by entering the yellow shaded areas starting at 0.7 lagging or 0.8 leading for more than 30 seconds, a class B warning alarm is initiated.

If the power factor exceeds the desired range further and enters the red shaded areas starting at 0.5 lagging or 0.6 leading for 1 second, a class E alarm is initiated and the generator is shut down.

## Configuration

➔ In order to achieve the described protection, the power factor monitoring parameters ( [Chapter 4.4.1.15 “Generator Lagging Power Factor \(Level 1 & 2\)”](#) on page 134 or [Chapter 4.4.1.16 “Generator Leading Power Factor \(Level 1 & 2\)”](#) on page 136) have to be configured as shown below.

Generator power factor lagging level 1			Generator power factor lagging level 2		
ID	Text	Setting	ID	Text	Setting
2325	Monitoring	On	2331	Monitoring	On
2329	Limit	+0.700	2335	Limit	+0.500
2330	Delay	30.00 s	2336	Delay	1.00 s
2326	Alarm class	B	2332	Alarm class	E
2327	Self acknowledge	No	2333	Self acknowledge	No
2328	Delayed by engine speed	Yes	2334	Delayed by engine speed	Yes

Generator power factor leading level 1			Generator power factor leading level 2		
ID	Text	Setting	ID	Text	Setting
2375	Monitoring	On	2381	Monitoring	On
2379	Limit	-0.800	2385	Limit	-0.600
2380	Delay	30.00 s	2386	Delay	1.00 s
2376	Alarm class	B	2382	Alarm class	E
2377	Self acknowledge	No	2383	Self acknowledge	No
2378	Delayed by engine speed	Yes	2384	Delayed by engine speed	Yes

## 6.4.2 Configuring A Setpoint Control Via Analog Input

The following example illustrates how to configure an easYgen to use an external load setpoint via analog input [AI 03].

The external setpoint may be enabled using a switch, wired to discrete input [DI 09].

An analog 0 to 20 mA input is to be used where 4 mA corresponds with 0 % power (0 MW), 12 mA corresponds with 50 % power (1 MW), and 20 mA corresponds with 100 % power (2 MW).

**Configuring the rated generator power**

1. ▶ Either on the front panel or using ToolKit navigate to menu “Configure measurement”.
2. ▶ Configure the parameter listed in ↗ “Parameters for rated generator power” on page 432.

ID	Parameter	Value	Comment
1752	Gen. rated active power [kW]	2000	Generator rated power of 2 MW

Table 69: Parameters for rated generator power

**Configuring the analog input for real power setpoint**

1. ▶ Either on the front panel or using ToolKit navigate to menu “Configure analog inputs → Analog input 3”.
2. ▶ Configure the parameters listed below.

ID	Parameter	Value	Comment
1100	Type	Linear	A user-defined linear characteristic curve is to be used
1101	User defined min display value	+00000	A value of 000.00 % is displayed at the minimum of the input range
1102	User defined max display value	+10000	A value of 100.00 % is displayed at the maximum of the input range
1139	Sender value at display min.	020.00 %	The sender value at minimum display is 20 % i.e. 4 mA
1140	Sender value at display max.	100.00 %	The sender value at maximum display is 100 % i.e. 20 mA
1120	Sender type	0 - 20 mA	A 0 to 20 mA sender is used on the analog input
1103	Monitoring wire break	Low	If the analog signal falls below 2 mA, a wire break is indicated
1104	Wire break alarm class	Class B	An alarm of class B will be issued in case of a wire break
1105	Self acknowledge wire break	No	A wire break is not automatically cleared after it has been repaired
10116	Filter time constant	Off	No filter time constant is applied to the analog signal
3636	Bargraph minimum	+00000	The start value for the bargraph display of the analog input is 00000
3637	Bargraph maximum	+10000	The end value for the bargraph display of the analog input is 10000



3. Configure the following parameters using ToolKit. They facilitate a more detailed display of the analog value.

ID	Parameter	Value	Comment
1125	Description	ActivePower SP (%)	Analog input [AI 03] is labeled with "ActivePower SP (%)" on the display
1135	Value format	000.00 %	The value format of the bargraph display of the analog input is "000.00 %"

### Configuring the load controller

The load controller is to be configured that it uses a fixed load setpoint 1 of 2 MW unless a switch energizes discrete input [DI 04] for enabling a variable load setpoint 2, which is controlled by analog input [AI 03].

1. Either on the front panel or using ToolKit navigate to menu "Configure load control".
2. Configure the parameters listed below.

ID	Parameter	Value	Comment
5539	Load setpoint 1 source	05.04 Internal pwr. setp.1	Internal power setpoint 1 is used as setpoint 1
5526	Load setpoint 1	Constant	A constant load is to be controlled for setpoint 1
5520	Int. load control setpoint 1	02000.0 kW	A constant load of 2 MW is to be used for internal setpoint 1
5540	Load setpoint 2 source	06.03 Analog input 3	Analog input 3 is used as setpoint 2
5527	Load setpoint 2	Constant	A constant load is to be controlled for setpoint 2

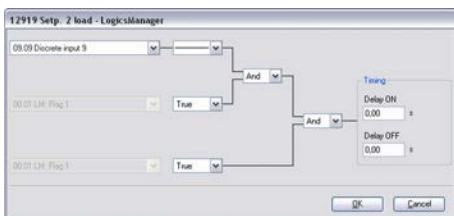

Fig. 164: LogicsManager function "Setp. 2 load"

3. Configure the LogicsManager function "Setp. 2 load" as shown in ( Fig. 164) to enable load setpoint 2 if discrete input [DI 09] is energized.

### Viewing the load setpoint on the easYgen

Mode	In operation	Setpoint:	Actual value:
P	00100.0kW	098kW	098kW
1	Constant	05.04 Internal pwr. setp.1	
PF	09.98	1.00	
1	05.10 Internal PF setp.1		
V	000400V	398V	
1	05.07 Internal volt. setp.1		
F	50.00Hz	50.00Hz	
1	05.01 Internal freq. setp.1		

Fig. 165: Screen "Setpoint"

1. After the unit is configured as described above, the "Setpoint" screen may be viewed from the main screen by selecting "Next page → Setpoints".

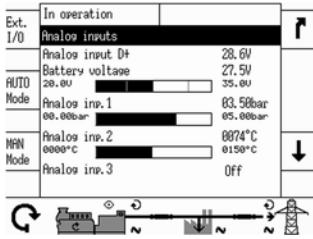

Fig. 166: Screen "Analog inputs"

2. The "Analog inputs" screen may be viewed from the main screen by selecting "Next page → Measured values → Analog inputs/outputs".

### 6.4.3 Creating Self-Toggling (Pulsing) Relays



This function is set up with the LogicsManager.

This is a simple example of a relay output that toggles from energized to de-energized in automatic mode with adjustable on and off time.

This pulsing relay may be combined with a flexible limit, which can be programmed with a function like low battery voltage to get a blinking warning light.

- Relay 2 is the discrete output [DO 2] and Flag 5 is used as an auxiliary flag.
- Relay 2 will be ON (energized) for 2 seconds and then OFF (de-energized) for 2 seconds as long as the easYgen is in automatic mode.

#### Configuring "Flag 5" for a pulsing relay

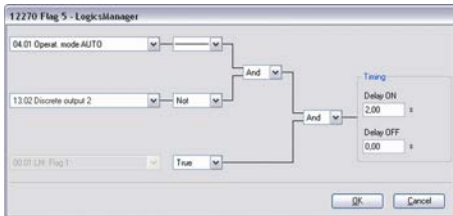

Fig. 167: LogicsManager function "Flag 5"

- ➔ Configure the LogicsManager function "Flag 5" as shown in ( Fig. 167).

⇒ In this example is the Delay ON time in the Logics-Manager of Flag 5 indicates how long the pause is. The Delay OFF time of Relay 2 is the pulse duration.

#### Configuring "Relay 2" for a pulsing relay

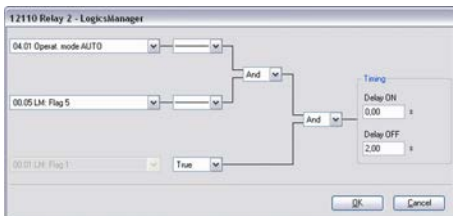

Fig. 168: LogicsManager function "Relay 2"

- ➔ Configure the LogicsManager function "Relay 2" as shown in ( Fig. 168).

## 6.4.4 Changing A Starter Battery Set



*This function is set up with the LogicsManager.*

The following programming example shows how two relay outputs are energized in turns when discrete input 9 is energized.

At first discrete output 11 will be energized, then, discrete output 12 will be energized, then discrete output 11 and so on.

This logic may be used to change between two starter battery sets for each starting cycle.

### Configuration

Configure Relay 11 and Relay 12 as well as the Flags 2, 3, 4, and 5 as shown in the following example.

You may also use the discrete input, which starts the engine by default [DI 02] or any other input command instead of discrete input 9; for example the command variable 03.06 "Engine released".

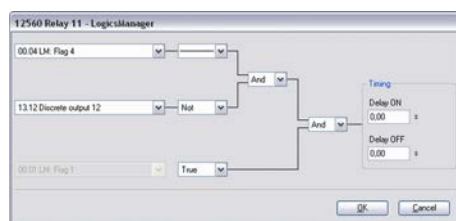

*Fig. 169: LogicsManager function "Relay 11"*

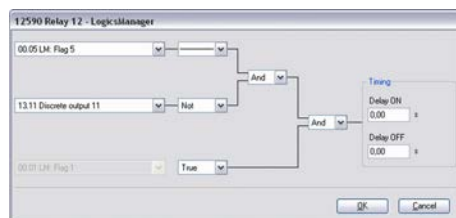

*Fig. 170: LogicsManager function "Relay 12"*

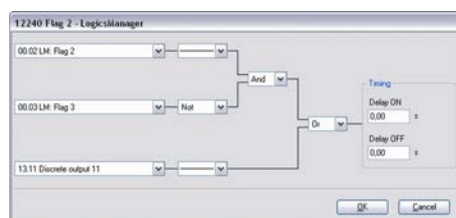

*Fig. 171: LogicsManager function "Flag 2"*

1. Configure the LogicsManager function "Relay 11" as shown in ( Fig. 169).

2. Configure the LogicsManager function "Relay 12" as shown in ( Fig. 170).

3. Configure the LogicsManager function "Flag 2" as shown in ( Fig. 171).

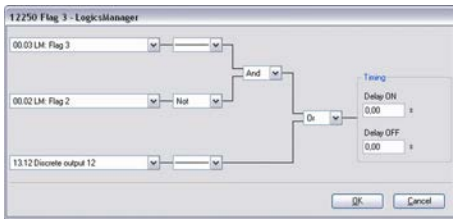

Fig. 172: LogicsManager function "Flag 3"

4. ➤ Configure the LogicsManager function "Flag 3" as shown in ( Fig. 172).

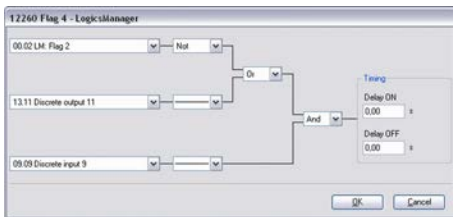

Fig. 173: LogicsManager function "Flag 4"

5. ➤ Configure the LogicsManager function "Flag 4" as shown in ( Fig. 173).

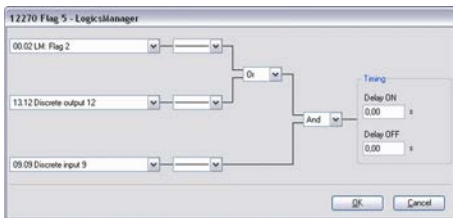

Fig. 174: LogicsManager function "Flag 5"

6. ➤ Configure the LogicsManager function "Flag 5" as shown in ( Fig. 174).

### 6.4.5 Performing Remote Start/Stop And Acknowledgement

The easYgen controller may be configured to perform start/stop/shutdown/acknowledgement functions remotely through the CAN bus or Modbus. The required procedure is detailed in the following steps.



Refer to [Chapter 5.2.2 "Basic Navigation"](#) on page 394 for a detailed description of the navigation through the various display screens.

A detailed description of the individual parameters may be found in [Chapter 4.5.11 "Automatic Run"](#) on page 278.

Be sure to enter the password for code level 2 or higher to be able to access the required configuration screens.

Refer to [Chapter 5.1.1 "Install ToolKit"](#) on page 383 for a description of the installation, configuration and usage of the ToolKit visualization and configuration application.



### Preliminary Conditions

We recommend to reset the unit to factory settings before proceeding.

Refer to [Chapter 4.1.5 "System Management"](#) on page 92 for reference.

The LogicsManager factory settings are shown in [Chapter 9.4.5 "Factory Settings"](#) on page 723.

## 6.4.5.1 Operating Modes

Two operating modes may be used with remote control:

- AUTOMATIC
- STOP

It is possible to fix the operating mode using the LogicsManager function 00.16 "Operat. mode AUTO" (parameter 12510 [p. 280](#)).

### AUTOMATIC

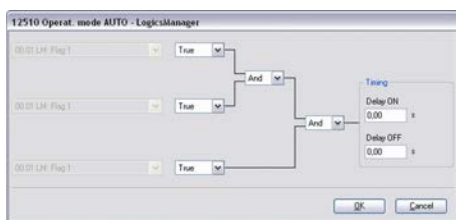

Fig. 175: LogicsManager function "Operat. mode AUTO"

➔ The LogicsManager function "Operat. mode AUTO" (parameter 12510 [p. 280](#)) can be configured as shown in (Fig. 175).

⇒ AUTOMATIC operation mode is always enabled.

If an alarm of alarm class C through F occurs in AUTOMATIC operating mode, the control does not return to STOP operating mode. If the alarm is cleared after acknowledgement a restart is initiated.

It is also possible to configure a discrete input for controlling the operating mode using the LogicsManager function 00.16 "Operat. mode AUTO" (parameter 12510 [p. 280](#)) and 00.18 "Operat. mode STOP" (parameter 12530 [p. 280](#)).

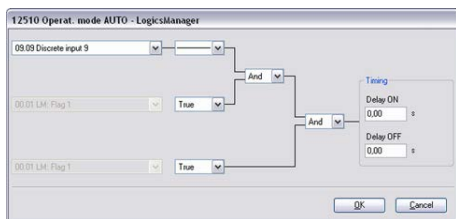

Fig. 176: LogicsManager function "Operat. mode AUTO"

➔ The LogicsManager function "Operat. mode AUTO" (parameter 12510 [p. 280](#)) can be configured as shown in (Fig. 176).

⇒ AUTOMATIC operation mode is enabled as soon as discrete input 9 is energized.

**STOP**

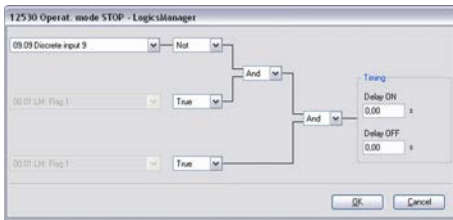

Fig. 177: LogicsManager function "Operat. mode STOP"

→ The LogicsManager function "Operat. mode STOP" (parameter 12530 ↪ p. 280) can be configured as shown in (Fig. 177).

⇒ STOP operation mode is enabled as soon as discrete input 9 is de-energized.

**6.4.5.2 Setting Up A Test With Or Without Load**

There are a lot of different opinions of the behavior of a proper test mode. The easYgen controller is supporting the following two modes:

- Test with load
- Test without load



*Both modes work only in automatic mode. The correct test mode depends on your local specifications.*

**Test with load**

This is the LogicsManager function "Start req. in AUTO" (parameter 12120 ↪ p. 279). No special message appears on the display.

If the mains fail during start in auto, the unit keeps running until the mains return and the mains settling time is expired or the conditions for "Start req. in AUTO" are FALSE again. The result depends on which condition is active longer.

**Test without load**

This is the LogicsManager function "Start w/o load" (parameter 12540 ↪ p. 279). If the conditions for this LogicsManager function are TRUE, the engine will provide an automatic starting sequence and keep the generator running until this function is FALSE again.

Then the unit will perform an automatic stop sequence and remain in standby in auto mode.

The message "Start w/o load" is displayed during the test without load. If the mains fails during test without load and the emergency mode is enabled, the unit will take over the load.

The unit will open the MCB and close the GCB. When the mains return, it will transfer the load back to the mains according to the configured breaker transition mode after the mains settling timer has expired. The engine will keep running until the conditions for "Start w/o load" are FALSE again.

**Example for test without load**

The engine shall start once a month and run for one hour without overtaking the load. The test day shall be every fifteenth of a month (with flag 2). A relay output can be configured to indicate if this test is running, e.g. for a signal lamp.

1. ➤ Configure the parameters listed below to set up the timer.

ID	Parameter	Value	Comment
1663	Active day	15	The active day is enabled every fifteenth of the month
1662	Active hour	10	The active hour is enabled between 10:00 and 11:00 am every day

Table 70: Timer configuration

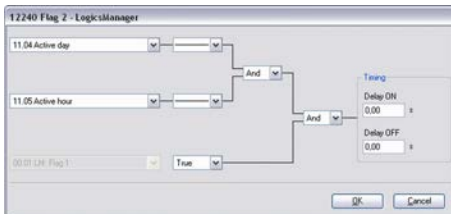

Fig. 178: LogicsManager function "Flag 2"

2. ➤ Configure the LogicsManager function "Flag 2" (parameter 12240 ↪ p. 376) as shown in (Fig. 178).
  - ⇒ Flag 2 becomes TRUE as soon as the configured active day and active time is reached.

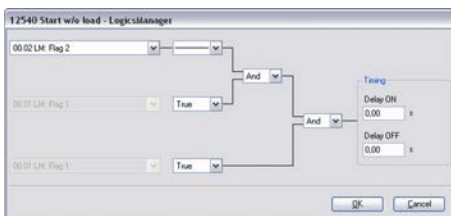

Fig. 179: LogicsManager function "Start without load"

3. ➤ The LogicsManager function "Start without load" (parameter 12540 ↪ p. 279) can be configured as shown in (Fig. 179).
  - ⇒ Start without load mode is enabled as soon as Flag 2 becomes TRUE.

### 6.4.5.3 Remote Start/Stop, Shutdown, And Acknowledgement

The easYgen may be start, stop, shut down, or acknowledged alarms with Modbus or CAN protocol via the interface.

Therefore, two logical command variables (04.13 and 04.14) have to be configured with the LogicsManager. 03.40 can handle Remote shutdown only.

- 04.13 Remote request
- 04.14 Remote acknowledge
- 03.40 Remote shutdown

A Remote shutdown 03.40 can be configured via LogicsManager internal flag (e.g.12230 Flag 1) combined with a free alarm LogicsManager (e.g. Free alarm 1) configured with shutdown alarm class.

How to handle a Remote request 04.13 and a Remote acknowledge 04.14 is described below in detail.

#### Start request in AUTOMATIC operating mode

1. ➤ Either on the front panel or using ToolKit navigate to menu "Configure automatic run".
2. ➤ Open the LogicsManager for entry "Start req in AUTO".

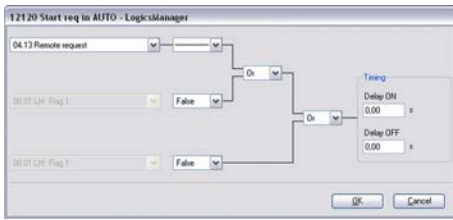

Fig. 180: LogicsManager function "Start req in AUTO"

3. ➤ Configure the LogicsManager function "Start req in AUTO" as shown in ( Fig. 180).
  - ⇒ With this setting, the "Start req in AUTO" LogicsManager output becomes TRUE as soon as the remote request signal is enabled.



The LogicsManager commands 2 and 3 may be used to configure additional conditions like discrete inputs, which must be energized to be able to issue the remote start request.

### External acknowledgement

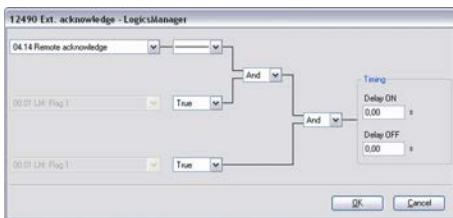

Fig. 181: LogicsManager function "Ext. acknowledge"

1. ➤ Either on the front panel or using ToolKit navigate to menu "Configure monitoring → Configure global settings".
2. ➤ Open the LogicsManager 00.15 for entry "Ext. acknowledge".
3. ➤ Configure the LogicsManager function "Ext. acknowledge" as shown in ( Fig. 181).
  - ⇒ With this setting, the "Ext. acknowledge" LogicsManager output becomes TRUE as soon as the remote acknowledge signal is enabled.



The LogicsManager commands 2 and 3 may be used to configure additional conditions like discrete inputs, which must be energized to be able to issue the remote acknowledge command.

Please refer to [Chapter 6.6 "Modbus Applications" on page 498](#) for a description of how to configure the LogicsManager functions via Modbus.



All interfaces access the same bits. The command variable "04.13 Remote request" remains enabled in the easYgen until a new command is sent or the power supply failed or is removed.

#### Remote start:

- The command variable "04.13 Remote request" changes to "1" (high) if the start bit (ID 503, bit 0) changes from "0" to "1".
- The command variable "04.13 Remote request" changes to "0" (low) if the stop bit (ID 503, bit 1) changes from "0" to "1" ( Fig. 182).



## Acknowledgement:

- The command variable "04.14 Remote acknowledge" reflects the acknowledgement bit (ID 503, bit 4).
- An acknowledgement is generally performed twice:
  - 1st change of the logical output "External acknowledge" from "0" to "1":  
Silence horn
  - 2nd change of the logical output "External acknowledge" from "0" to "1":  
Acknowledges all inactive alarms

## System reaction



*The easYgen does NOT react on the disabling of the start bit, but only on the enabling of the stop bit.*

*This has the advantage that it is not required to maintain the connection established for the whole time in case of a remote start.*

The following figure shows the reaction of the command variable on the various changes of the bits:

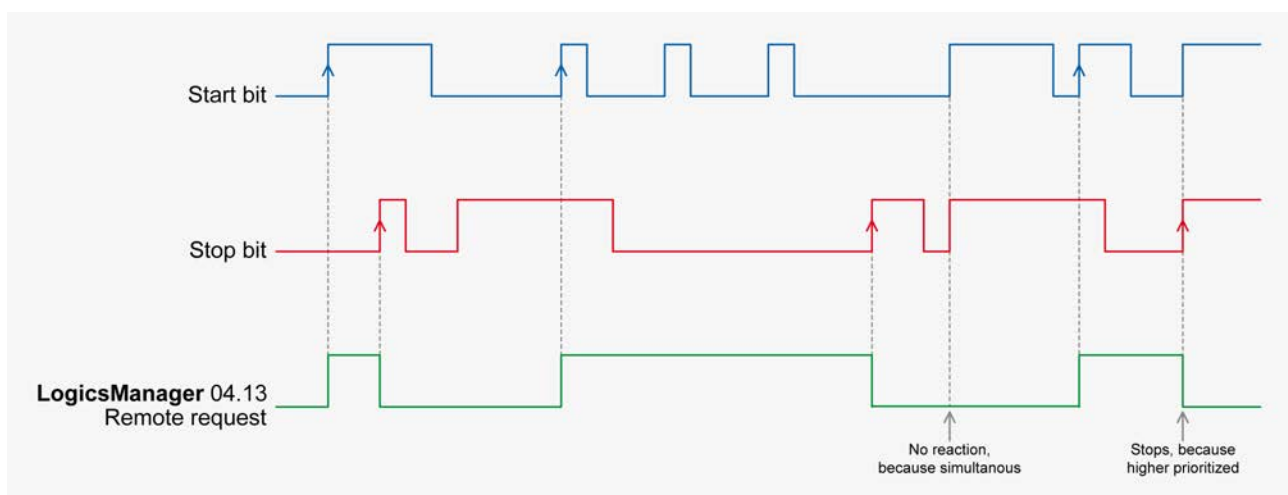

Fig. 182: Command variable

Enabling the bits may be performed with the following methods:

- Bit Enabling via Modbus Protocol and RS-485 Interface
- Bit Enabling via CANopen Protocol and CAN Interface 1

### Bit enabling via Modbus protocol and RS-485 interface

The parameter Modbus Slave ID must be configured.

The control bits are sent on address 503 for a start via Modbus:

- Bit 0: Start
- Bit 1: Stop
- Bits 2 and 3: must be "0" (for the watchdog).
- Bit 4: Acknowledgement
- Bit 9: Shutdown command



*Please refer to [Chapter 6.6 "Modbus Applications"](#) on page 498 for a description of how to enable control bits via Modbus.*

### Bit enabling via CANopen protocol and CAN interface 1



*For further information on the CANopen protocol refer to ↗ Chapter 7.4 “CANopen Protocol” on page 524 and the CANopen file \*.eds, which is delivered with the unit.*

*Please refer to ↗ Chapter 6.6 “Modbus Applications” on page 498 for a description of how to enable control bits via CAN bus.*

### Remote Shutdown

For controlling the device with Remote Shutdown 03.40 please run setup as described above but with 03.40 instead of 04.14 and using Bit 9 instead of Bit 0, 1, and 4.

Additionally

- define a free LM flag for 03.40 Remote Shutdown and
- take it as input for a Free alarm
- with a shutdown alarm class.

## 6.4.6 Connecting An IKD 1 On CAN Bus 1



*We recommend to connect external expansion boards, like the Woodward IKD 1 to CAN bus 2.*

*This CAN bus offers preconfigured settings for operating several expansion boards including the IKD 1.*

*However, it is also possible to connect an IKD 1 to CAN bus 1.*

Refer to the ↗ Chapter 4.6.1.3 “Transmit PDO {x} (Process Data Object)” on page 358 and ↗ Chapter 4.6.1.2 “Receive PDO {x} (Process Data Object)” on page 355 for the configuration of the parameters concerned.

Refer also to ↗ Chapter 7.4 “CANopen Protocol” on page 524 for a description of the data objects.

The easYgen may either be configured directly using the front panel or externally using the ToolKit software.

### Transmit PDO

The easYgen must be configured for sending to data protocol 65000 (external DOs 1 to 8) and CAN ID 181 (hex) every 20 ms on TPDO1.



#### **LSG connected on CAN 1**

*The upper described ID 181 (hex) can not be used if a LSG and a legacy device like GCP 30, GCP 20, MFR-2 are connected on CAN 1! The legacy devices are using IDs 181 - 18E (hex) but can not be switched to another ID.*

TPDO is used to send messages to an external device.

Configure TPDO1 as shown below.

ID	Parameter	Value	Comment
9600	COB-ID	181 (hex) / 385 (dec)	The COB-ID is configured to 181 (hex) or 385 (dec)
9602	Transmission type	255	Data is automatically broadcasted (transmission type 255)
9604	Event timer	20 ms	The event timer is configured to 20 ms
8962	Selected Data Protocol	65000	Data protocol 65000 is selected

Table 71: TPDO1 configuration

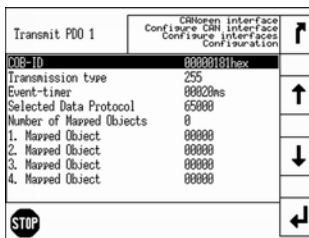

Fig. 183: TPDO configuration for IKD 1 (example HMI)

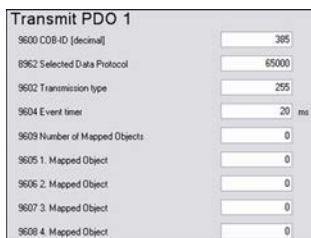

Fig. 184: TPDO configuration for IKD 1 (example ToolKit)

⇒ ( Fig. 183) and ( Fig. 184) display the example TPDO configuration for IKD 1.

## Receive PDO

The easYgen must be configured for receiving data on an RPDO. The data received on CAN ID 201h is interpreted as data protocol 65000 (external DIs 1 to 8).

➔ Configure RPDO1 as shown below.

ID	Parameter	Value	Comment
9300	COB-ID	201 (hex) / 513 (dec)	The COB-ID is configured to 201 (hex) or 513 (dec)
9121	Event timer	2000 ms	The event timer is configured to 2000 ms
8970	Selected Data Protocol	65000	Data protocol 65000 is selected

Table 72: RPDO1 configuration

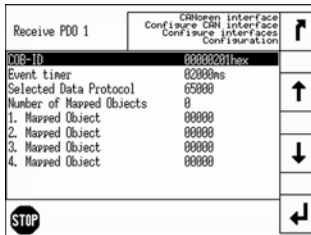

Fig. 185: RPDO configuration for IKD 1 (example HMI)

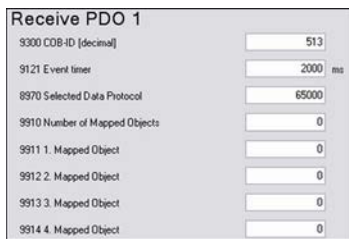

Fig. 186: RPDO configuration for IKD 1 (example ToolKit)

⇒ ( Fig. 185) and ( Fig. 186) display the example RPDO configuration for IKD 1.

**IKD 1 configuration**

Refer to the IKD 1 Manual 37135 for the configuration of the unit and the parameters concerned. Please note that the DPC cable (P/N 5417-557) together with the LeoPC1 software (delivered with the DPC cable) is required to configure the IKD 1.

➔ Configure IKD 1 as shown below to communicate with an easYgen.

ID	Parameter	Value	Comment
-	CAN Node-ID	0	The CAN Node-ID is configured to 0
-	CAN ID receive data	385 (dec)	The CAN ID for receive data is configured to 385 (dec)
-	CAN ID send data	513 (dec)	The CAN ID for send data is configured to 513 (dec)
-	Physical state only	Yes	Only the physical state of the IKD 1 inputs is evaluated

Table 73: IKD 1 configuration

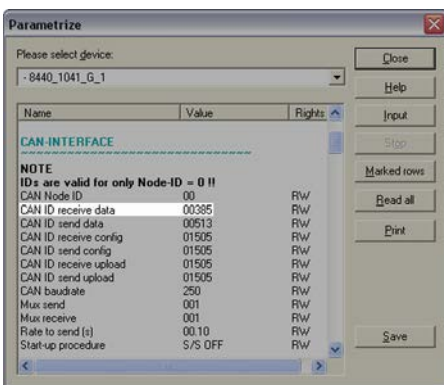

Fig. 187: IKD 1 configuration (example LeoPC1)

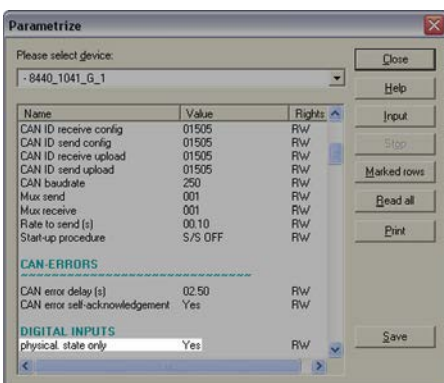

Fig. 188: IKD 1 configuration (example LeoPC1)

⇒ ( Fig. 187) and ( Fig. 188) display the example IKD 1 configuration.

**Baud rate configuration**

The baud rate must be configured identical in the easYgen and the IKD 1. The following example shows the configuration of both units to 250 kBd.

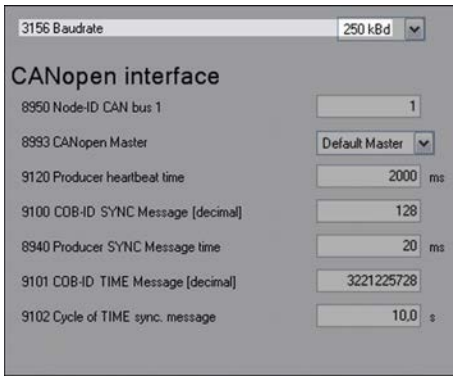

Fig. 189: Baud rate configuration (example ToolKit)

1. In ToolKit configure the baud rate as shown in ( Fig. 189).

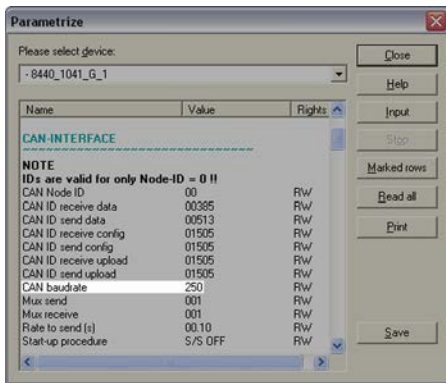

Fig. 190: Baud rate configuration (example LeoPC1)

2. For the first IKD 1 configure the baud rate as shown in ( Fig. 190).

Configuration for a second IKD 1

To connect a second IKD 1 to the easYgen:

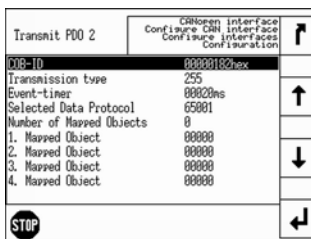

Fig. 191: TPDO configuration for 2nd IKD 1 (example HMI)

1. Set up TPDO2 for the easYgen on the front panel as shown in ( Fig. 191).

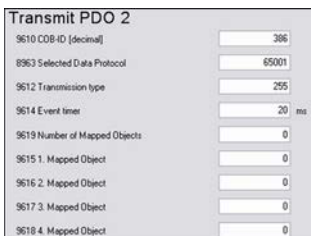

Fig. 192: TPDO configuration for 2nd IKD 1 (example ToolKit)

⇒ Set up TPDO2 for the easYgen in ToolKit as shown in ( Fig. 192).

COB-ID	hex
Event timer	02000ms
Selected Data Protocol	65001
Number of Mapped Objects	9
1. Mapped Object	00000
2. Mapped Object	00000
3. Mapped Object	00000
4. Mapped Object	00000

2. → Set up RPDO2 for the easYgen on the front panel as shown in ( Fig. 193).

Fig. 193: RPDO configuration for 2nd IKD 1 (example HMI)

Parameter ID	Value
9310 COB-ID [decimal]	514
9122 Event timer	2000 ms
9371 Selected Data Protocol	65001
9915 Number of Mapped Objects	0
9916 1. Mapped Object	0
9917 2. Mapped Object	0
9918 3. Mapped Object	0
9919 4. Mapped Object	0

- ⇒ Set up RPDO2 for the easYgen in ToolKit as shown in ( Fig. 194).

Fig. 194: RPDO configuration for 2nd IKD 1 (example ToolKit)

## 6.4.7 Configuring A PWM Duty Cycle For A CAT ADEM Controller

If a PWM signal shall be used with a CAT ADEM speed controller, the duty cycle must be limited between 10 % and 85 %.

For this, the following settings must be made to the respective analog output



The following parameter IDs and figures refer to analog output 1.

Note, that another analog output may also be used.

➔ Configure the parameters as shown below.

ID	Parameter	Value	Comment
5200	Data source	[00.03] Speed bias	A speed signal will be output
5201	Selected hardware type	User defined	A user-defined hardware type will be used
5208	User defined min. output value	10.00 %	The minimum output value of the user-defined hardware type is 10 %
5209	User defined max. output value	85.00 %	The minimum output value of the user-defined hardware type is 85 %
5202	PWM signal	On	The PWM signal is enabled
5210	PWM output level	10.00 V	The PWM output level is configured to 10 V

Table 74: PWM duty cycle configuration

⇒ The finished configuration in ToolKit is shown in ( Fig. 195).

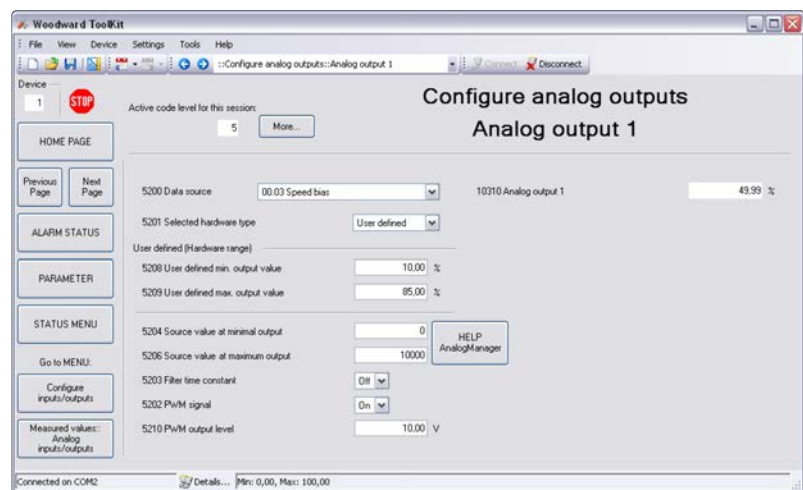

Fig. 195: PWM duty cycle for a CAT ADEM controller (example ToolKit)

### 6.4.8 Connecting A GSM Modem

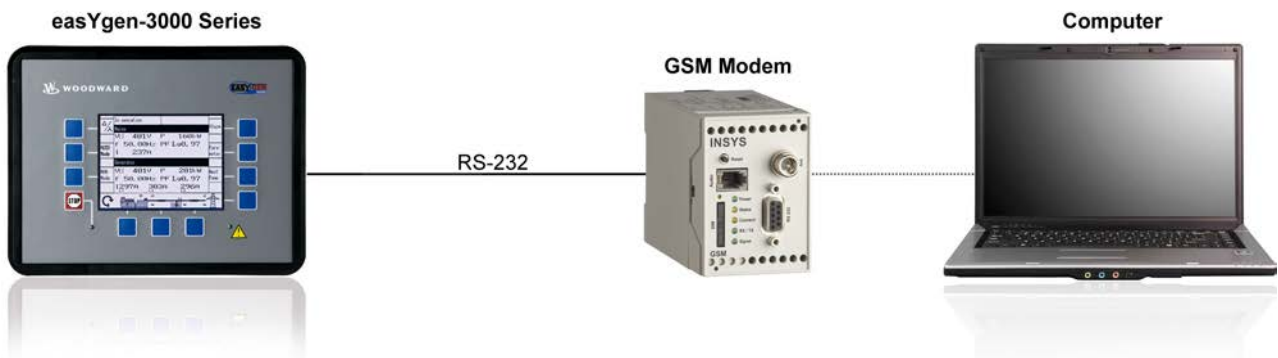

Fig. 196: Connecting a GSM modem



It is possible to establish a cellular connection to the system using a GSM modem. This application is intended for mobile use. It is also interesting to trigger a call in case of an alarm with this application. The GSM modem provides a discrete input for this, which can trigger e.g. a short message (SMS).

Depending on the network provider, it can also be possible to send a fax message).

Different actions can be performed 'online' using the ToolKit application software, which is delivered on the CD-ROM with the control.

These actions include:

- Configuration
- Visualization
- Transfer settings to and from the hard drive

### Prerequisites for this example

- Straight serial cable for connecting the easYgen with the GSM modem
- Wireless modem INSYS GSM 4.2 with antenna (<http://www.insys-tec.de>)
- SIM card with data transfer enabled (to be enabled by the GSM provider)
- PC with Windows XP or Vista operating system with modem (we recommend to use the Windows standard driver for older modems (e.g. ELSA Microlink 56k) if the dedicated driver does not work)
- Configuration software ToolKit version 3.1 or higher
- Configuration files available (\*.sid, \*.wtool)
- FAX/SMS receiver for receiving alarm messages



*If a SIM card is used, which is enabled to send SMS messages, an SMS can be sent by the GSM modem.*

*To establish a data connection, data transfer has to be enabled by the network provider.*



*The INSYS GSM Modem 4.2 has two discrete inputs, which can be used to send two different alarm messages.*

*One relay of the easYgen is required for each alarm message.*



*The dispatch of an alarm message is performed by the modem after energizing a discrete input.*

*If a different modem is used, this has to accept incoming calls automatically and establish a connection between calling PC and easYgen.*

### Connection

It is possible to issue an active call in case of a malfunction using a relay of the relay manager.

1. Connect the easYgen and the modem with the power supply as directed.

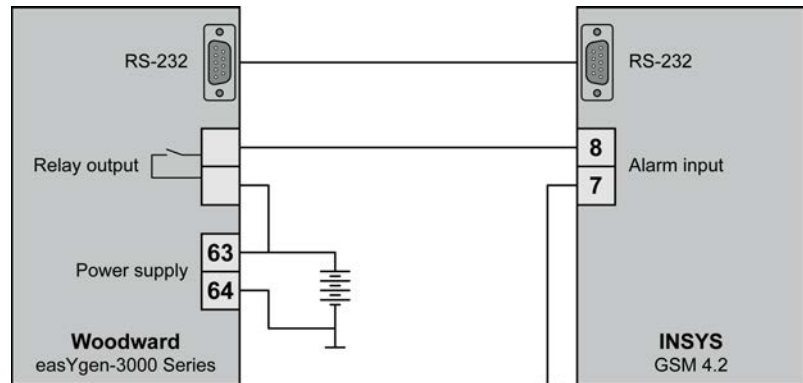

Fig. 197: GSM modem wiring

2. Use the straight RS-232 cable delivered with the GSM modem for connecting the easYgen with the modem.  
When commissioning the system, use a null modem cable to configure the easYgen via a PC with ToolKit.

easYgen settings

1. Configure the following parameters to connect to the modem for configuration purposes (the same settings must be configured in the modem):

ID	Parameter	Value	Comment
3163	Baudrate	9.6 kBd	The baud rate is set to 9.6 kBaud
3161	Parity	No	The transmission protocol is configured without parity
3162	Stop bits	One	The transmission protocol is configured with one stop bit

Table 75: easYgen settings

**i** *If the transmission quality of the phone line is poor, the baud rate should be lowered since no data flow control is performed between easYgen and modem.*

*Generally, the connection via modem is a bit slower than a direct connection of PC and easYgen.*

*The maximum baud rate depends on the used modem. The easYgen supports the following baud rates: 2400, 4800, 9600, 14400, 19200, 38400, 65000, and 115000 Bauds.*

2. Configure the relay(s) connected with the modem using the easYgen LogicsManager ( [Chapter 9.4.1 “LogicsManager Overview” on page 689](#)).

## ToolKit settings



Fig. 198: Connect modem

- ➔ In ToolKit, select “Connect...” from the “Device” menu to open the “Communications” window.

Select the modem (this must be installed and configured under Windows) from the network list, enter the phone number and click the “Connect” button to establish a connection with the modem.

## GSM modem settings

INSYS Microelectronics provides the application software HS-COMM to configure the GSM modem for the application.

The following settings show an example for sending an alarm message as a short message.



*Descriptions of the individual parameters can be taken from the operation manual of the modem.*

To configure the modem, proceed as follows:

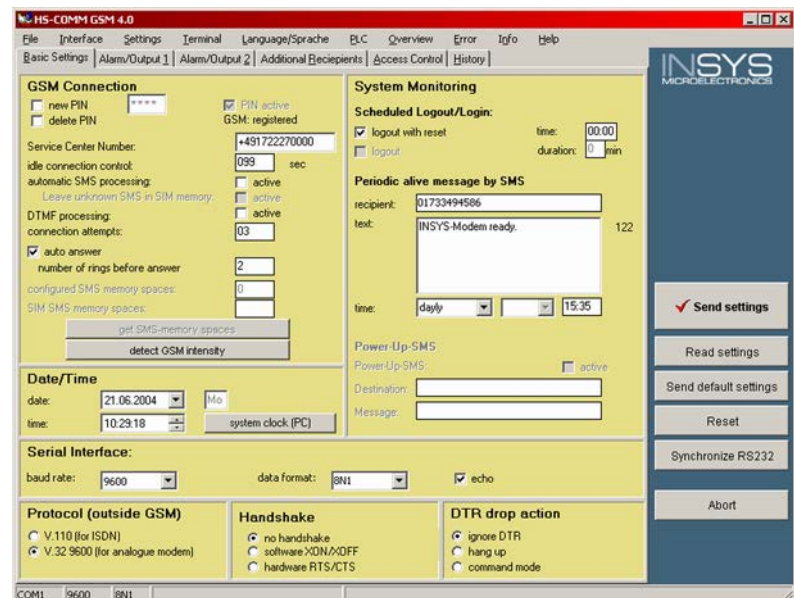

Fig. 199: GSM modem - basic settings

- ➔ Set up the modem as shown in ( Fig. 199) on the “Basic Settings” tab.

These settings configure the modem to accept an incoming call for remote configuration.

The phone number and text can be configured as required.

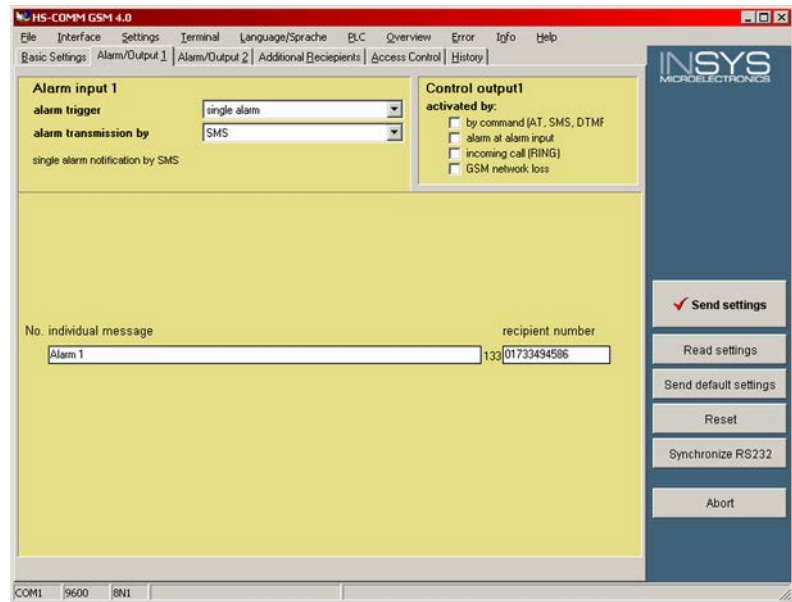

Fig. 200: GSM modem - alarm/output 1

2. ➤ Set up the modem as shown in ( Fig. 200) on the “Alarm/Output 1” tab.

The phone number and the text can be set as required.

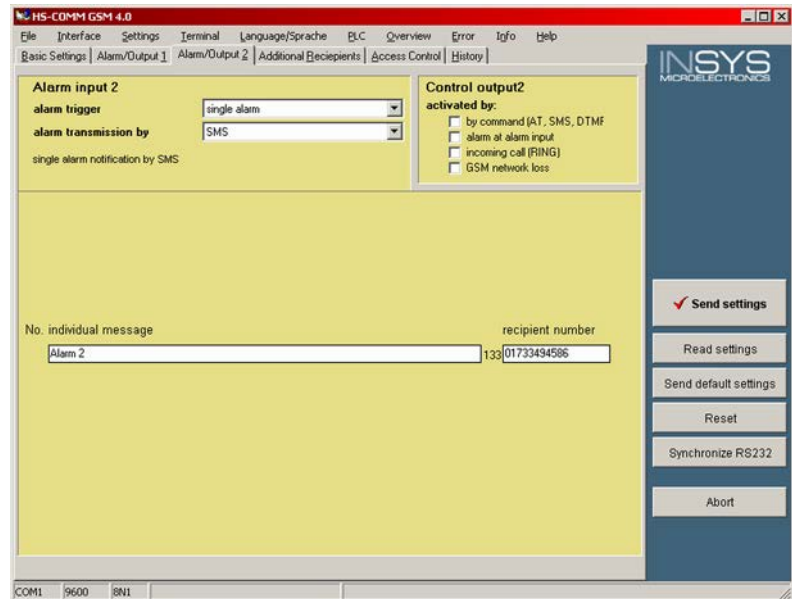

Fig. 201: GSM modem - alarm/output 2

3. ➤ Set up the modem as shown in ( Fig. 201) on the “Alarm/Output 2” tab.

## 6.4.9 Connecting A Landline Modem



Fig. 202: Connecting a landline modem

It is possible to establish a phone connection to the system using a modem. This application is intended for stationary use, where a steady remote control is required.

It is also interesting to trigger a call in case of an alarm with this application. The Phoenix modem provides a discrete input for this, which can trigger e.g. a call or a fax message.

Different actions can be performed 'online' using the ToolKit application software, which is delivered on the CD-ROM with the control unit.

These actions include:

- Configuration
- Visualization
- Transfer settings to and from the hard drive

### Prerequisites for this example

- Straight serial cable for connecting the easYgen with the modem
- Phoenix PSI data/fax modem/RS232 ([www.phoenixcontact.com](http://www.phoenixcontact.com))
- PC with Windows XP or Vista operating system with modem (we recommend to use the Windows standard driver for older modems (e.g. ELSA Microlink 56k) if the dedicated driver does not work)
- Configuration software ToolKit version 3.1 or higher
- Configuration files available (\*.sid, \*.wtool)
- FAX/SMS receiver for receiving alarm messages



*Sending an SMS via the fixed-network line may be enabled by the network provider.*



*The Phoenix PSI-Data/Fax-Modem/RS232 has one discrete input, which can be used to send an alarm message.*

*One relay of the easYgen is required for the alarm message.*

*It is also possible to use the switch output of the modem to operate a discrete input of the easYgen, for example for a remote start.*



*The dispatch of an alarm message is performed by the modem after energizing a discrete input.*

*If a different modem is used, this has to accept incoming calls automatically and establish a connection between calling PC and easYgen.*

### Connection

It is possible to issue an active call in case of a malfunction using a relay of the relay manager.

1. Connect the easYgen and the modem with the power supply as directed.

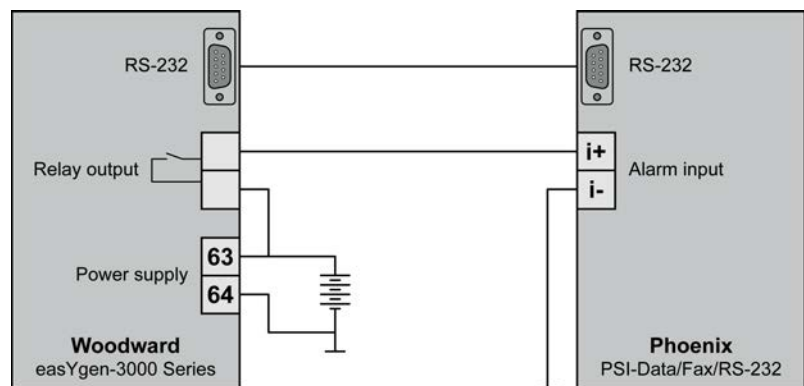

*Fig. 203: Landline modem wiring*

2. Use a straight RS-232 cable (not delivered with the modem) for connecting the easYgen with the modem.

When commissioning the system, use a null modem cable to configure the easYgen via a PC with ToolKit.

## easYgen settings

1. ➔ Configure the following parameters to connect to the modem for configuration purposes (the same settings must be configured in the modem):

ID	Parameter	Value	Comment
3163	Baudrate	4.8 kBd	The baud rate is set to 4.8 kBaud
3161	Parity	No	The transmission protocol is configured without parity
3162	Stop bits	One	The transmission protocol is configured with one stop bit

Table 76: easYgen settings



*If the transmission quality of the phone line is poor, the baud rate should be lowered since no data flow control is performed between easYgen and modem.*

*Generally, the connection via modem is a bit slower than a direct connection of PC and easYgen.*

*The maximum baud rate depends on the used modem. The easYgen supports the following baud rates: 2400, 4800, 9600, 14400, 19200, 38400, 65000, and 115000 Bauds.*

2. ➔ Configure the relay(s) connected with the modem using the easYgen LogicsManager ( [Chapter 9.4.1 "LogicsManager Overview" on page 689](#)).

## ToolKit settings



Fig. 204: Connect modem

- ➔ In ToolKit, select "Connect..." from the "Device" menu to open the "Communications" window.

Select the modem (this must be installed and configured under Windows) from the network list, enter the phone number and click the "Connect" button to establish a connection with the modem.

## Landline modem settings

Phoenix provides an application software to configure the modem for the application.



*Descriptions of the individual parameters can be taken from the operation manual of the modem.*

To configure the modem, proceed as follows:

1. Make sure all DIP switches are set to OFF (default state).
2. Configure the COM port ( Fig. 205).

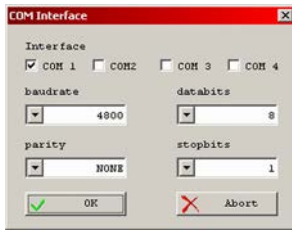

Fig. 205: COM port setting

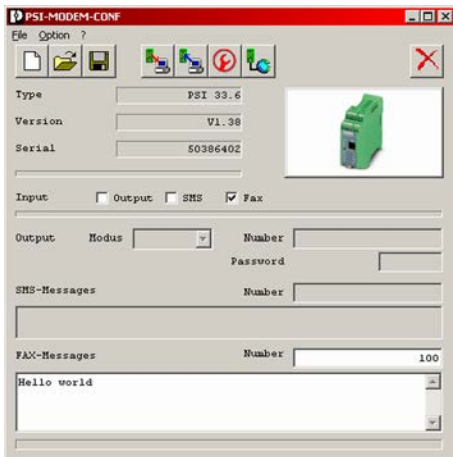

Fig. 206: Phone number/text setting

3. The phone number and the text can be set as required ( Fig. 206).

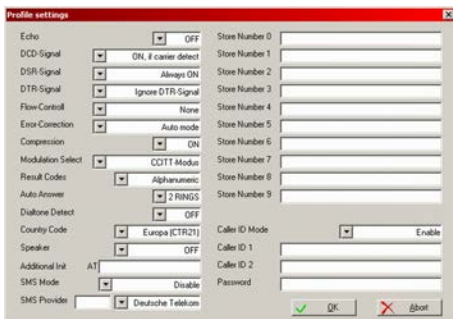

Fig. 207: Profile settings

4. Configure the settings shown in ( Fig. 207) for the modem to accept an incoming call for remote configuration.



### 6.4.10 Wiring Self Powered Discrete Inputs

In order to create self-powered discrete inputs:

1. Connect battery negative (B-) to ground and PE (terminal 61).

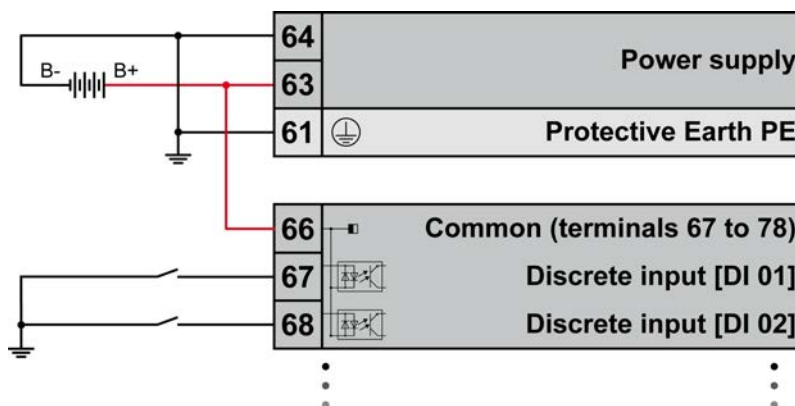

Fig. 208: Wiring self-powered discrete inputs

2. Connect DI common (terminal 66) to power supply 12/24 V (terminal 63, minimum wire size 0.5 mm<sup>2</sup> (20 AWG)).  
 ⇒ This enables to energize the discrete inputs against ground.

### 6.4.11 Connecting Analog Inputs In Series

The analog inputs of the easYgen-3000 Series are galvanically isolated. This enables a series connection for up to 3 analog inputs. This connection allows for example to share a power setpoint for up to 3 devices.

The example shows the terminal numbers for the analog input 3, but in principle it works for all analog inputs which support a 0 to 20 mA signal.

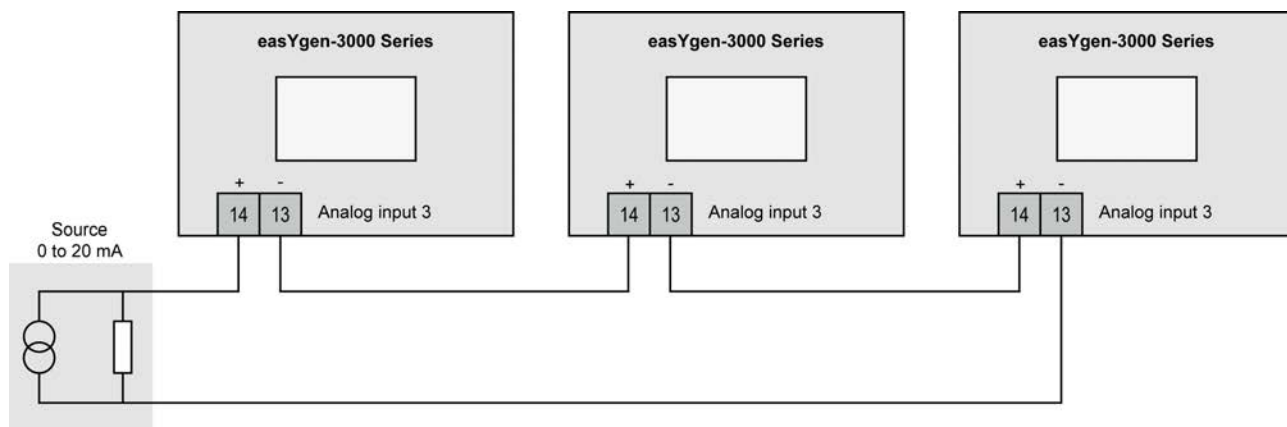
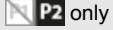







Fig. 209: Connecting analog inputs in series

### 6.4.12 Setup Phoenix Expansion Modules

#### Supported Phoenix modules

Bus coupler	Discrete outputs	Discrete inputs	Analog outputs	Analog inputs
IL CAN BK	IB IL 24 DO 2	IB IL 24 DI 2	IB IL AO 2/SF 	IB IL AI 2/SF 
	IB IL 24 DO 8	IB IL 24 DI 4		IB IL TEMP 2 UTH 
	IB IL 24 DO 16	IB IL 24 DI 8		IB IL TEMP 2 RTD 
	IB IL 24 DO 32 	IB IL 24 DI 16		
	IB IL 24/230 DOR4/W	IB IL 24 DI 32 		



*Phoenix module ILB CO 24 DI 16 DO 16 is not supported.*

#### Possible combinations

The possible combinations of Phoenix modules are listed below. The parameters display the maximum extension.

It is also possible to connect fewer modules. For example choose parameter 9941  p. 363 (12AI 4AO) for connecting 10 AI and 1 AO.

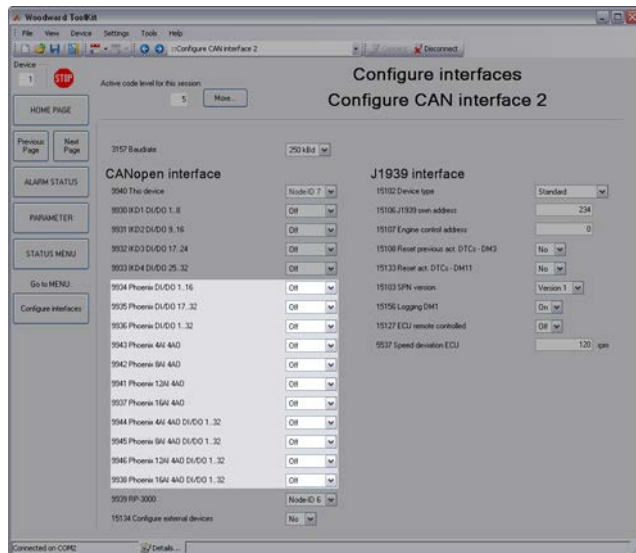

Fig. 210: Configuring Phoenix modules

It is possible to use multiple Phoenix modules with one bus coupler. Each single value in the screenshot ( Fig. 210) can be handled by one bus coupler.











	Di/DO 1..16	Di/DO 17..32	Di/DO 1..32	4AI 4AO	8AI 4AO	12AI 4AO	16AI 4AO	4AI 4AO DI/DO 1..32	8AI 4AO DI/DO 1..32	12AI 4AO DI/DO 1..32	16AI 4AO DI/DO 1..32
Di/DO 1..16		x		x	x	x	x				
Di/DO 17..32  only	x			x	x	x	x				
Di/DO 1..32  only				x	x	x	x				
4AI 4AO  only	x	x	x								
8AI 4AO  only	x	x	x								
12AI 4AO  only	x	x	x								
16AI 4AO  only	x	x	x								
4AI 4AO DI/DO 1..32  only											
8AI 4AO DI/DO 1..32  only											
12AI 4AO DI/DO 1..32  only											
16AI 4AO DI/DO 1..32  only											

Table 77: Phoenix module combinations



There is a maximum of three bus couplers on the CAN bus. There is also a maximum of 16AI 4AO DI/DO 1..32, which must not exceeded in all possible combinations.

**Setup baud rate**

Set the baud rate of CAN #2 in the easYgen and the Phoenix module to the same value. All members on the CAN bus need to have the same baud rate.

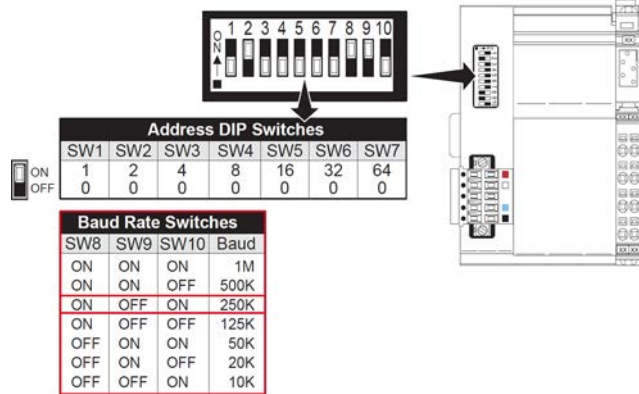
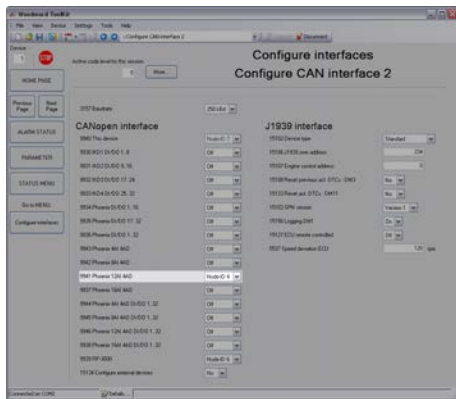

Fig. 211: Baud rate DIP switches

Each bus coupler has 10 DIP switches. These switches are located on the left side of the CANopen bus coupler. DIP switches 1 through 7 are used to set the node address and DIP switches 8 to 10 are used to set the baud rate.

**Set the Node-ID**



- Using ToolKit, set the Node-ID for the configuration you are using.

Fig. 212: Set the Node-ID

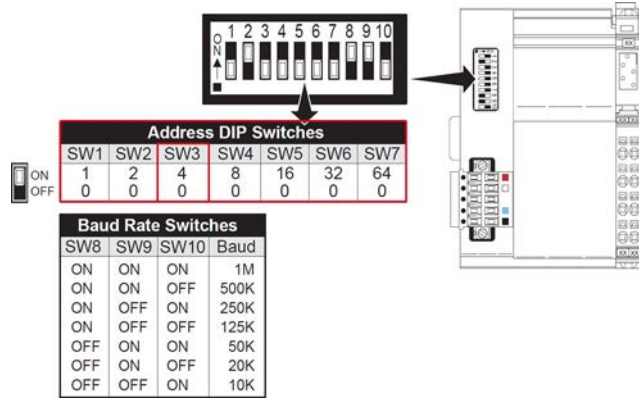

Fig. 213: Address DIP switches

2. Setup the corresponding DIP switches accordingly.

The node address is set using DIP switches 1 through 7. DIP switch 1 is the least significant digit of the node address and DIP switch 7 is the most. Valid node address settings range from 1 to 127.

**i** Note that the UL power will need to be cycled in order to implement any changes to the node address. Node address 0 is reserved, and used to auto-configure the I/O attached to the module. The unit will not go online at address 0.

3. Initialize the startup routine in the Phoenix device.
4. Set parameter 15134 p. 363 "Configure external devices" to "Yes" to confirm your changes in the easYgen.

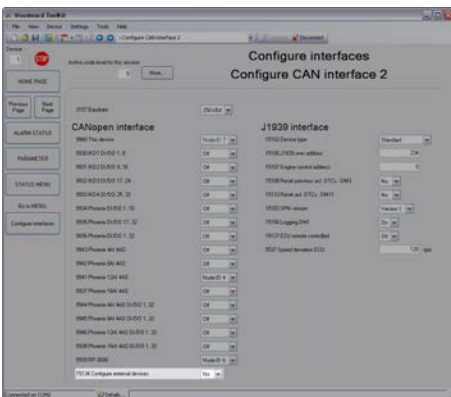

Fig. 214: Confirm changes

### 6.4.12.1 Configure External Inputs/Outputs (Phoenix)

#### Configure external DI

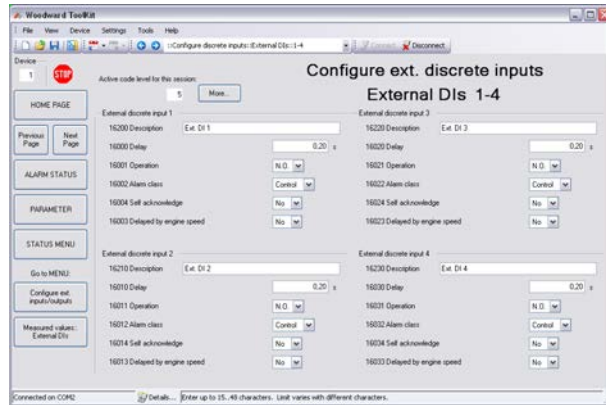

Fig. 215: Setup of external DIs

- ➔ Set up the external discrete inputs using the Toolkit screen shown in ( Fig. 215).

#### Configure external DO

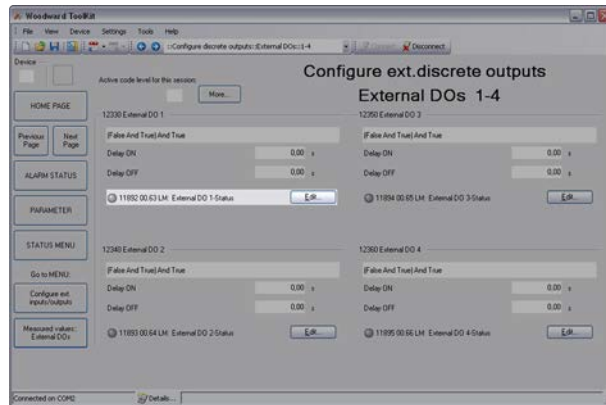

Fig. 216: Setup of external DOs

- ➔ Set up the external discrete outputs using the Toolkit screen shown in ( Fig. 216).
- ➔ Click "Edit" to open the respective LogicsManager screen of each output.

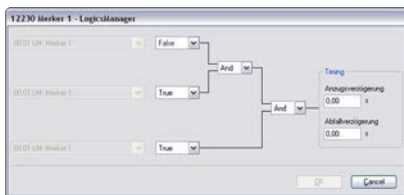

Fig. 217: LogicsManager

#### Configure external AI



The following applies to easYgen-3100/3200 (Package P2) only.

For getting an analog input to work, there are 3 major settings to adjust. The parameter numbers are examples for the first analog input, they are different for the second one.

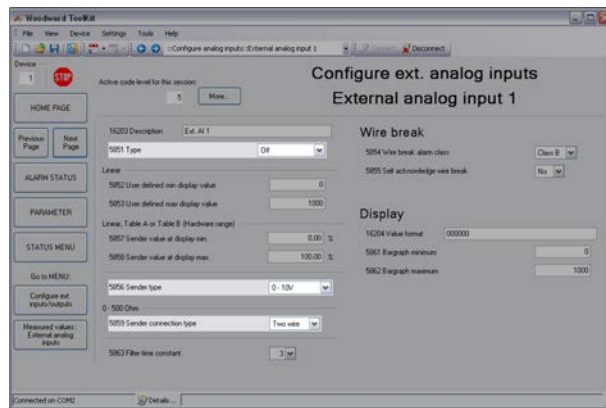

Fig. 218: Setup of external AIs

➔ Set up the external analog inputs using the ToolKit screen shown in ( Fig. 218).

- Parameter 5851 ↪ p. 243 "Type" defines the characteristic curve of the sensor.
- Parameter 5856 ↪ p. 244 "Sender Type" defines the sensor hardware (be sure that this value matches with the wired and connected extension board).
- Parameter 5859 ↪ p. 244 "Sender connection type" defines the wiring of the sensor.

The following table shows the possible configuration combination of the "Type" settings (parameter 5851 ↪ p. 243) and the "Sender type" setting (parameter 5856 ↪ p. 244).

Parameter Type	Sender Type	0 - 10V	±10V	0 - 20mA	±20mA	4 - 20mA	0 - 400 Ohm	0 - 4000 Ohm	Thermocouple	R0=100	R0=10	R0=20	R0=30	R0=50	R0=120	R0=150	R0=200	R0=240	R0=300	R0=400	R0=500	R0=1000	R0=1500	R0=2000	R0=3000
	OFF																								
Linear		X	X	X	X	X	X	X	X																
Table A		X	X	X	X	X	X	X	X																
Table B		X	X	X	X	X	X	X	X																
Thermo couple type K									X																
Thermo couple type J									X																
Thermo couple type E									X																
Thermo couple type R									X																
Thermo couple type S									X																
Thermo couple type T									X																
Thermo couple type B									X																
Thermo couple type N									X																
Thermo couple type U									X																
Thermo couple type L									X																
Thermo couple type C									X																
Thermo couple type W									X																
Thermo couple type HK									X																
Pt DIN(R0)										X	X	X	X	X	X	X	X	X	X	X	X	X	X	X	X
Pt SAMA(R0)										X	X	X	X	X	X	X	X	X	X	X	X	X	X	X	X
Ni DIN(R0)										X	X	X	X	X	X	X	X	X	X	X	X	X	X	X	X
Ni SAMA(R0)										X	X	X	X	X	X	X	X	X	X	X	X	X	X	X	X
Cu10																									
Cu50																									
Cu53																									
Ni 1000(Landis)																									
Ni 500(Viessm.)																									
KTY 81-110																									
KTY 84																									

Configuration of sender type is not used  
**NOT ALLOWED**  
**RIGHT CONFIGURATION**

Fig. 219: Supported sender types

Configure external AO

**i** The following applies to easYgen-3100/3200 (Package P2) only.

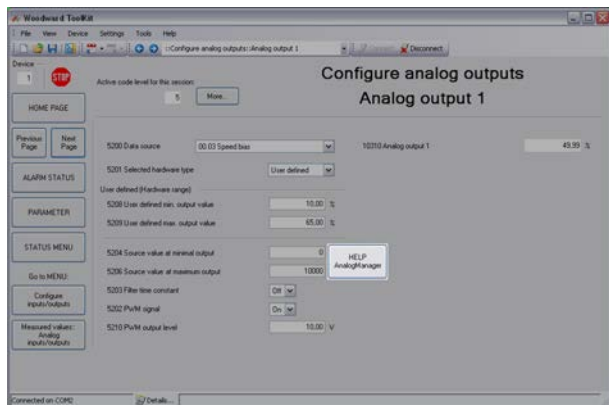

Fig. 220: Setup of external AOs

1. Configure the external analog outputs using the ToolKit screen shown in ( Fig. 220).
2. By clicking the "Help" button, you get further information and examples regarding the format you need to choose.





For a detailed description of all parameters see Chapter 4.5.8 "External Analog Outputs" on page 258.

## Confirm changes

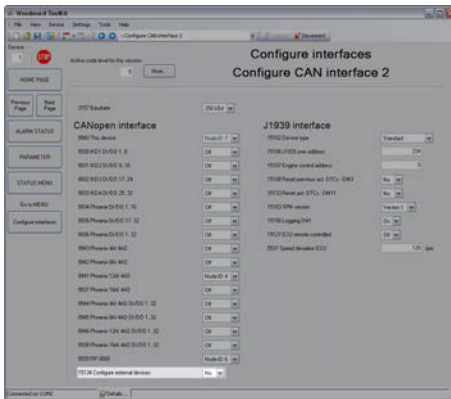

➔ Set parameter 15134 p. 363 "Configure external devices" to "Yes" to confirm your changes in the easYgen.

Fig. 221: Confirm changes

## 6.4.13 Phase Angle Compensation

### General notes

This feature allows the easYgen to adapt the phase angle measurement system according to the transformer type. The phase angle of the "generator to busbar" and the "busbar to mains" measurement can be compensated. The phase angle compensation is activated with the parameters "Phase angle compensation GCB" (parameter 8825 p. 229) and "Phase angle compensation MCB" (parameter 8841 p. 231).

The controller provides an adjustment for a phase angle deviation in a range of  $\pm 180.0^\circ$ . The range can be configured with the parameters "Phase angle GCB" (parameter 8824 p. 229) and "Phase angle MCB" (parameter 8842 p. 232). These parameters compensate the phase angle deviation, which can be caused by transformers (i.e. a delta to wye transformer) located within the electrical system.

**Example – phase angle compensation GCB**

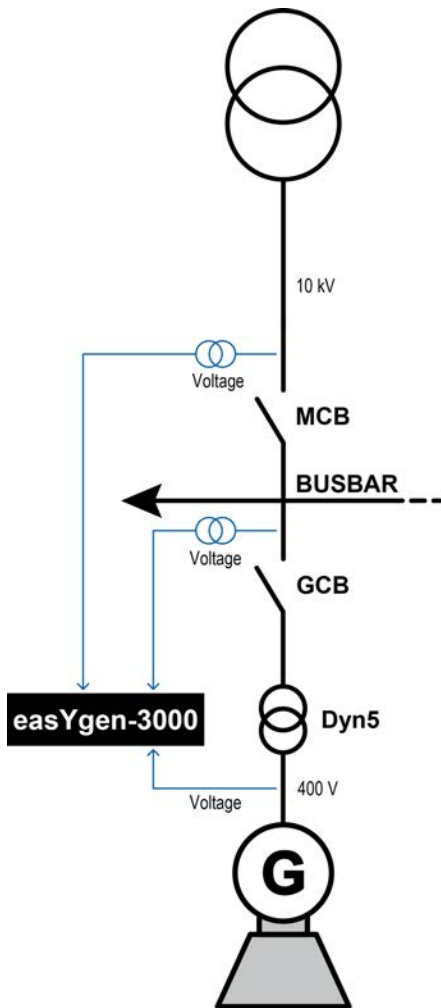

Fig. 222: Phase angle compensation GCB

The easYgen generator voltage is connected to the low voltage side of a transformer with the vector group **Dyn5**. The easYgen busbar voltage is connected to the high voltage side. Because of the transformer, the phase angles between generator and busbar differs due the closed GCB. The synchronization function of the easYgen can be compensated by a configurable phase angle deviation.

Using vector group 5 (Dyn5) implies:  $\alpha = 5 \times 30^\circ = 150^\circ$ . Since  $150^\circ < 180^\circ$  and the easYgen busbar measurement is connected to the high voltage side, this results into "α" to be used as phase difference. Configure parameter "Phase angle GCB" (parameter 8824 ↪ p. 229) to "150°" to compensate the phase difference between generator/busbar.

### Example – phase angle compensation MCB

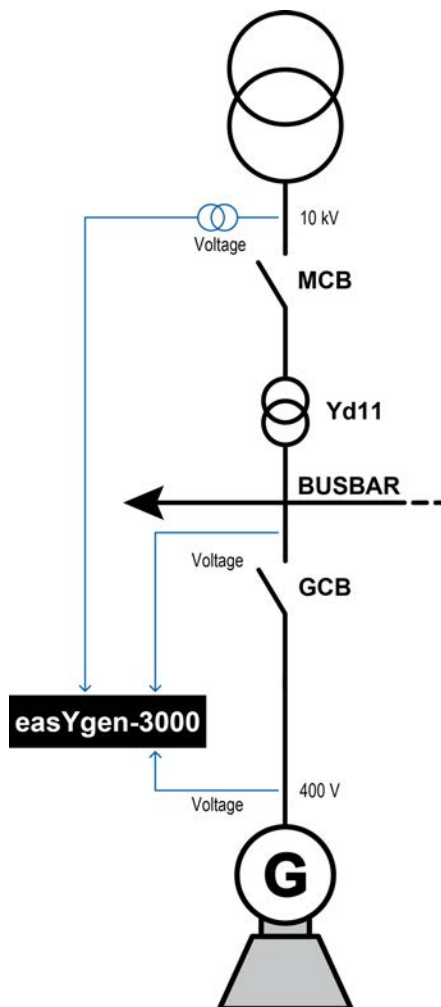

Fig. 223: Phase angle compensation MCB

The easYgen mains voltage is connected to the high voltage side of a transformer with the vector group **Yd11**. The easYgen busbar voltage is connected to the low voltage side. Because of the transformer, the phase angles between mains and busbar differs due the closed MCB. The synchronization function of the easYgen can be compensated by a configurable phase angle deviation.

Using vector group 11 (Yd11) implies:  $\alpha = 11 \times 30^\circ = 330^\circ$ . Since  $330^\circ > 180^\circ$  and the easYgen mains measurement is connected to the high voltage side, this results into  $-360^\circ - \alpha$  to be used as phase difference. Configure parameter "Phase angle MCB" (parameter 8842 ↪ p. 232) to  $-30^\circ$  to compensate the phase difference between mains/busbar.

#### 6.4.14 Start/Stop Logic Mode "Off"

##### General notes

The start/stop sequence in the easYgen is completely disabled. This function is needed in applications where the control of the start/stop logic is completely done by an external device (e.g. PLC).



The LogicsManager "Firing speed" (parameter 12500 ↪ p. 270) has a special function, if the "Start/stop logic mode" (parameter 3321 ↪ p. 260) is configured to "Off". When the LogicsManager becomes TRUE, the delayed monitoring function alarms are triggered, which are delayed by the engine speed. If they become FALSE all engine speed related monitoring functions are switched off. The LogicsManager "Start req. in AUTO" (parameter 12120 ↪ p. 279) gets a special function if the "Start/stop logic mode" (parameter 3321 ↪ p. 260) is configured to "Off". When the LogicsManager becomes TRUE the operational mode begins. With becoming FALSE the operational mode will be left.

To operate the easYgen in this configuration correctly, the following needs to be done:

- The easYgen requires an external feedback, that the drive system will be started. That is the precondition for the easYgen to trigger the delayed monitoring function, which activates, after a delay time, the speed related monitoring functions. (under-speed, underfrequency, undervoltage, etc.)
- The easYgen requires an external feedback, that the drive system will be stopped. That is the precondition for the easYgen to deactivate the speed related monitoring functions. This avoids upcoming alarms due the drive system is stopped.
- The easYgen must be directed to switch into the active operational mode or to exit this operational mode. The operational mode proceeds with the actions according to the configured application and transition modes.

## Example

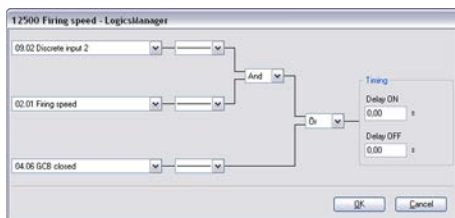

Fig. 224: LogicsManager function "Firing speed"

The following section shows a practical example, to explain in detail the described above configuration.

Fig. 224 shows the LogicsManager "Firing speed" (parameter 12500 ↵ p. 270). The LogicsManager must be configured as follows:

- The external start/stop device gives an feedback to the easYgen via discrete input [DI 02] ("09.02 Discrete input 2") that the drive system will be started or already is started.
- When simultaneously the firing speed ("02.01 Firing speed") is reached, the equation becomes TRUE and the delayed monitoring function will be triggered.
- For security reasons a closed GCB ("04.06 GCB closed") forces the monitoring too.

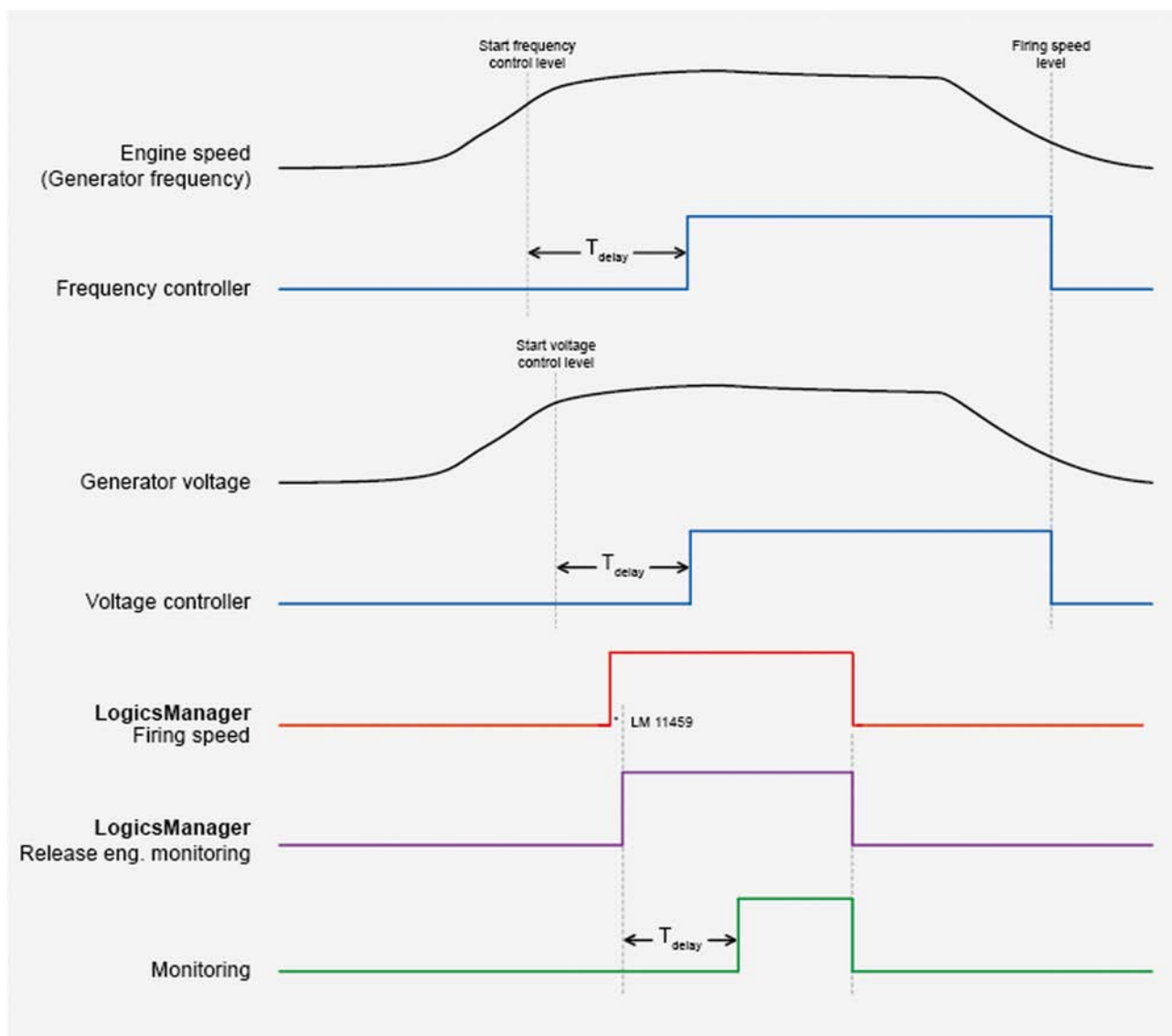

Fig. 225: Start/Stop sequence - LogicsManager "Firing speed"

Drawing above shows the following:

- The frequency controller is triggered, if the engine speed (generator frequency) reaches the "Start frequency control level" (parameter 5516 ↪ p. 306) and after the expired "Start frequency control delay" (parameter 5517 ↪ p. 307) time. The frequency controller is switched off, if the engine speed (generator frequency) falls below the "Firing speed" (parameter 12500 ↪ p. 270) level.
- The voltage controller is triggered, if the generator reaches the "Start value" (parameter 5616 ↪ p. 326) and after the expired "Start delay" (parameter 5617 ↪ p. 326) time. The voltage controller is switched off, if the engine speed (generator frequency) falls below the "Firing speed" (parameter 12500 ↪ p. 270) level.
- The delayed monitoring function is triggered when LogicsManager "Release engine monitoring" (parameter 12999 ↪ p. 272) becomes TRUE and after the "Engine monitoring delay time" (parameter 3315 ↪ p. 270). The delayed monitoring function is switched off when LogicsManager "Release engine monitoring" (parameter 12999 ↪ p. 272) becomes FALSE.

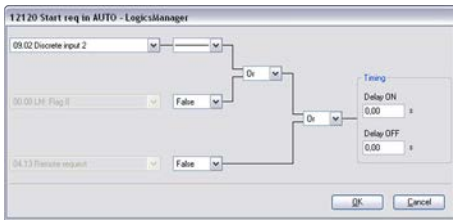

Fig. 226: LogicsManager function "Start req. in AUTO"

To activate the operational mode in the easYgen, discrete input [DI 02] ("09.02 Discrete input 2") is used in the LogicsManager "Start req. in AUTO" (parameter 12120 ↪ p. 279) .

With removing the start request in AUTOMATIC the operational mode will be left.

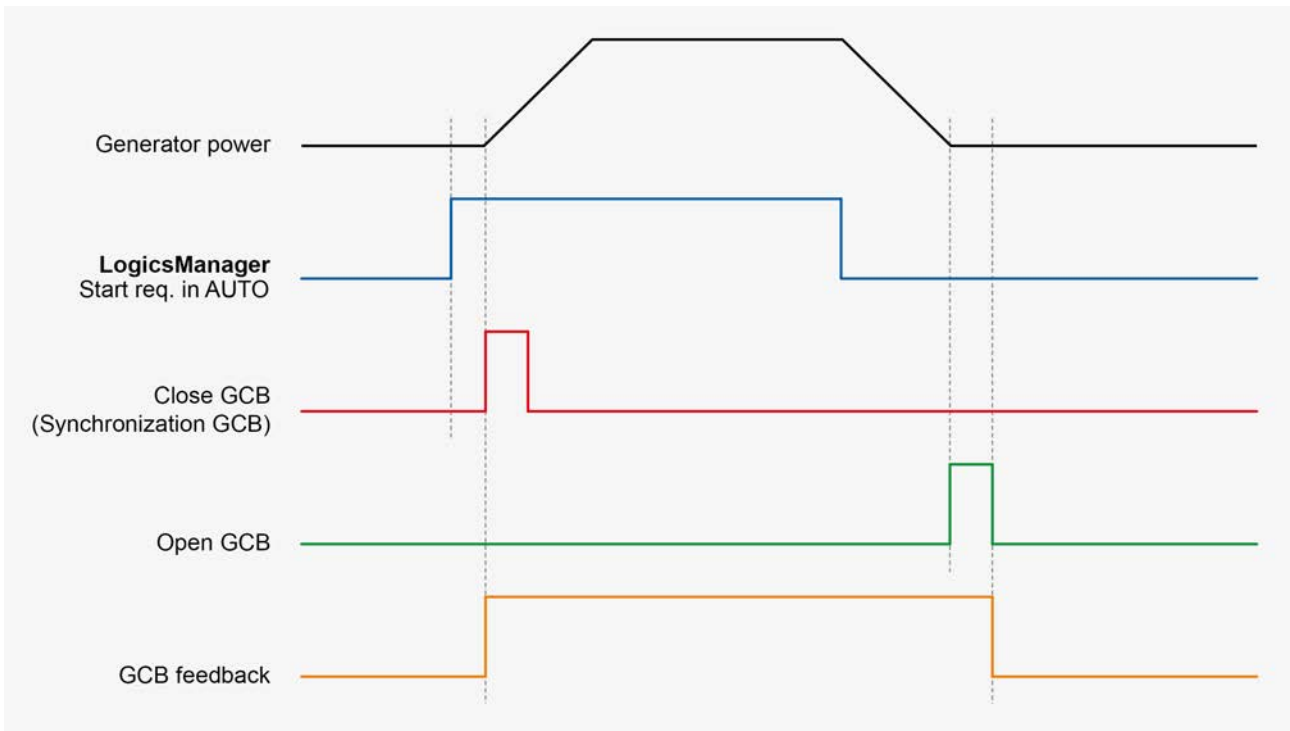

Fig. 227: Start/Stop sequence - LogicsManager "Start req. in AUTO"

Fig. 227 shows the following:

- The closing (synchronization) of the GCB is triggered when LogicsManager "Start req. in AUTO" (parameter 12120 ↪ p. 279) becomes TRUE.
- The opening (including power down ramping) of the GCB is triggered when LogicsManager "Start req. in AUTO" (parameter 12120 ↪ p. 279) becomes FALSE.

### 6.4.15 Ripple Control Receiver

#### General notes

Decentralised energy producers can be obliged by power supply companies to equip plants with a technical and operational provision for remote-controlled reduction of the feed-in power to stabilize mains. Ripple control is one form of power limitation and is used in many countries around the world.

#### Functionality

The energy supply company provides a signal to the ripple control receiver to reduce the feed-in power of the generating plant. The ripple control receiver switches four relay contacts according to the required energy power level. This relay contacts correspond for example to the following energy power levels:

- 100 % (full feed-in) - Step 1
- 60 % - Step 2
- 30 % - Step 3
- 0 % (no feed-in) - Step 4

The respective contact is closed for the duration of the reduction.

The reduction of the feed-in power must be established within a certain time frame (depending on national regulations).

**Derating of power**

The power reduction is realized by using the LogicsManager "Free derating" (parameter 15146 ↪ p. 320). This function is using an analog signal. For this reason the relay outputs of the ripple control receiver must be converted into a corresponding analog signal. We recommend a resistor array like shown in Fig. 228 to convert the relay outputs into a analog signal (0 to 500 Ohms).

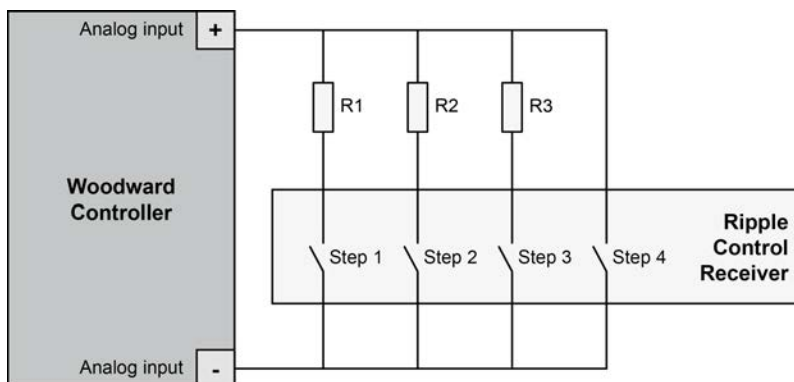

Fig. 228: Ripple control receiver wiring

- R1 = 500 Ohms (or 560 parallel 4.7 k)
- R2 = 300 Ohms (or 330 parallel 3.3 k)
- R3 = 150 Ohms

Max. power [% of rated]	Switched relay ripple control receiver	Corresponding analog value	Derating [% of rated]
100 %	Relay - Step 1	500 Ohms	0 %
60 %	Relay - Step 2	300 Ohms	40 %
30 %	Relay - Step 3	150 Ohms	70 %
0 %	Relay - Step 4	0 Ohms	1000 %

**Configuring the analog input for a ripple control receiver**

1. ➤ Either on the front panel or using ToolKit navigate to menu “Configure analog inputs ➔ Analog input 1”.
2. ➤ Configure the parameters listed below.

ID	Parameter	Value	Comment
1000	Type	Linear	A user-defined linear characteristic curve is to be used
1001	User defined min display value	+00000	A value of 000.00 % is displayed at the minimum of the input range
1002	User defined max display value	+01000	A value of 100.00 % is displayed at the maximum of the input range
1039	Sender value at display min.	000.00 %	The sender value at minimum display is 0 % i.e. 0 Ohms
1040	Sender value at display max.	100.00 %	The sender value at maximum display is 100 % i.e. 500 Ohms
1020	Sender type	0 - 500 Ohm	A 0 to 500 Ohms sender is used on the analog input
10113	Filter time constant	3	Filter time depending on the ambient conditions
3632	Bargraph minimum	+00000	The start value for the bargraph display of the analog input is 00000
3633	Bargraph maximum	+01000	The end value for the bargraph display of the analog input is 01000

3. ➤ Configure the following parameters using ToolKit. They facilitate a more detailed display of the analog value.

ID	Parameter	Value	Comment
1025	Description	Analog inp. 1	Analog input [AI 01] is labeled with "Analog inp.1" on the display
1035	Value format	000.00 %	The value format of the bargraph display of the analog input is "000.00 %"

**Configuring the derating of power**

1. ➤ Either on the front panel or using ToolKit navigate to menu “Configure load control ➔ Derating of power”.
2. ➤ Configure the parameters listed below.

ID	Parameter	Value	Comment
15143	Start derating at	+01000	The starting point when the derating becomes active
15144	Stop derating at	+00000	Defines (in combination with parameter 15143 ↪ p. 320) the ramp of the derating function
15145	Max. power deviation	100.0 %	The maximal power deviation of the derating function
15147	Source free derating	06.01 Analog input 1	Defines the analog source which controls the derating function
15142	J1939 derating	Off	The derate command via ECU is ignored



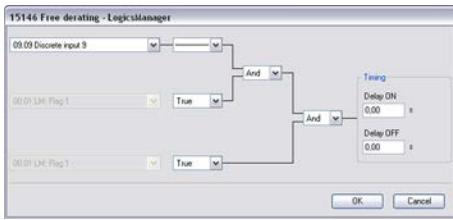

Fig. 229: LogicsManager function "Free derating"

- Configure the LogicsManager function "Free derating" as shown in ( Fig. 229) to enable derating of power if discrete input [DI 09] is energized.



Please configure "Alarm class" (parameter 1362 p. 248) of discrete input [DI 09] to "Control".

### Maximal power setpoint

After the unit is configured as described above, the maximal power setpoint looks like shown in Fig. 230.

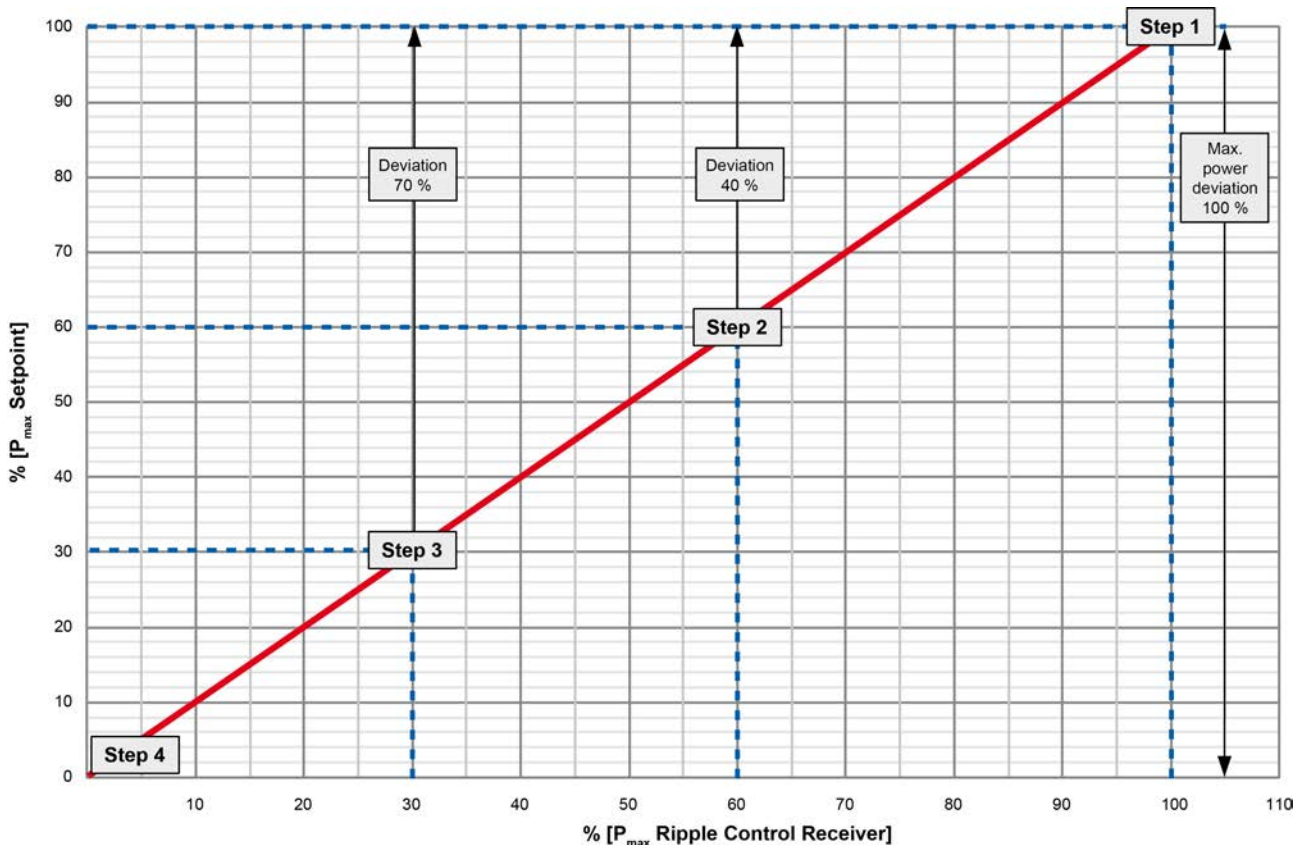

Fig. 230: Maximal power setpoint

## 6.4.16 Neutral Interlocking

### General Notes

The Neutral Interlocking function controls in multiple-gen applications the Neutral Contactor (NC) of each generator. The contactor bridges the Neutral with the PE. The rule is that only one neutral of the running generators in the same segment are bridged to earth.

The Logic ensures that with changing of generators or a lacking neutral breaker the neutral link is passed over to another active running generator. This requires information exchange between the genset controls. The load share protocol in the easYgen provides the according information.

Application Examples

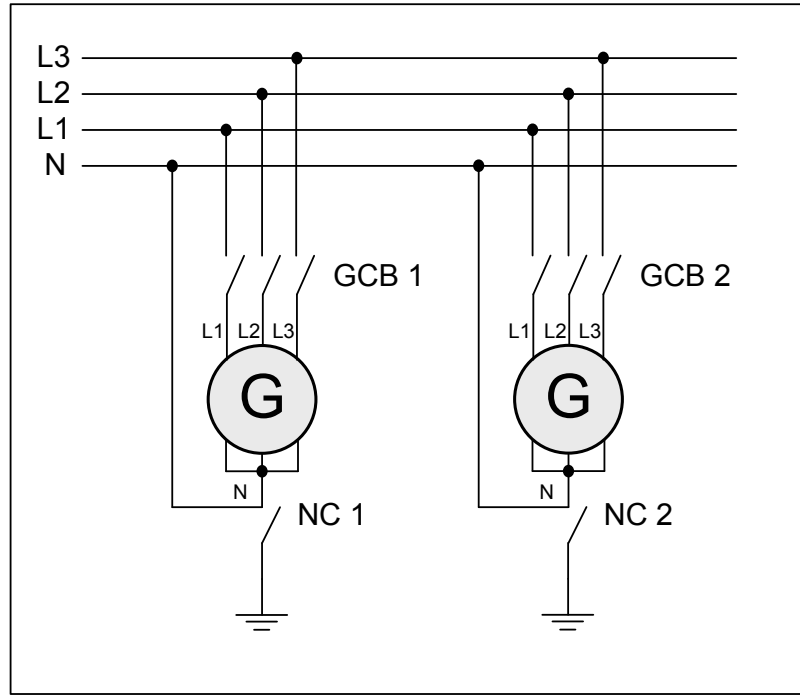

Fig. 231: Wiring neutral Interlocking: GCB 3-pole

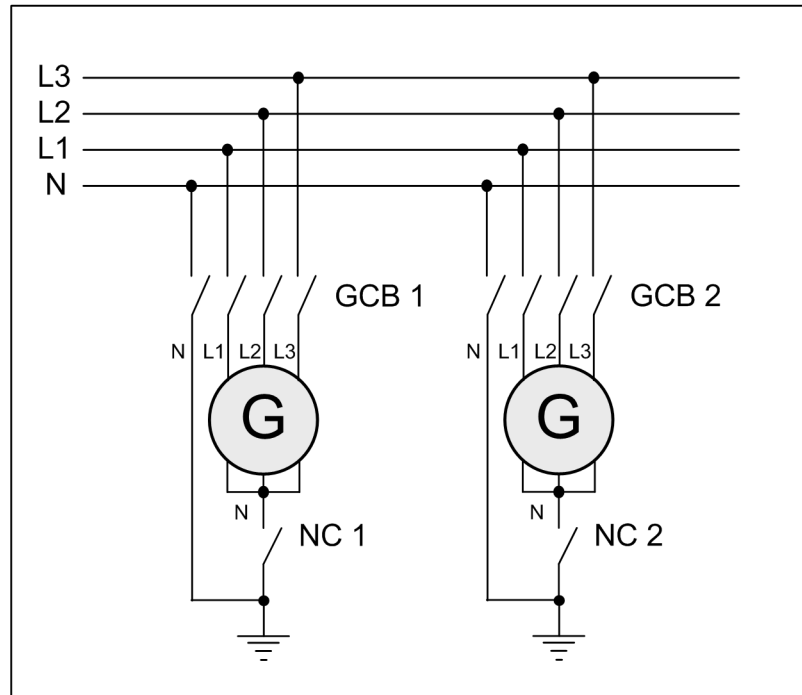

Fig. 232: Wiring neutral Interlocking: GCB 4-pole

Function

Start and operating

The genset control closes principally after each successful start (firing speed reached) the NC. The genset control proceeds with closing the GCB, if the NC has been closed successfully. If the NC closure was not successful the easYgen issues an alarm. The NC and GCB closure procedure is blocked from now on, until the alarm is acknowledged.

When the GCB is closed the genset control begins to figure out, whether the own NC can remain closed or must be opened. This monitoring is done continuously.

As long the GCB is closed, the NC remains closed or is closed, if:

- No connection to mains is active

**AND**

- one of the following is TRUE

- the own NC is the only closed NC in the same segment

**OR**

- there is minimum one other NC in the same segment closed but the own generator has a higher neutral interlocking priority

**OR**

- there is minimum one other NC in the same segment closed which has the same neutral interlocking priority but the own genset control has a lower device number

In all other cases the NC is opened!

### Running Generator without closed GCB

As long the engine/generator is running and the GCB is open the NC will be closed or remains closed until the engine/generator is stopped.

### Neutral Contactor (NC) Feedback

The discrete input 12 (DI 12) is used as feedback of the Neutral contactor and cannot be configured onto another discrete input. If the input is energized, the neutral contactor is recognized as closed.

### Monitoring NC Feedback

The monitoring of the NC feedback is performed always, if the Neutral Interlocking is enabled. The monitor checks, if the feedback behaves according to the NC command. With a configurable delay time the alarm is activated with a general alarm text. Open or closure failure are not differentiated. The issued Alarm text is: "N-cont. reply mism." (Neutral contactor has a reply mismatch).

### Event logger and NC Feedback

If the Neutral Interlocking is enabled, following event entries shall take place:

- Neutral cont. opened (with +)
- Neutral cont. closed (with +)

### Priority for Closing NC

The priority for closing GCB is configurable. This priority is independent from the LDSS priority. The customer can freely decide which generator shall get which priority.



The advantage of this determination is that the application is not fixed with rated power settings. Maybe there are other circumstances which shall determine the neutral interlocking priority.

Two LogicsManager variables give further information:

- 03.39 Close neutral contactor - status
- 08.37 Neutral contactor reply mismatch

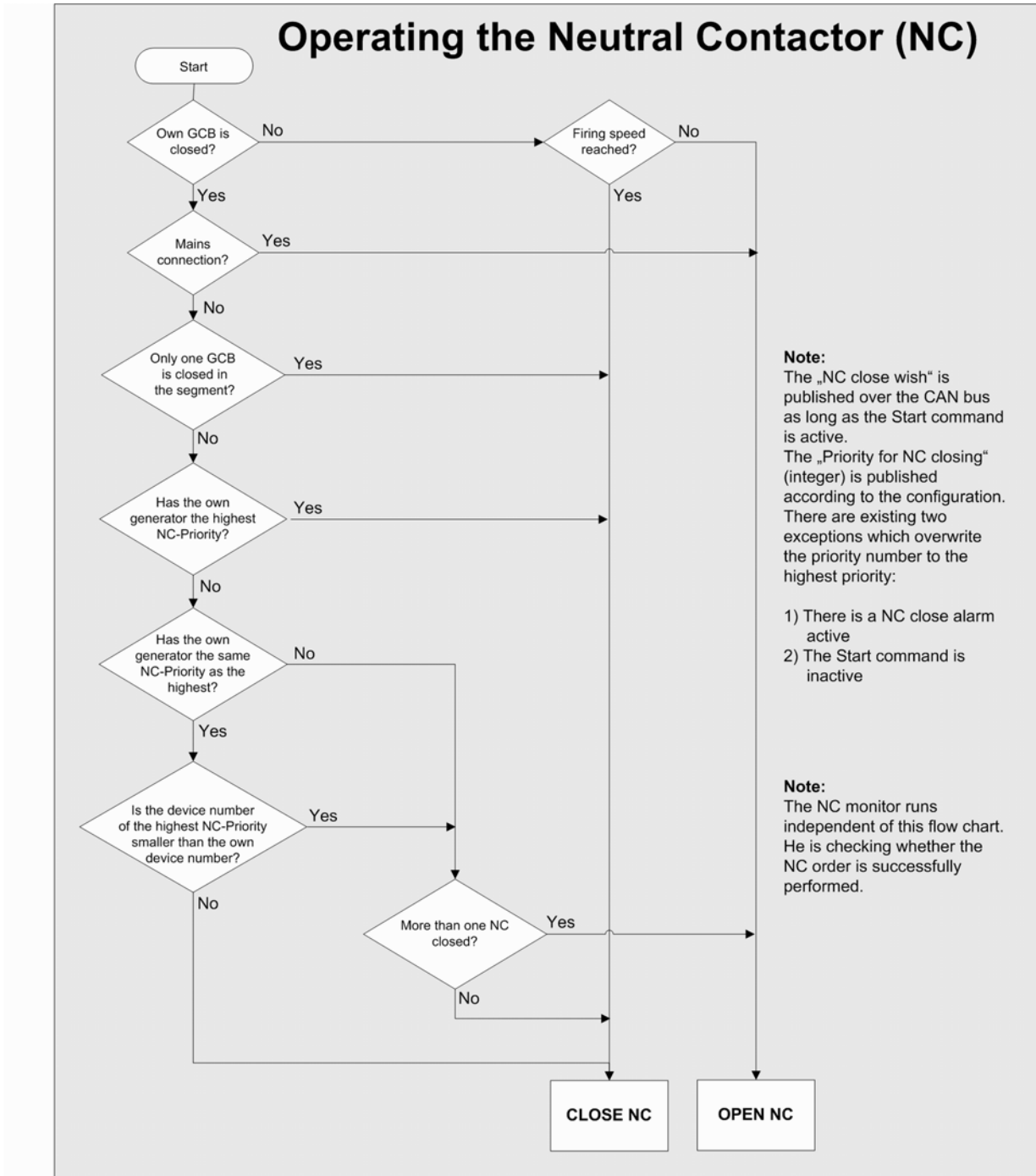

Fig. 233: FlowChart\_Neutral-Interlocking

## 6.5 CANopen Applications

### 6.5.1 Remote Control

#### 6.5.1.1 Remote Start/Stop, Shutdown, And Acknowledgement



Refer to [Chapter 6.4.5](#) "Performing Remote Start/Stop And Acknowledgement" on page 436 for detailed information.

The easYgen may start, stop, shut down, or acknowledge alarms with CAN/Modbus. Therefore, two logical command variables (04.13 and 04.14) have to be configured with the LogicsManager. 03.40 can handle Remote shutdown only.

- 04.13 Remote request
- 04.14 Remote acknowledge
- 03.40 Remote shutdown

A Remote Shutdown 03.40 can be configured via LogicsManager internal flag (e.g. 12230 Flag 1) combined with a free alarm LogicsManager (e.g. Free alarm 1) configured with shutdown alarm class.

Two different methods to perform a remote start/stop/acknowledgement using 04.13 Remote request and 04.14 Remote acknowledge are detailed in the below.

These are "Remote start/stop/acknowledgement via RPDO" and "Remote start/stop/acknowledgement via default SDO communication channel". The advantages and the disadvantages of these two methods are as follows.

RPDO	Default SDO communication channel
Classical communication for CANopen devices	Configuration process
One message	Two messages
No validation of the received answer	Validation answer, if message has been received by the unit
Only working in operational mode	May take longer in case of communication with two messages

Table 78: Comparison

#### 6.5.1.1.1 RPDO

##### Configure CAN interface 1

CANopen Master (parameter 8993 [p. 353](#)) must be enabled, if there is no PLC taking over the master function.

1. Either on the front panel or using ToolKit navigate to menu "Configure CAN interface → Configure CAN interface 1".
2. Configure the parameter listed below.

ID	Parameter	Value	Comment
8993	CANopen Master	On	CANopen Master is enabled.

### Configure RPDO

1. ➤ Either on the front panel or using ToolKit navigate to menu “Configure CAN interface 1 ➔ Receive PDO 1”.
2. ➤ Configure the parameters listed below.

ID	Parameter	Value	Comment
9300	COB-ID	00000201 (hex)	COB-ID set to 00000201.
9910	Number of Mapped Objects	1	One mapped object is configured
9911	1. Mapped Object	00503	The 1st mapped object is set to control parameter 503.



*Setting the COB-ID to 201 (hex) is exemplary; usually, the PDOs are in the range of 181 (hex) to 57F (hex).*

With this setting, the Receive PDO is set to the address, for which the device is listening on the bus. The number of mapped objects is 1 since 1 mapped object is used. The request on the bus is sent with the control parameter 503 of the device as mapped object 1.



*Refer to ↗ Chapter 9.2.4 “Additional Data Identifier” on page 663 for a list of additional parameter groups.*

### CANopen message

The following table shows a exemplary request data for the device on the CANopen bus. The data (hex) shows the state of parameter 503 to achieve the required control.

ID (hex)	Description	Data (hex)
201	Remote Start	01 00
201	Remote Stop	02 00
201	Remote Acknowledge	10 00
201	Remote Shutdown	00 02

#### 6.5.1.1.2 Default SDO Communication Channel

Another possibility for a remote start/stop/acknowledgement is to send the request via default SDO communication channel. The device listens to the CAN ID 600 (hex) + Node-ID internally to perform the desired control, the reply is on CAN ID 580 (hex) + Node-ID.

The following examples show the request format on CANopen with different Node-IDs.

The request on the bus is sent via the control parameter ID 503 of the device.

The value 2000 (hex) is calculated internally:

- 503 (dec) -- 1F7 (hex)
- 1F7+2000 (hex) = 21F7 (hex)



*Please note that high and low bytes are exchanged in the sent address. The data (hex) shows the state of parameter 503 to achieve the required control.*

### Node-ID 1 (standard value)

The following table shows exemplary request data for the device on the CANopen bus.

Identifier	Description	Data
601	Remote Start	2B F7 21 01 01 00 00 00
601	Remote Stop	2B F7 21 01 02 00 00 00
601	Remote Acknowledge	2B F7 21 01 10 00 00 00
601	Remote Shutdwon	2B F7 21 01 00 02 00 00

### Node-ID (not standard value)

If the Node-ID of the device is intended to be different from the standard value, the parameter "Node-ID CAN bus 1" (parameter 8950 ↗ p. 353) must be configured accordingly. Node-ID 2 is used in the following example.

1. ➤ Either on the front panel or using ToolKit navigate to menu "Configure CAN interface → Configure CAN interface 1".
2. ➤ Configure the parameter listed below.

ID	Parameter	Value	Comment
8950	Node-ID CAN bus 1	002	Node-ID set to 002.

⇒ With this setting, the Node-ID of the CAN interface 1 is set to 002.

The request on the bus is sent via the control parameter 503 of the device.

The hexadecimal value 2000 is calculated internally:

- 503 (dec) -- 1F7 (hex)
- 1F7 (hex) + 2000 (hex) = 21F7 (hex)



*Please note that high and low bytes are exchanged in the sent address.*



The data (hex) shows the state of parameter 503 to achieve the required control.

The following table shows exemplary request data for the device on the CANopen bus.

Identifier	Description	Data
602	Remote Start	2B F7 21 01 01 00 00 00
602	Remote Stop	2B F7 21 01 02 00 00 00
602	Remote Acknowledge	2B F7 21 01 10 00 00 00
602	Remote Shutdown	2B F7 21 01 00 02 00 00

## Additional SDO communication channels

It is also possible to allow several PLCs to start/stop/acknowledge the unit in addition to the default SDO communication channel. Four additional SDO communication channels are provided for this. The additional SDO 127 (dec) is used in the following example.

1.  Either on the front panel or using ToolKit navigate to menu "Configure CAN interface 1 → Additional Server SDOs".
2.  Configure the parameters listed below.

ID	Parameter	Value	Comment
33040	2. Node-ID	127 (dec) = 7F (hex)	SDO communication channel is configured to 127

⇒ With this setting, an additional SDO communication channel is configured to 127.

The control request is equal to the request via default SDO communication channel, but the device will listen to messages including the configured address as well.

The device listens to the CAN ID 600 (hex) + 2. Node-ID internally to perform the desired control, the reply from the easYgen is sent on CAN ID 580 (hex) + 2. Node-ID.

- Receive CAN ID 67F (hex) (600 (hex) + 7F (hex))
- Receive CAN ID 5FF (hex) (580 (hex) + 7F (hex))

The same is valid for the additional SDO communication channels 3, 4, and 5.

The following table shows exemplary request data for the device on the CANopen bus.

Identifier	Description	Data
67F	Remote Start	2B F7 21 01 01 00 00 00
67F	Remote Stop	2B F7 21 01 02 00 00 00
67F	Remote Acknowledge	2B F7 21 01 10 00 00 00
67F	Remote Shutdown	2B F7 21 01 00 02 00 00



*If parameters are written or read via two or more SDO communication channels at the same time (before the first has answered), the second one will be refused.*



### 6.5.1.2 Transmitting A Frequency Setpoint

It is possible to transmit a frequency setpoint value via the CANopen protocol. Prerequisite for the use of a frequency setpoint via an interface is the configuration of the frequency setpoint source (parameter 5518 ↪ p. 305 for frequency setpoint 1 source or parameter 5519 ↪ p. 306 for frequency setpoint 2 source). Refer to ↪ Chapter 4.5.12.1 "Frequency Control" on page 302 for detailed information.

The respective frequency setpoint source is to be configured to 05.03 "Interface freq.setp".

Two different methods to transmit a frequency setpoint via CANopen are detailed below.

These are "Transmitting a frequency setpoint via RPDO" and "Transmitting a frequency setpoint via default SDO communication channel". The advantages and the disadvantages of these two methods are as follows.

RPDO	Default SDO communication channel
Classical communication for CANopen devices	Configuration process
One message	Two messages
No validation of the received answer	Validation answer, if message has been received by the unit
Only working in operational mode	May take longer in case of communication with two messages

Table 79: Comparison

#### 6.5.1.2.1 RPDO

##### Configure CAN interface 1

CANopen Master (parameter 8993 ↪ p. 353) must be enabled, if there is no PLC taking over the master function.

1. ↪ Either on the front panel or using ToolKit navigate to menu "Configure CAN interface → Configure CAN interface 1".
2. ↪ Configure the parameter listed below.

ID	Parameter	Value	Comment
8993	CANopen Master	On	CANopen Master is enabled.

### Configure RPDO

1. ➤ Either on the front panel or using ToolKit navigate to menu "Configure CAN interface 1 ➔ Receive PDO 1".
2. ➤ Configure the parameters listed below.

ID	Parameter	Value	Comment
9300	COB-ID	00000321 (hex)	COB-ID set to 00000321.
9910	Number of Mapped Objects	1	One mapped object is configured
9911	1. Mapped Object	00509	The 1st mapped object is set to control parameter 509.



*Setting the COB-ID to 321 (hex) is exemplary; usually, the PDOs are in the range of 181 (hex) to 57F (hex).*

With this setting, the Receive PDO is set to the address, for which the device is listening on the bus. The number of mapped objects is 1 since 1 mapped object is used. The request on the bus is sent with the control parameter 509 of the device as mapped object 1.



*Refer to ↗ Chapter 9.2.4 "Additional Data Identifier" on page 663 for a list of additional parameter groups.*

### CANopen message

The following table shows exemplary send data for the device on the CANopen bus.

A frequency setpoint of 50.60 Hz is transmitted:

- 5060 (dec) = 13C4 (hex) → C4 13 according to the CANopen protocol

ID (hex)	Description	Data (hex)
321	Remote F setpoint	C4 13

#### 6.5.1.2.2 Default SDO Communication Channel

Another possibility for transmitting a frequency setpoint is to send the value via default SDO communication channel. The device listens to the CAN ID 600 (hex) + Node-ID internally to perform the desired control, the reply is on CAN ID 580 (hex) + Node-ID.

The following example shows the send format on CANopen with Node-ID 1.

The value is sent on the bus via the control parameter 509 of the device.

The hexadecimal value 2000 is calculated internally:

- 509 (dec) -- 1FD (hex)
- 1FD (hex) + 2000 (hex) = 21FD (hex)



Please note that high and low bytes are exchanged in the sent value.

The data (hex) shows the state of parameter 509 to achieve the required control.

The following table shows exemplary send data for the device on the CANopen bus.

Identifier	Description	Data
601	Remote F setpoint	2B FD 21 01 C4 13 00 00

### 6.5.1.3 Transmitting A Voltage Setpoint

It is possible to transmit a voltage setpoint value via the CANopen protocol. Prerequisite for the use of a voltage setpoint via an interface is the configuration of the voltage setpoint source (parameter 5618 ↗ p. 325 for voltage setpoint 1 source or parameter 5619 ↗ p. 325 for voltage setpoint 2 source).

Refer to ↗ *Chapter 4.5.12.5 "Voltage Control" on page 323* for detailed information.

The respective voltage setpoint source is to be configured to 05.09 "Interface volt.setp".

Two different methods to transmit a voltage setpoint setpoint via CANopen are detailed below.

These are "Transmitting a voltage setpoint via RPDO" and "Transmitting a voltage setpoint via default SDO communication channel". The advantages and the disadvantages of these two methods are as follows.

RPDO	Default SDO communication channel
Classical communication for CANopen devices	Configuration process
One message	Two messages
No validation of the received answer	Validation answer, if message has been received by the unit
Only working in operational mode	May take longer in case of communication with two messages

Table 80: Comparison

#### 6.5.1.3.1 RPDO

##### Configure CAN interface 1

CANopen Master (parameter 8993 ↗ p. 353) must be enabled, if there is no PLC taking over the master function.

1. ➤ Either on the front panel or using ToolKit navigate to menu "Configure CAN interface ➔ Configure CAN interface 1".
2. ➤ Configure the parameter listed below.

ID	Parameter	Value	Comment
8993	CANopen Master	On	CANopen Master is enabled.

## Configure RPDO

1. ➤ Either on the front panel or using ToolKit navigate to menu "Configure CAN interface 1 ➔ Receive PDO 1".
2. ➤ Configure the parameters listed below.

ID	Parameter	Value	Comment
9300	COB-ID	00000321 (hex)	COB-ID set to 00000321.
9910	Number of Mapped Objects	1	One mapped object is configured
9911	1. Mapped Object	00510	The 1st mapped object is set to control parameter 510.



*Setting the COB-ID to 321 (hex) is exemplary; usually, the PDOs are in the range of 181 (hex) to 57F (hex).*

With this setting, the Receive PDO is set to the address, for which the device is listening on the bus. The number of mapped objects is 1 since 1 mapped object is used. The request on the bus is sent with the control parameter 510 of the device as mapped object 1.



*Refer to ↗ Chapter 9.2.4 "Additional Data Identifier" on page 663 for a list of additional parameter groups.*

## CANopen message

The following table shows exemplary send data for the device on the CANopen bus in line 1.

A voltage setpoint of 412 V is transmitted:

- 412 (dec) = 019C (hex) → 9C 01 according to the CANopen protocol

ID (hex)	Description	Data (hex)
321	Remote V setpoint	9C 01 00 00

### 6.5.1.3.2 Default SDO Communication Channel

Another possibility for transmitting a voltage setpoint is to send the value via default SDO communication channel. The device listens to the CAN ID 600 (hex) + Node ID internally to perform the desired control, the reply is on CAN ID 580 (hex) + Node ID.

The following example shows the send format on CANopen with Node ID 1.

The value is sent on the bus via the control parameter 510 of the device.

The hexadecimal value 2000 is calculated internally:

- 510 (dec) - 1FE (hex)
- 1FE (hex) + 2000 (hex) = 21FE (hex)



*Please note that high and low bytes are exchanged in the sent value.*

ID (hex)	Description	Data (hex)
601	Remote V setpoint	23 FE 21 01 9C 01 00 00

The data (hex) shows the state of parameter 510 to achieve the required control.

The above table shows exemplary send data for the device on the CANopen bus in line 2.

### 6.5.1.4 Transmitting A Power Factor Setpoint

It is possible to transmit a power factor setpoint value via the CANopen protocol. Prerequisite for the use of a power factor setpoint via an interface is the configuration of the power factor setpoint source (parameter 5638 ↗ p. 331 for power factor setpoint 1 source or parameter 5639 ↗ p. 331 for power factor setpoint 2 source)

Refer to ↗ *Chapter 4.5.12.6 "Power Factor Control" on page 327* for detailed information.

The respective power factor setpoint source is to be configured to 05.12 "Interface PF setp."

Two different methods to transmit a power factor setpoint via CANopen are detailed below.

These are "Transmitting a power factor setpoint via RPDO" and "Transmitting a power factor setpoint via default SDO communication channel". The advantages and the disadvantages of these two methods are as follows.

RPDO	Default SDO communication channel
Classical communication for CANopen devices	Configuration process
One message	Two messages

RPDO	Default SDO communication channel
No validation of the received answer	Validation answer, if message has been received by the unit
Only working in operational mode	May take longer in case of communication with two messages

Table 81: Comparison

### 6.5.1.4.1 RPDO

#### Configure CAN interface 1

CANopen Master (parameter 8993 ↗ p. 353) must be enabled, if there is no PLC taking over the master function.

1. ➤ Either on the front panel or using ToolKit navigate to menu “Configure CAN interface ➔ Configure CAN interface 1”.
2. ➤ Configure the parameter listed below.

ID	Parameter	Value	Comment
8993	CANopen Master	On	CANopen Master is enabled.

#### Configure RPDO

1. ➤ Either on the front panel or using ToolKit navigate to menu “Configure CAN interface 1 ➔ Receive PDO 1”.
2. ➤ Configure the parameters listed below.

ID	Parameter	Value	Comment
9300	COB-ID	00000321 (hex)	COB-ID set to 00000321.
9910	Number of Mapped Objects	1	One mapped object is configured
9911	1. Mapped Object	00508	The 1st mapped object is set to control parameter 508.



Setting the COB-ID to 321 (hex) is exemplary; usually, the PDOs are in the range of 181 (hex) to 57F (hex).

With this setting, the Receive PDO is set to the address, for which the device is listening on the bus. The number of mapped objects is 1 since 1 mapped object is used. The request on the bus is sent with the control parameter 508 of the device as mapped object 1.



Refer to ↗ Chapter 9.2.4 “Additional Data Identifier” on page 663 for a list of additional parameter groups.

**CANopen message**

The following table shows exemplary send data for the device on the CANopen bus. A power factor setpoint of 0.85 capacitive/leading is transmitted (64689 (dec) [65536-850] = FCAE (hex) → AE FC according to the CANopen protocol) in line 1. Please note that negative (capacitive or leading) power factor values are deducted from 65536 (dec) or FFFF (hex).

A power factor setpoint of 0.9 inductive/lagging is transmitted in line 2:

- 900 (dec) = 0384 (hex) → 84 03 according to the CANopen protocol.

A power factor setpoint of 1.0 is transmitted in line 3:

- 1000 (dec) = 03E8 (hex) → E8 03 according to the CANopen protocol

ID (hex)	Description	Data (hex)
321	Remote PF Ld 085	AE FC
321	Remote PF LG 090	84 03
321	Remote PF 1.00	E8 03

**6.5.1.4.2 Default SDO Communication Channel**

Another possibility for transmitting a power factor setpoint is to send the value via default SDO communication channel. The device listens to the CAN ID 600 (hex) + Node-ID internally to perform the desired control, the reply is on CAN ID 580 (hex) + Node-ID.

The following example shows the send format on CANopen with Node-ID 1.

The value is sent on the bus via the control parameter 508 of the device.

The hexadecimal value 2000 is calculated internally:

- 508 (dec) -- 1FC (hex)
- 1FC (hex) + 2000 (hex) = 21FC (hex)



*Please note that high and low bytes are exchanged in the sent value.*

The data (hex) shows the state of parameter 508 to achieve the required control.

The following table shows exemplary send data for the device on the CANopen bus.

Identifier	Description	Data
601	Remote PF Ld 085	2B FC 21 01 AE FC
601	Remote PF LG 090	2B FC 21 01 84 03
601	Remote PF 1.00	2B FC 21 01 E8 03

### 6.5.1.5 Transmitting A Power Setpoint

It is possible to transmit a power setpoint value via the CANopen protocol. Prerequisite for the use of a power setpoint via an interface is the configuration of the power setpoint source (parameter 5539 ↪ p. 310 for power setpoint 1 source or parameter 5540 ↪ p. 311 for power setpoint 2 source).

Refer to ↪ *Chapter 4.5.12.2 "Load Control" on page 308* for detailed information).

The respective power setpoint source is to be configured to 05.06 "Interface pow. setp."



*Please note that the type of the power setpoint (Constant, Import, or Export) must also be defined (parameter 5526 ↪ p. 311 for load setpoint 1 or parameter 5527 ↪ p. 312 for load setpoint 2).*

Two different methods to transmit a power setpoint via CANopen are detailed below.

These are "Transmitting a power setpoint via RPDO" and "Transmitting a power setpoint via default SDO communication channel". The advantages and the disadvantages of these two methods are as follows.

RPDO	Default SDO communication channel
Classical communication for CANopen devices	Configuration process
One message	Two messages
No validation of the received answer	Validation answer, if message has been received by the unit
Only working in operational mode	May take longer in case of communication with two messages

Table 82: Comparison

#### 6.5.1.5.1 RPDO

##### Configure CAN interface 1

CANopen Master (parameter 8993 ↪ p. 353) must be enabled, if there is no PLC taking over the master function.

1. ➤ Either on the front panel or using ToolKit navigate to menu "Configure CAN interface ➔ Configure CAN interface 1".
2. ➤ Configure the parameter listed below.

ID	Parameter	Value	Comment
8993	CANopen Master	On	CANopen Master is enabled.



## Configure RPDO

1. ➤ Either on the front panel or using ToolKit navigate to menu "Configure CAN interface 1 ➔ Receive PDO 1".
2. ➤ Configure the parameters listed below.

ID	Parameter	Value	Comment
9300	COB-ID	00000321 (hex)	COB-ID set to 00000321.
9910	Number of Mapped Objects	1	One mapped object is configured
9911	1. Mapped Object	00507	The 1st mapped object is set to control parameter 507.



*Setting the COB-ID to 321 (hex) is exemplary; usually, the PDOs are in the range of 181 (hex) to 57F (hex).*

With this setting, the Receive PDO is set to the address, for which the device is listening on the bus. The number of mapped objects is 1 since 1 mapped object is used. The request on the bus is sent with the control parameter 507 of the device as mapped object 1.



*Refer to [Chapter 9.2.4 "Additional Data Identifier"](#) on page 663 for a list of additional parameter groups.*

## CANopen message

The following table shows exemplary send data for the device on the CANopen bus in line 1.

A power setpoint of 1000.0 kW is transmitted:

- 10000 (dec) = 2710 (hex) → 10 27 according to the CANopen protocol

ID (hex)	Description	Data (hex)
321	Remote P setpoint	10 27 00 00

### 6.5.1.5.2 Default SDO Communication Channel

Another possibility for transmitting a power setpoint is to send the value via default SDO communication channel. The device listens to the CAN ID 600 (hex) + Node-ID internally to perform the desired control, the reply is on CAN ID 580 (hex) + Node-ID.

The following example shows the send format on CANopen with Node-ID 1.

The value is sent on the bus via the control parameter 507 of the device.

The hexadecimal value 2000 is calculated internally:

- 507 (dec) -- 1FB (hex)
- 1FB (hex) + 2000 (hex) = 21FB (hex)



*Please note that high and low bytes are exchanged in the sent value.*

ID (hex)	Description	Data (hex)
601	Remote P setpoint	23 FB 21 01 10 27 00 00

The data (hex) shows the state of parameter 507 to achieve the required control.



The table above shows exemplary send data for the device on the CANopen bus in line 2.

### 6.5.1.6 Transmitting Multiple Setpoints

A single RPDO can transmit multiple objects. The receive PDO can be used for four objects with 16 bits (2 bytes).

If larger objects - for example 32 bits (4 bytes), like for voltage and power setpoints - are used, the maximum number of objects is reduced.

## Configure RPDO

1.  Either on the front panel or using ToolKit navigate to menu “Configure CAN interface 1 → Receive PDO 1”.
2.  Configure the parameters listed below.

ID	Parameter	Value	Comment
9300	COB-ID	00000321 (hex)	COB-ID set to 00000321.
9910	Number of Mapped Objects	3	Three mapped objects are configured
9911	1. Mapped Object	00509	The 1st mapped object is set to control parameter 509.
9912	2. Mapped Object	00507	The 2nd mapped object is set to control parameter 507.
9913	3. Mapped Object	00508	The 3rd mapped object is set to control parameter 508.



*Setting the COB-ID to 321 (hex) is exemplary; usually, the PDOs are in the range of 181 (hex) to 57F (hex).*

With this setting, the Receive PDO is set to the address, for which the device is listening on the bus. The number of mapped objects is 1 since 1 mapped object is used. The request on the bus is sent with the control parameters 509, 507, and 508 of the device as mapped object 1.



*Refer to  Chapter 9.2.4 “Additional Data Identifier” on page 663 for a list of additional parameter groups.*

## CANopen message

The following table shows exemplary send data for the device on the CANopen bus in line 1. The following setpoints are transmitted:

- Frequency 50.6 Hz (5060 (dec) = 13C4 (hex) → C4 13 according to the CANopen protocol)
- Power 1000 kW (10000 (dec) = 2710 (hex) → 10 27 according to the CANopen protocol)
- Power factor 0.9 lagging (900 (dec) = 0384 (hex) → 84 03 according to the CANopen protocol)

ID (hex)	Description	Data (hex)
321	Remote F P PF setpoint	C4 13 10 27 00 00 84 03

### 6.5.1.7 Remotely Changing The Setpoint

It is possible to remotely change a setpoint value via the CANopen protocol using the parameter 504. In order to use the Logics-Manager command variables for example to enable the second set, different bits of parameter 504 must be enabled:

- 04.37 Remote voltage setpoint 2 - bit 4 - 10 00 (hex) must be sent to parameter 504
- 04.38 Remote frequency setpoint 2 - bit 5 - 20 00 (hex) must be sent to parameter 504
- 04.39 Remote Power Factor setpoint 2 - bit 6 - 30 00 (hex) must be sent to parameter 504
- 04.40 Remote power setpoint 2 - bit 7 - 80 00 (hex) must be sent to parameter 504



*For remotely changing the control setpoints, it is necessary to use the interface setpoints instead of the internal setpoints as data source in the respective controller.*

*For example, use data source "05.03 Interface freq.setp." in parameter 5518 ↗ p. 305 (Freq. setpoint 1 source) to transmit a frequency setpoint via interface.*

Two different methods for changing a setpoint via CANopen are detailed below.

These are "Changing a setpoint via RPDO" and "Changing a setpoint via default SDO communication channel". The advantages and the disadvantages of these two methods are as follows.

RPDO	Default SDO communication channel
Classical communication for CANopen devices	Configuration process
One message	Two messages
No validation of the received answer	Validation answer, if message has been received by the unit
Only working in operational mode	May take longer in case of communication with two messages

Table 83: Comparison

### 6.5.1.7.1 RPDO

#### Configure CAN interface 1

CANopen Master (parameter 8993 ↗ p. 353) must be enabled, if there is no PLC taking over the master function.

1. ➤ Either on the front panel or using ToolKit navigate to menu "Configure CAN interface ➔ Configure CAN interface 1".
2. ➤ Configure the parameter listed below.

ID	Parameter	Value	Comment
8993	CANopen Master	On	CANopen Master is enabled.

## Configure RPDO

1. ➤ Either on the front panel or using ToolKit navigate to menu "Configure CAN interface 1 ➔ Receive PDO 1".
2. ➤ Configure the parameters listed below.

ID	Parameter	Value	Comment
9300	COB-ID	00000321 (hex)	COB-ID set to 00000321.
9910	Number of Mapped Objects	1	One mapped object is configured
9911	1. Mapped Object	00504	The 1st mapped object is set to control parameter 504.



*Setting the COB-ID to 321 (hex) is exemplary; usually, the PDOs are in the range of 181 (hex) to 57F (hex).*

With this setting, the Receive PDO is set to the address, for which the device is listening on the bus. The number of mapped objects is 1 since 1 mapped object is used. The request on the bus is sent with the control parameter 504 of the device as mapped object 1.

## CANopen message

The following table shows exemplary send data for the device on the CANopen bus. The respective bits are enabled by sending the data of the respective lines.

ID (hex)	Description	Data (hex)
321	Remote P setpoint 2	80 00
321	Remote PF setpoint 2	40 00
321	Remote F setpoint 2	20 00
321	Remote V setpoint 2	10 00

### 6.5.1.7.2 Default SDO Communication Channel

Another possibility for changing a setpoint is to enable the bit via default SDO communication channel. The device listens to the CAN ID 600 (hex) + Node-ID internally to perform the desired control, the reply is on CAN ID 580 (hex) + Node-ID.

The following example shows the send format on CANopen with Node-ID 1.

The value is sent on the bus via the control parameter ID 504 of the device.

The hexadecimal value 2000 is calculated internally:

- 504 (dec) -- 1F8 (hex)
- 1F8 (hex) + 2000 (hex) = 21F8 (hex)



*Please note that high and low bytes are exchanged in the sent value.*

The data (hex) shows the state of parameter 504 to achieve the required control.

The following table shows exemplary send data for the device on the CANopen bus.

Identifier	Description	Data
601	Remote P setpoint 2	2B F8 21 01 80 00
601	Remote PF setpoint 2	2B F8 21 01 40 00
601	Remote F setpoint 2	2B F8 21 01 20 00
601	Remote V setpoint 2	2B F8 21 01 10 00

### 6.5.1.8 Transmitting A Remote Control Bit

It is possible to transmit a remote control bit via the CANopen protocol. Such a remote control bit can be sent by a PLC to remotely control the easYgen if this remote control bit is used as a command variable in a LogicsManager function.

## Configure RPDO

1. ➤ Either on the front panel or using ToolKit navigate to menu "Configure CAN interface 1 ➔ Receive PDO 1".
2. ➤ Configure the parameters listed below.

ID	Parameter	Value	Comment
9300	COB-ID	00000334 (hex)	COB-ID set to 00000334.
9910	Number of Mapped Objects	1	One mapped object is configured
9911	1. Mapped Object	00505	The 1st mapped object is set to control parameter 505.



*Setting the COB-ID to 334 (hex) is exemplary; usually, the PDOs are in the range of 181 (hex) to 57F (hex).*

With this setting, the Receive PDO is set to the address, for which the device is listening on the bus. The number of mapped objects is 1 since 1 mapped object is used. The request on the bus is sent with the control parameter 505 of the device as mapped object 1.



*Refer to [Chapter 9.2.4 "Additional Data Identifier"](#) on page 663 for a list of additional parameter groups.*

## CANopen message

The following table shows exemplary send data for the device on the CANopen bus.

Remote control bit 1 is set:

- 1 (dec) = 0001 (hex) → 01 00 according to the CANopen protocol

ID (hex)	Description	Data (hex)
334	Remote Control Bit 1 (PDO)	01 00

### 6.5.1.8.1 Default SDO Communication Channel

Another possibility for transmitting a power setpoint is to send the value via default SDO communication channel. The device listens to the CAN ID 600 (hex) + Node-ID internally to perform the desired control, the reply is on CAN ID 580 (hex) + Node-ID.

The following example shows the send format on CANopen with Node-ID 1.

The value is sent on the bus via the control parameter 249 of the device.

The hexadecimal value 2000 is calculated internally:

- 249 (dec) -- 1F9 (hex)
- 1FB (hex) + 2000 (hex) = 21F9 (hex)



Please note that high and low bytes are exchanged in the sent value.

ID (hex)	Description	Data (hex)
601	Remote Control Bit 1 (SDO)	2B F9 21 01 01 00 00 00

The data (hex) shows the state of parameter 249 to achieve the required control.

The table above shows exemplary sends data for the device on the CANopen bus in line 2.

### 6.5.2 Sending A Data Protocol via TPDO

This is a configuration example for sending an object (data protocol 5003) on CAN ID 2AE (hex) every 20 ms on TPDO1. For this, TPDO1 must be configured as follows:

1. ➤ Either on the front panel or using ToolKit navigate to menu "Configure CAN interface 1 ➔ Transmit PDO 1".
2. ➤ Configure the parameters listed below.

ID	Parameter	Value	Comment
9600	COB-ID	000002AE (hex)	COB-ID set to 000002AE.
9602	Transmission type	255	The number of required sync messages is set to 255.
9604	Event timer	20 ms	Object is sent every 20 ms.
8962	Selected data protocol	5003	Data protocol 5003 is used.
9609	Number of Mapped Objects	0	No mapped object is configured

The data to be sent (Mapped Objects) may be provided on request by configuring the Sync Message (parameter 9100 ↪ p. 354) and the Transmission Type (parameter 9602 ↪ p. 360, 9612 ↪ p. 360, 9622 ↪ p. 360, 9632 ↪ p. 360, or 33642 ↪ p. 360) of a TPDO. The unit is requested to send its data by sending a Sync Message.

The number of required Sync Messages is determined by the setting of the Transmission Type.

If the data is to be sent on request, Bit 30 of the Sync Message (parameter 9100 ↪ p. 354) must be configured to "0" and the CAN-open Master (parameter 8993 ↪ p. 353) function must be configured to "Off".

#### Additional example

The Transmission Type of TPDO 1 (parameter 9602 ↪ p. 360) is configured to "2" in the following example. This means that a message of the configured TPDO is sent by the unit after two Sync Messages have been sent to the unit.



1. ▶ Either on the front panel or using ToolKit navigate to menu "Configure CAN interface 1 → Transmit PDO 1".
2. ▶ Configure the parameters listed below.

ID	Parameter	Value	Comment
9600	COB-ID	000002AE (hex)	COB-ID set to 000002AE.
9602	Transmission type	2	The number of required sync messages is set to 2.
9604	Event timer	20 ms	Object is sent every 20 ms.
8962	Selected data protocol	5003	Data protocol 5003 is used.
9609	Number of Mapped Objects	0	No mapped object is configured

The recorded data shows that the data of the Mapped Object (in this example Mux 5) is sent ( ↺ "Cyclical sending of data - sync message request" on page 497) after sending the Sync Message twice ( ↺ "Cyclical sending of data - reply" on page 497).

ID (hex)	Description	Data (hex)
80	-	-

Table 84: Cyclical sending of data - sync message request

No.	Count	ID (hex)	Data (hex)
1	2	80	-
2	1	2AE	8B 13

Table 85: Cyclical sending of data - reply

## 6.5.3 Troubleshooting

### General diagnosis

Error	Possible diagnosis
Connected device (Phoenix I/O board) cannot be configured	Are all LEDs at the expansion modules illuminated green (i.e. correctly connected)?
	Are all modules detected (i.e. no blinking expansion module)?

### CAN interface 1 (guidance level) diagnosis

Error	Possible diagnosis
No data is sent by the Woodward controller	Is the unit in operational mode (heartbeat - CAN ID 700 (hex) + Node-ID has the content 5 (hex)?
	Are the TPDOs correctly configured (CAN ID, mapping, parameter)?

Error	Possible diagnosis
No data is received by the Woodward controller	Is the unit in operational mode (heartbeat - CAN ID 700 (hex) + Node-ID has the content 5 (hex))?
	Are the RPDOs correctly configured (CAN ID, mapping, parameter)?
No monitoring bit data is received on the RPDO	Is the CAN bus connected correctly?
	Is the baud rate configured correctly?
	Is the CAN ID assigned more than once?
	Is the unit in operational mode? If not, start it via another device or put in NMT Master (parameter 8993 ↗ p. 353).
	No SDOs (configuration messages) are received by the unit
No SDOs (configuration messages) are received by the unit	Is the CAN ID assigned more than once?
	Is the CAN ID 600 (hex) + Node-ID of the easYgen already used in a PDO (COB-ID)?
	Are RPDOs or TPDOs higher than 580 (hex) or lower than 180 (hex) used?

## 6.6 Modbus Applications

### 6.6.1 Remote Control

#### 6.6.1.1 Remote Start/Stop, Shutdown, And Acknowledgement

The Woodward controller may be configured to perform start/stop/acknowledgement functions remotely through the Modbus protocol. The required procedure is detailed in the following steps.



*The following descriptions refer to the remote control parameter 503 as described in ↗ Chapter 9.2.4 "Additional Data Identifier" on page 663.*

*It may be necessary to shift the address by 1 depending on the used PC software. In this case, the address would be 504 for example.*

*Be sure to check both possibilities in case of remote control problems.*

ID	Parameter	Setting range	Data type
503	Remote control word 1	0 to 65535	UNSIGNED 16

- Modbus address = 40000 + (Par. ID +1) = 40504
- Modbus length = 1 (UNSIGNED 16)

In order to issue a command, the respective bit of object 21F7 (hex), i.e. parameter 503, must be enabled. The following bits are used for this:

- Bit 0 Start bit:  
This bit activates the LogicsManager command variable 04.13 "Remote request" and enables a remote start.
- Bit 1 Stop bit:  
This bit deactivates the LogicsManager command variable 04.13 "Remote request" and disables a remote start.

- Bit 4 Acknowledgement bit:  
This bit activates the LogicsManager command variable 04.14 "Remote acknowledge". This bit must be set and reset twice to acknowledge an alarm completely. The first rising edge disables the horn and the second rising edge resets the alarm.
- Bit 9 Shutdown Command bit:  
This bit activates the LogicsManager command variable 03.40 "Remote Shutdown-Status". With this function the engine is immediately shut down without auxiliary service and cool down. This works independent from breacker conditions.

The following Modscan32 screenshot ( Fig. 234) shows the configurations made to remote control parameter 503. It is possible to set the format to binary to view single bits using the "display options".

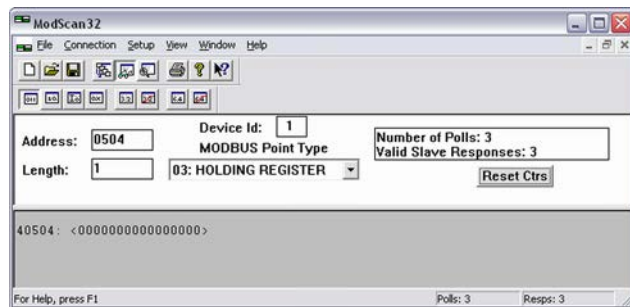

Fig. 234: Modbus - remote control parameter 503

### Example 1: Start Request



Fig. 235: Modbus - write register - start request

By double-clicking the address, a Write Register command may be issued.

Fig. 235 shows how bit 0 is set using the ModScan32 Software.

### Example 2: Stop Request



Fig. 236: Modbus - write register - stop request

By double-clicking the address, a Write Register command may be issued.

Fig. 236 shows how bit 1 is set using the ModScan32 Software.

### Example 3: External Acknowledge



Fig. 237: Modbus - write register - external acknowledge

By double-clicking the address, a Write Register command may be issued.

Fig. 237 shows how bit 4 is set using the ModScan32 Software.

**Example 4: Shutdown Command**



Fig. 238: Modbus - write register - shutdown command

By double-clicking the address, a Write Register command may be issued.

Fig. 237 shows how bit 9 is set using the ModScan32 Software.

**Sample for Free alarm 1**

This (remote) shutdown request can be taken by LogicsManager equation 12230 to set Flag 1 (see Fig. 239). To perform an immediately shutdown, the free alarm has to be configured as alarm class F. Free alarm 1 configuration Fig. 240 shows how the Monitoring source 6684 is set to Flag 1 and the Alarm class 5161 is set to Class F.

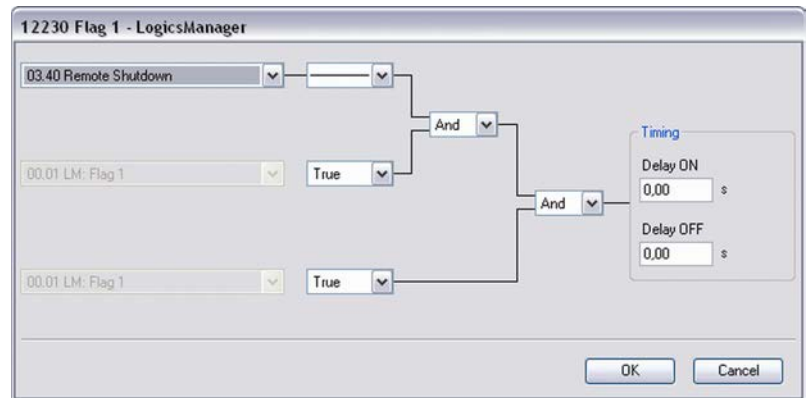

Fig. 239: LM-12230-Flag1\_EN

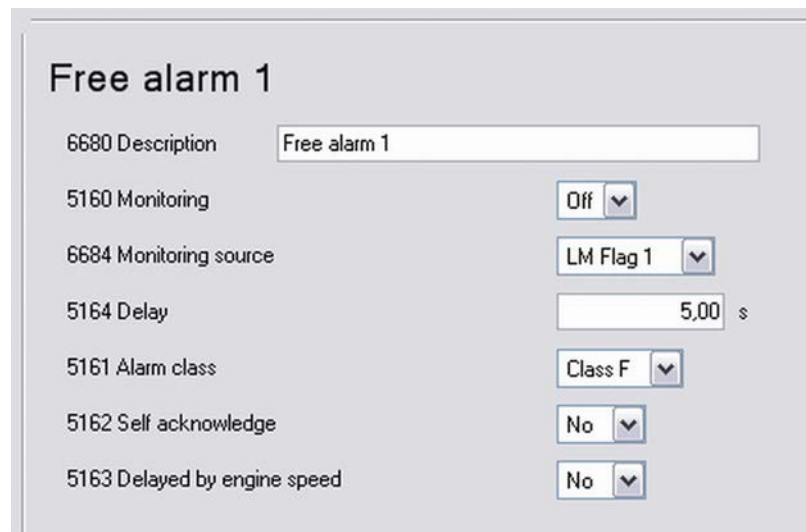

Fig. 240: LM\_Free-Alarms\_EN

### 6.6.1.2 Setpoint Setting

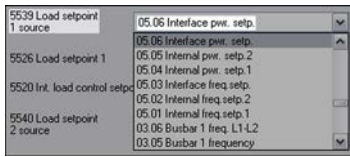

Fig. 241: Setpoint source configuration

For a remote setting of the control setpoints, it is necessary to use the interface setpoints instead of the internal setpoints.

For example, use data source "05.06 Interface pwr. setp." in parameter 5539 (Load setpoint 1 source) to transmit a load setpoint via interface.

No password is required to write this value. shows an exemplary configuration of the load setpoint 1 source. All other setpoint sources are configured accordingly.

The interface setpoints may be set using the objects for active power, power factor, frequency, and voltage (refer to Chapter 9.2.4 "Additional Data Identifier" on page 663 for detailed information).

ID	Parameter	Setting range	Unit	Data type	Data source
507	Active Power Setpoint	0 to 999999	1/10 kW	INTEGER 32	05.06
508	Power Factor Setpoint	-710 to 1000 to 710	-	INTEGER 16	05.12
509	Frequency Setpoint	0 to 7000	1/100 Hz	UNSIGNED 16	05.03
510	Voltage Setpoint	50 to 650000	V	UNSIGNED 32	05.09

#### Example 1: Active power interface setpoint

The active power setpoint value must be written to object 21FB (hex), i.e. parameter 507.

##### Example

A power value of 50 kw = 500 (dec) = 01F4 (hex) is to be transmitted.

- Modbus address = 40000 + (Par. ID + 1) = 40508
- Modbus length = 2 (INTEGER 32)

The high word must be written to the lower address and the low word must be written to the higher address.

To set the parameter address in ModScan32:

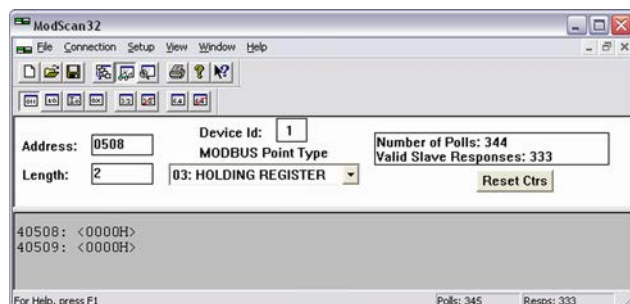

Fig. 242: Modscan32 at address 40508

1. Open the "Preset Multiple Registers" dialog by selecting "Setup → Extended → Preset Regs" from the menu.



Fig. 243: "Preset Multiple Registers" dialog 1

2. Select "OK" and enter the desired values.



Fig. 244: "Preset Multiple Registers" dialog 2

3. Select "Update" to confirm the entered values.  
 ⇒ The dialog closes and the values are changed.

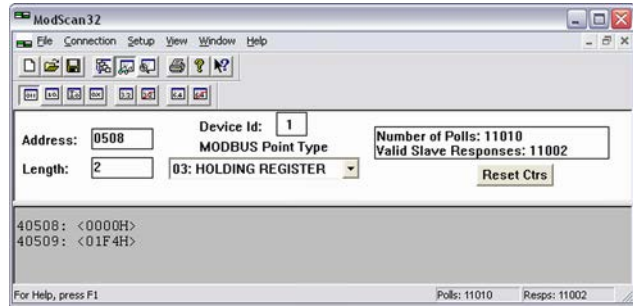

Fig. 245: Modscan32 at address 40508

**Example 2: Power factor interface setpoint**

The power factor setpoint value must be written to object 21FC (hex), i.e. parameter 508.

**Example**

A power factor of 1 = 1000 (dec) = 03E8 (hex) is to be transmitted.

- Modbus address = 40000 + (Par. ID + 1) = 40509
- Modbus length = 1 (UNSIGNED 16)

To set the parameter address in ModScan32:

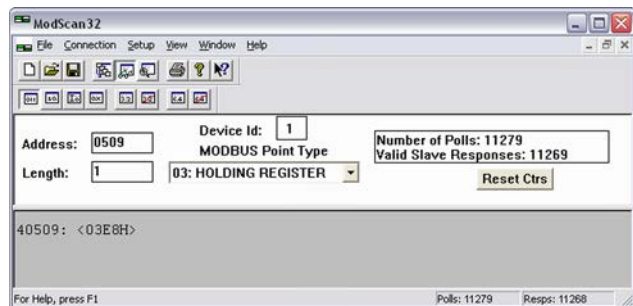

Fig. 246: Modscan32 at address 40509

➔ Analogous to "Example 1: Active power interface setpoint" on page 501 set the parameter address as shown in (Fig. 246).

**Example 3: Frequency interface setpoint**

The frequency setpoint value must be written to object 21FD (hex), i.e. parameter 509.

**Example**

A frequency value of 50.00 Hz = 5000 (dec) = 1388 (hex) is to be transmitted.

- Modbus address = 40000 + (Par. ID + 1) = 40510
- Modbus length = 1 (UNSIGNED 16)

To set the parameter address in ModScan32:

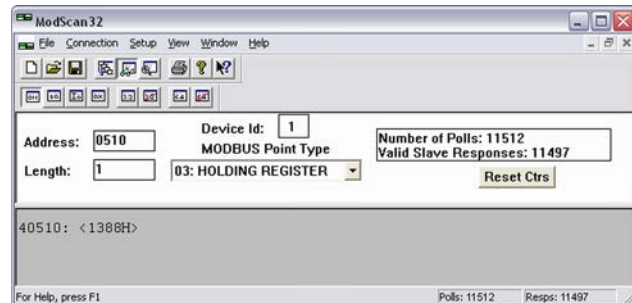

Fig. 247: Modscan32 at address 40510

➔ Analogous to [“Example 1: Active power interface setpoint” on page 501](#) set the parameter address as shown in (Fig. 247).

**Example 4: Voltage interface set-point**

The voltage setpoint value must be written to object 21FE (hex), i.e. parameter 510.

**Example**

A voltage value of 400 V = 400 (dec) = 0190 (hex) is to be transmitted.

- Modbus address = 40000 + (Par. ID + 1) = 40511
- Modbus length = 2 (UNSIGNED 32)

The high word must be written to the lower address and the low word must be written to the higher address.

To set the parameter address in ModScan32:

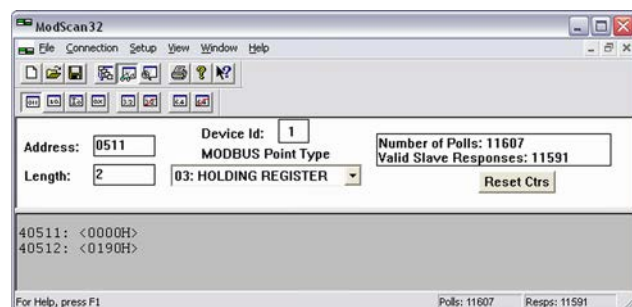

Fig. 248: Modscan32 at address 40511

➔ Analogous to [“Example 1: Active power interface setpoint” on page 501](#) set the parameter address as shown in (Fig. 248).

**6.6.1.3 Remotely Changing The Setpoint**

It is possible to remotely change the (active power/power factor/frequency/voltage) setpoints through the Modbus using the parameter 504 ([Chapter 9.2.4 “Additional Data Identifier” on page 663](#)). The required procedure is detailed in the following steps.

ID	Parameter	Setting range	Data type
504	Remote control word 2	Yes / No	UNSIGNED 16

In order to enable a setpoint, the respective bit of object 21F8 (hex), i.e. parameter 504, must be enabled. The following bits are used for this:

- Bit 4 Request voltage setpoint 2:  
This bit activates the LogicsManager command variable 04.37 "Remote voltage setpoint 2" and is dedicated for switching from voltage setpoint 1 to voltage setpoint 2.
- Bit 5 Request frequency setpoint 2:  
This bit activates the LogicsManager command variable 04.38 "Remote frequency setpoint 2" and is dedicated for switching from frequency setpoint 1 to frequency setpoint 2.
- Bit 6: Request power factor setpoint 2:  
This bit activates the LogicsManager command variable 04.39 "Remote PF setpoint 2" and is dedicated for switching from power factor setpoint 1 to power factor setpoint 2.
- Bit 7: Request active power setpoint 2:  
This bit activates the LogicsManager command variable 04.40 "Remote power setpoint 2" and is dedicated for switching from active power setpoint 1 to active power setpoint 2.

**Example**

The active power setpoint 2 is to be enabled.

- Modbus address = 40000 + (Par. ID + 1) = 40505
- Modbus length = 1 (UNSIGNED 16)

To set the bits in ModScan32:

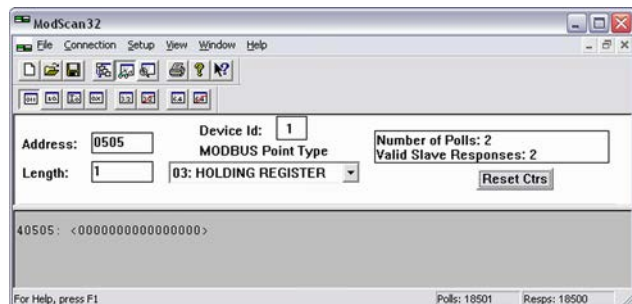

Fig. 249: ModScan32 single bit view

1. Using the "display options" set the format to binary to view single bits ( Fig. 249).



2. Double-click the address to issue a Write Register command.

⇒ Fig. 250 shows how bit 7 is set to enable the active power setpoint 2.



Fig. 250: Active power setpoint



Fig. 251: Power factor setpoint

Fig. 251 shows how bit 6 would be set to enable the power factor setpoint 2.



Fig. 252: Frequency setpoint

Fig. 252 shows how bit 5 would be set to enable the frequency setpoint 2.



Fig. 253: Voltage setpoint

Fig. 253 shows how bit 4 would be set to enable the voltage setpoint 2.

## 6.6.2 Changing Parameter Settings

### 6.6.2.1 Parameter Setting



The example tables below are excerpts. Refer to the following chapters for the complete parameter lists:

- Chapter 4.1.4 “Enter Password” on page 89
- Chapter 4.2 “Configure Measurement” on page 94



Be sure to enter the password for code level 2 or higher for the corresponding interface to get access for changing parameter settings.



The new entered value must comply with the parameter setting range when changing the parameter setting.

**Example 1: Addressing the password for serial interface 1**

ID	Parameter	Setting range	Data type
10401	Password for serial interface1	0000 to 9999	UNSIGNED 16

**Example**

- Modbus address = 400000 + (Par. ID + 1) = 410402
- Modbus length = 1 (UNSIGNED 16)

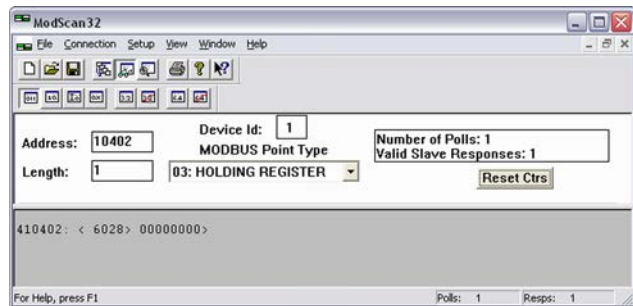

Fig. 254: Modscan32 at address 410402

➔ Set the configuration to address parameter 10401 as shown in ( Fig. 254).

**Example 2: Addressing the generator rated voltage**

ID	Parameter	Setting range	Data type
1766	Generator rated voltage	50 to 650000 V	UNSIGNED 32

**Example**

- Modbus address = 400000 + (Par. ID + 1) = 41767
- Modbus length = 2 (UNSIGNED 32)

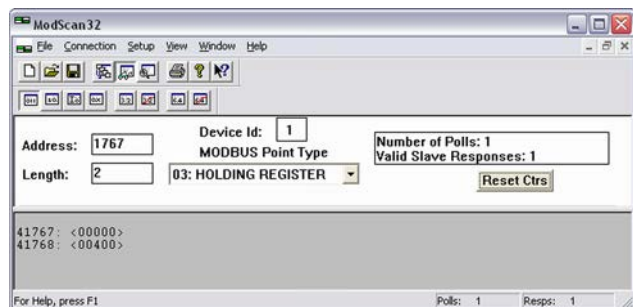

Fig. 255: Modscan32 at address 41767

➔ Set the configuration to address parameter 1766 as shown in ( Fig. 255).

**Example 3: Addressing the generator voltage measuring**

ID	Parameter	Setting range	Data type
1851	Generator voltage measuring	3Ph 4W 3Ph 3W 1Ph 2W 1Ph 3W	UNSIGNED 16

**Example**

- Modbus address = 40000 + (Par. ID + 1) = 41852
- Modbus length = 1 (UNSIGNED 16)



*If the setting range contains a list of parameter settings like in this example, the parameter settings are numbered and start with 0 for the first parameter setting. The number corresponding with the respective parameter setting must be configured.*

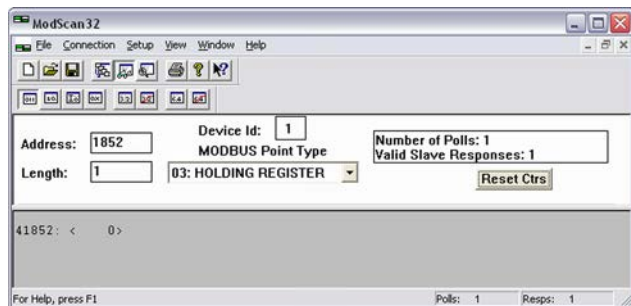

Fig. 256: Modscan32 at address 41852

- ➔ Set the configuration to address parameter 1851 as shown in ( Fig. 256).
- ⇒ The parameter is configured to "3Ph 4W".

**6.6.2.2 Configuration Of LogicsManager Functions**

Next to HMI and ToolKit, LogicsManager can also be configured via Modbus.

- The complete LogicsManager instruction set is available for Modbus control.
- Hex code equivalents are defined for all LogicsManager settings.
- The Modbus definition for a LogicsManager equation consists of 7 data words following a well defined sequence.

Word 0	Word 1	Word 2	Word 3	Word 4	Word 5	Word 6
Delay ON	Delay OFF	Logic equation 1	Logic equation 2	Command 1	Command 2	Command 3

Table 86: 7 words Modbus message

To send a LogicsManager function via Modbus follow these steps:

1. Define your LogicsManager equation
2. Describe the LogicsManager equation as "command chain" in hex code
3. Send the message via Modbus

**Describe the LogicsManager equation as "command chain" in hex code (step 2)**

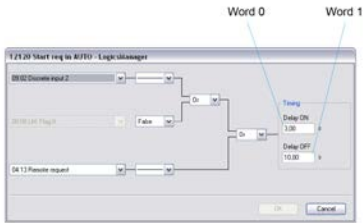

Fig. 257: LogicsManager command chain words 0 and 1

The LogicsManager screens below show parts of the command chain. How to generate hex code words is described for each part of the Modbus message.

Word 0 and word 1 contain the the hex code of the Delay times but in the reverse order of double-byte words, i.e. low byte before high byte.

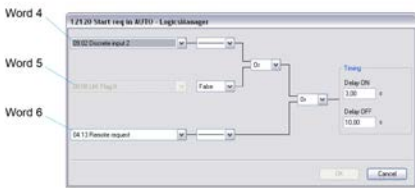

Fig. 258: LogicsManager command chain words 4, 5, and 6

Words 4, 5, and 6 contain the hex codes of the respective command variable ID's decimal value but in the reverse order of double-byte words, i.e. low byte before high byte.

**i** The command variable prefix e.g., "04.13" is the number of the command variable not it's ID.  
 Refer to Chapter 9.4.4 "Logical Command Variables" on page 697 for the command variable IDs.

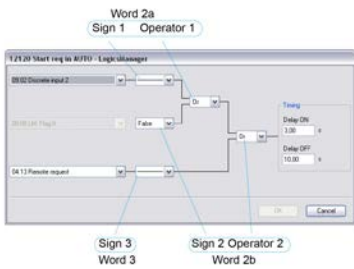

Fig. 259: LogicsManager command chain words 2 and 3

Words 2 and 3 contain a sequence of nibbles each representing a sign or operator of the equation.

The Data words table below shows the sequence how to arrange the LogicsManager setting that build the command chain.

Word 2				Word 3			
Sign 1	Operator 1	Sign 2	Operator 2	Sign 3	not used	not used	not used

Table 87: Data words 2 and 3 - details of the logic equations

Please find the hex code equivalents on the table below:

Signs		Operators	
"NOT"	0	"AND"	0
"_"	1	"NAND"	1
"TRUE"	2	"OR"	2
"FALSE"	3	"NOR"	3

Signs		Operators	
		"XOR"	4
		"NOT-XOR"	5

Table 88: Hex code equivalents of the logic equations' nibbles



The hex code of words 2 and 3 is taken "as is" — don't swap high byte and low byte.

**Write the Modbus message (step 3)**



It may be necessary to shift the address by 1 depending on the software you use for Modbus communication.

➔ Copy the complete message of 7 words to the address [parameter number +1] in one step.

Word 0		Word 1		Word 2				Word 3			Word 4		Word 5		Word 6		
Delay ON		Delay OFF		Logic equation 1				Logic equation 2			Command 1		Command 2		Command 3		
low byte	high byte	low byte	high byte	Sign 1	Operator 1	Sign 2	Operator 2	Sign 3	0x00	0x00	0x00	low byte	high byte	low byte	high byte	low byte	high byte

Table 89: 7 words Modbus message in detail

Example

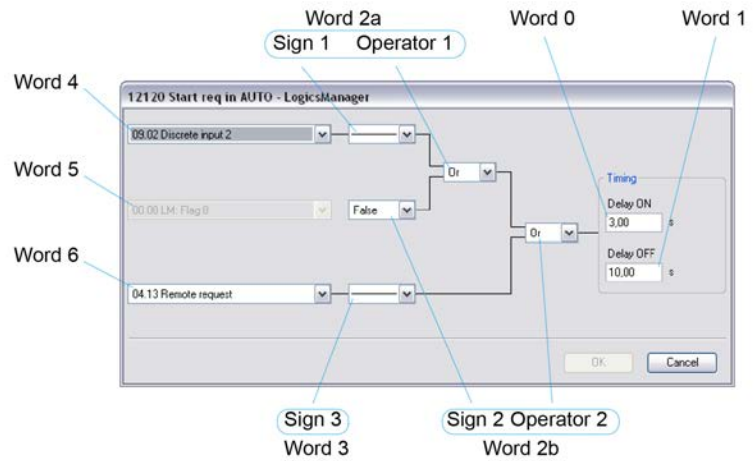

Fig. 260: LogicsManager command chain sample 12120

Word 0		Word 1		Word 2				Word 3				Word 4		Word 5		Word 6	
Delay ON		Delay OFF		Logic equation 1				Logic equation 2				Command 1		Command 2		Command 3	
3.00 sec		10.00 sec		—	Or	False	Or	—	-/-	-/-	-/-	No. 09.02 ID = 520 dec, 0208 hex		No. 00.08 ID = 7 dec, 0007 hex		No. 04.13 ID = 251 dec, 00FB hex	
low byte	high byte	low byte	high byte	Sign 1	Oper- ator 1	Sign 2	Oper- ator 2	Sign 3	0x00	0x00	0x00	low byte	high byte	low byte	high byte	low byte	high byte
2C	01	E8	03	1	2	3	2	1	0	0	0	08	02	07	00	FB	00

Table 90: 7 words Modbus message sample 12120 in detail

The Modbus message for the LogicsManager equation used for description above is 2C01 / E803 / 1232 / 1000 / 0802 / 0700 / FB00 (hex).

6.6.2.3 Configuration Of LogicsManager Functions For Remote Access

6.6.2.3.1 Basic remote control functions

The following chapters describe how to parametrize the Logics-Manager via Modbus for the following basic remote control functions:

- Change to AUTOMATIC mode: 12510 Operat. mode AUTO
- Remote request start/stop: 12120 Start req. in AUTO
- Remote acknowledge: 12490 Ext. acknowledge
- Remote shutdown: 11669 Remote Shutdown-status
- Start without load: 12540 Start w/o load

6.6.2.3.2 Configuration of the LogicsManager "Operation mode AUTO"



To fix the operating mode use the LogicsManager function 00.16 "Operat. mode AUTO" (parameter 12510 ↪ p. 280).

The operating mode AUTO LogicsManager function (parameter 12510 ↪ p. 280) can be configured in two different ways:

- 1. Automatic operating mode is always enabled
- 2. Automatic operating mode is enabled via discrete input



Refer to ↪ Chapter 6.4.5 "Performing Remote Start/ Stop And Acknowledgement" on page 436 for a detailed configuration of the LogicsManager via HMI or ToolKit.

Example

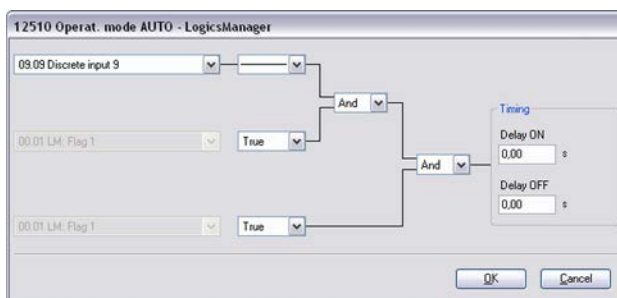

Fig. 261: LogicsManager function sample 12510

To configure the "Operat. mode AUTO" LogicsManager function (parameter 12510 ↪ p. 280) as indicated in (Fig. 261) the following Modbus message must be sent to the easYgen:

Word 0		Word 1		Word 2				Word 3			Word 4		Word 5		Word 6	
Delay ON		Delay OFF		Logic equation 1*				Logic equation 2*			Command 1		Command 2		Command 3	
		Sig n 1	Oper-ator 1	Sign 2	Oper-ator 2	Sig n 3	-/-	-/-	-/-							
0.00 sec	0.00 sec	—	And	True	And	True	00	00	00	No. 09.09 ID = 527 dec	No. 00.01 ID = 0 dec	No. 00.01 ID = 0 dec				
0000 (hex)	0000 (hex)	1	0	2	0	2	0	0	0	020F (hex)	0000 (hex)	0000 (hex)				
low byte	high byte	low byte	high byte	"as is"				"as is"			low byte	high byte	low byte	high byte	low byte	high byte
0000 (hex)	0000 (hex)	1020 (hex)				2000 (hex)			0F02 (hex)	0000 (hex)	0000 (hex)					



\* see ↗ “Hex code equivalents of the logic equations’ nibbles” on page 508 for reference

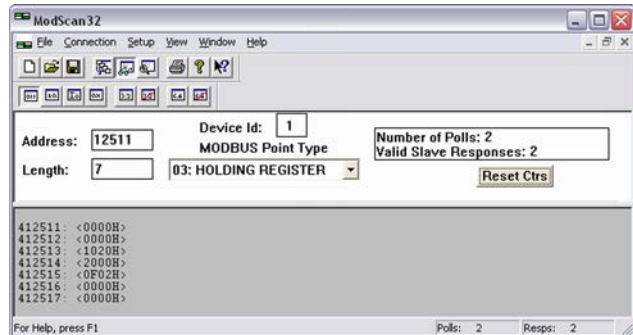

Fig. 262: Modscan32 at address 12511

➔ Copy the complete message of 7 words to address 12511 ff (12510+1) in one step.

This is shown in ( Fig. 262) using the ModScan32 software.



*If an shutdown alarm of alarm class C through F occurs in AUTOMATIC operating mode, the control does not return to STOP operating mode if the alarm is cleared after acknowledgement. This means that a restart is initiated.*

### 6.6.2.3.3 Configuration Of Remote Start/Stop, Shutdown, And Acknowledgement



*Refer to ↗ Chapter 6.4.5 “Performing Remote Start/ Stop And Acknowledgement” on page 436 for detailed information.*

The easYgen may start, stop, shut down, or acknowledge alarms with CAN/Modbus. Therefore, two logical command variables (04.13 and 04.14) have to be configured with the LogicsManager. 03.40 can handle Remote shutdown only.

- 04.13 Remote request
- 04.14 Remote acknowledge
- 04.30 Remote shutdown

### 6.6.2.3.4 Configuration Of LogicsManager Function "Start Request in AUTO"

The "Start req. in AUTO" LogicsManager function (parameter 12120 ↗ p. 279) can be configured in a way that a start request in AUTOMATIC operating mode is enabled as soon as a remote request is issued.

Refer to ↗ Chapter 6.4.5 “Performing Remote Start/Stop And Acknowledgement” on page 436 for information on configuration via HMI or ToolKit.



The remote request may be enabled by setting bit 0 (start) of the remote control word 503 to HIGH and may be disabled by setting bit 1 (stop) of the remote control word 503 to HIGH (refer to [Chapter 9.2.4 "Additional Data Identifier" on page 663](#)).

**Example**

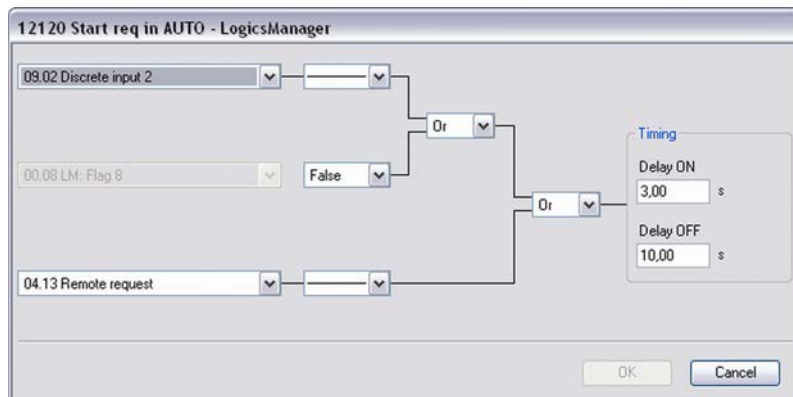

Fig. 263: LogicsManager function sample 12120

To configure the "Start req. in AUTO" LogicsManager function (parameter 12120 [p. 279](#)) as indicated in (Fig. 263) the following Modbus message must be sent to the easYgen:

Word 0	Word 1	Word 2				Word 3				Word 4	Word 5	Word 6
Delay ON	Delay OFF	Logic equation 1*				Logic equation 2*				Command 1	Command 2	Command 3
		Sig n 1	Oper-ator 1	Sign 2	Oper-ator 2	Sig n 3	-/-	-/-	-/-			
3.00 sec	10.00 sec	—	Or	False	Or	—	00	00	00	No. 09.02 ID = 520 dec	No. 00.08 ID = 7 dec	No. 04.13 ID = 251 dec
012c (hex)	03E8 (hex)	1	2	3	2	1	0	0	0	0208 (hex)	0007 (hex)	00FB (hex)

## Application

Word 0		Word 1		Word 2	Word 3	Word 4		Word 5		Word 6	
low byt e	high byte	low byt e	high byte	"as is"	"as is"	low byt e	high byte	low byt e	high byte	low byt e	high byte
2C01 (hex)		E803 (hex)		1232 (hex)	1000 (hex)	0802 (hex)		0700 (hex)		FB00 (hex)	



Fig. 264: Modscan32 at address 12121

➔ Copy the complete message of 7 words to address 12121 ff (12120+1) in one step.

This is shown in ( Fig. 264) using the ModScan32 software.

### 6.6.2.3.5 Configuration Of LogicsManager Function "External Acknowledge"

The "Ext. acknowledge" LogicsManager function (parameter 12490 ↪ p. 200) can be configured in a way that an external acknowledgement is performed as soon as the remote acknowledge signal is enabled.

Refer to the ↪ *Chapter 6.4.5 "Performing Remote Start/Stop And Acknowledgement" on page 436* for information on configuration via HMI or ToolKit.

External acknowledge may be enabled by setting bit 4 (external acknowledge) of the remote control word 503 to HIGH (refer to ↪ *Chapter 9.2.4 "Additional Data Identifier" on page 663*).

### Example

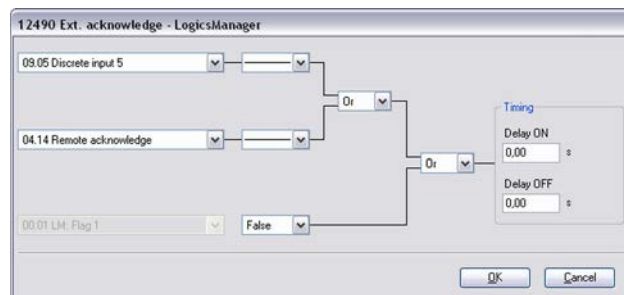

Fig. 265: LogicsManager function sample 12490

To configure the "External acknowledge" LogicsManager function (parameter 12490 ↪ p. 200) as indicated in (Fig. 265) the following Modbus message must be sent to the easYgen:

Word 0		Word 1		Word 2				Word 3				Word 4		Word 5		Word 6	
Delay ON		Delay OFF		Logic equation 1*				Logic equation 2*				Command 1		Command 2		Command 3	
		Sig n 1	Oper-ator 1	Sign 2	Oper-ator 2	Sig n 3	-/-	-/-	-/-								
0.00 sec		0.00 sec		—	Or	—	Or	Fal se	00	00	00	No. 09.05 ID = 523 dec		No. 04.14 ID = 252 dec		No. 00.01 ID = 0 dec	
0000 (hex)		0000 (hex)		1	2	1	2	3	0	0	0	020B (hex)		00FC (hex)		0000 (hex)	
low byte	high byte	low byte	high byte	"as is"				"as is"				low byte	high byte	low byte	high byte	low byte	high byte
0000 (hex)		0000 (hex)		1212 (hex)				3000 (hex)				0B02 (hex)		FC00 (hex)		0000 (hex)	

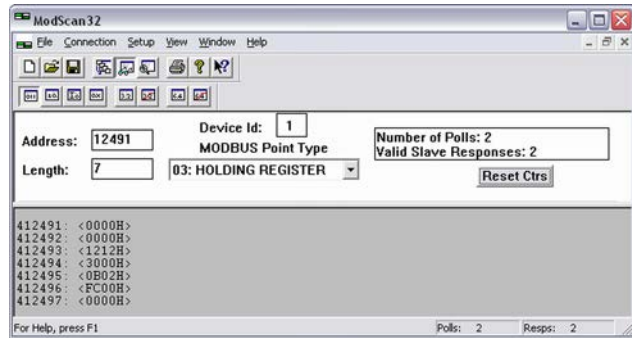

Fig. 266: Modscan32 at address 12491

➔ Copy the complete message of 7 words to address 12491 ff (12490+1) in one step.

This is shown in ( Fig. 266) using the ModScan32 software.

### 6.6.2.3.6 Configuration Of LogicsManager Function "Start w/o Load"

The Start w/o load LogicsManager function (parameter 12540 ↪ p. 279) can be configured in a way that it is always enabled.

Refer to ↪ Chapter 6.4.5 "Performing Remote Start/Stop And Acknowledgement" on page 436 for information on configuration via HMI or ToolKit.

Example

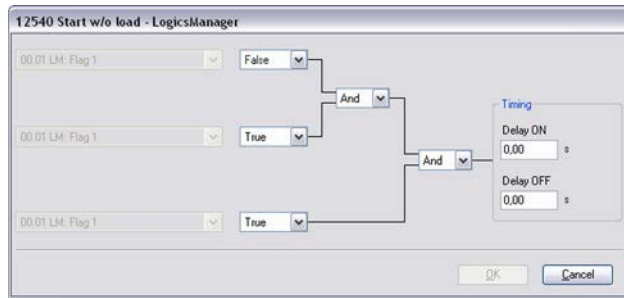

Fig. 267: LogicsManager function sample 12540

To configure the "Start w/o Load" LogicsManager function (parameter ID 12540 p. 279) as indicated in (Fig. 267) the following Modbus message must be sent to the easYgen:

Word 0		Word 1		Word 2				Word 3			Word 4		Word 5		Word 6	
Delay ON		Delay OFF		Logic equation 1*				Logic equation 2*			Command 1		Command 2		Command 3	
		Sig n 1	Oper- ator 1	Sign 2	Oper- ator 2	Sig n 3	-/-	-/-	-/-							
0.00 sec	0.00 sec	Fal se	And	True	And	Tru e	00	00	00	No. 00.01 ID = 0 dec	No. 00.01 ID = 0 dec	No. 00.01 ID = 0 dec				
0000 (hex)	0000 (hex)	3	0	2	0	2	0	0	0	0000 (hex)	0000 (hex)	0000 (hex)				
low byt e	high byte	"as is"				"as is"			low byt e	high byte	low byt e	high byte	low byt e	high byte		
0000 (hex)	0000 (hex)	3020 (hex)				2000 (hex)			0000 (hex)	0000 (hex)	0000 (hex)	0000 (hex)	0000 (hex)			

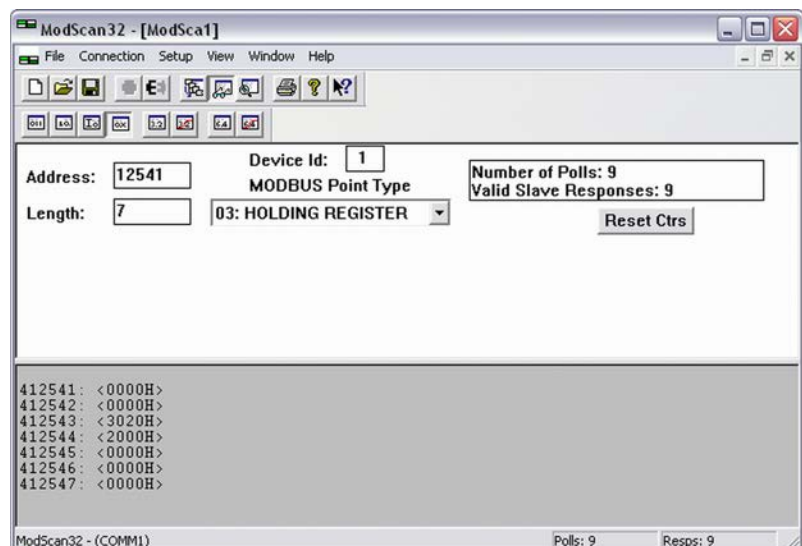

Fig. 268: Modscan32 at address 12541

➔ Copy the complete message of 7 words to address 12541 ff (12540+1) in one step.

This is shown in ( Fig. 268) using the ModScan32 software.

### 6.6.2.4 Remotely Acknowledge Single Alarm Messages

Single alarm messages can be acknowledged remotely through the Modbus by sending the respective parameter ID of the alarm to be acknowledged on parameter 522. The required procedure is detailed in the following steps.

ID	Parameter	Setting range	Data type
522	Reset alarm list	0 to 65535	UNSIGNED 16

The parameter ID of the alarm to be acknowledged must be written to object 220A (hex), i.e. parameter 522.

#### Example

A "Mains undervoltage 1" alarm (ID 3012) shall be acknowledged (refer to [Chapter 9.5.4.2 "Alarm Messages" on page 739](#)).

- Modbus address = 40000 + (Par. ID + 1) = 40523
- Modbus length = 1 (UNSIGNED 16)

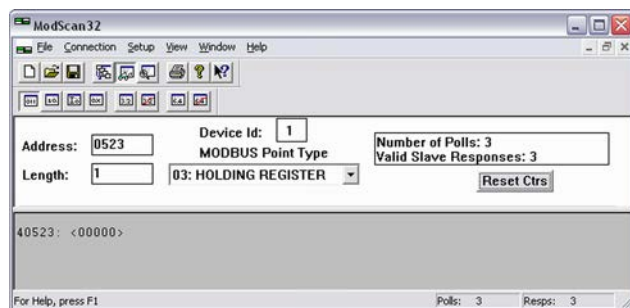

Fig. 269: ModScan32 at address 40523

1. Use the "display options" to set the format to decimal view.
2. Double-click the address to issue a Write Register command.

⇒ Fig. 270 shows how the parameter ID of the alarm to be acknowledged is written using the ModScan32 Software.



Fig. 270: Write register - acknowledge alarm message

### 6.6.2.5 Remotely Clearing The Event History

The event history can be cleared remotely through the Modbus. The required procedure is detailed in the following steps.

ID	Parameter	Setting range	Data type
1706	Clear eventlog	Yes / No	UNSIGNED 16

In order to clear the event history, bit 0 of object 26AA (hex), i.e. parameter 1706 [p. 93](#), must be enabled.

#### Example

The event history shall be cleared.

- Modbus address = 40000 + (Par. ID + 1) = 41707
- Modbus length = 1 (UNSIGNED 16)

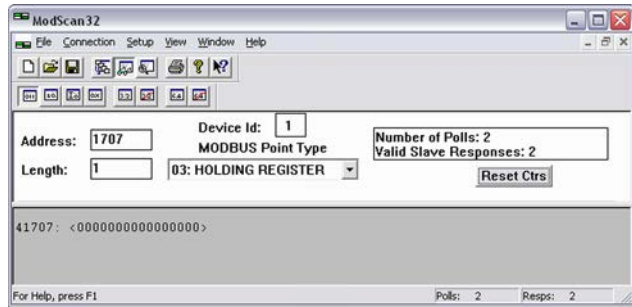

Fig. 271: Modscan32 at address 41707

1. Use the "display options" to set the value format to binary.
2. Double-click the address to issue a Write Register command.

⇒ Fig. 272 shows how bit 0 is enabled using the Mod-Scan32 Software.



Fig. 272: Write register - clear event history

### 6.6.2.6 Remotely Resetting The Default Values

#### 6.6.2.6.1 Modbus Via RS-232/RS-485

The unit can be reset to its default values through the Modbus (via RS-232 respectively RS-485 ) using the parameters 10417 ↪ p. 92/↪ p. 518 and 1701 ↪ p. 92. The required procedure is detailed in the following steps.

ID	Parameter	Setting range	Data type
10417	Factory settings via RS-232	Yes / No	UNSIGNED 16
1701	Reset factory default values	Yes / No	UNSIGNED 16

In order to enable the resetting procedure, parameter 10417 must be enabled.

#### Example 1 (enable resetting)

The resetting procedure via RS-232/RS-485 shall be enabled.

- Modbus address = 40000 + (Par. ID + 1) = 410418
- Modbus length = 1 (UNSIGNED 16)

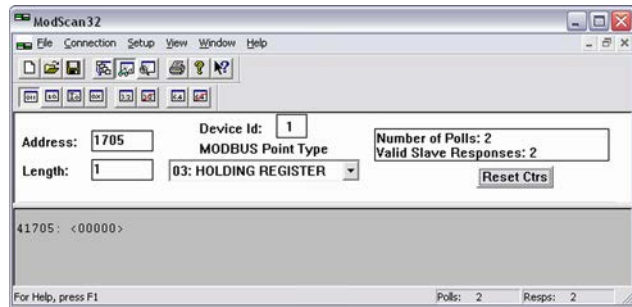

Fig. 273: Modscan32 at address 410418

1. Use the "display options" to set the value format to decimal.
2. Double-click the address to issue a Write Register command.
  - ⇒ Fig. 274 shows how the parameter is enabled using the ModScan32 Software. The value must be set to "1" to enable the parameter.

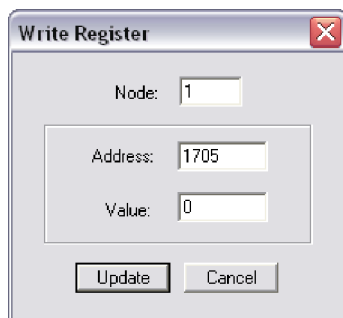

Fig. 274: Write register - enable the resetting procedure via RS-232/RS-485

### Example 2 (reset to default)

In order to reset the default values, parameter 1701 p. 92 must be enabled.

The default values shall be reset.

- Modbus address =  $40000 + (\text{Par. ID} + 1) = 41702$
- Modbus length = 1 (UNSIGNED 16)

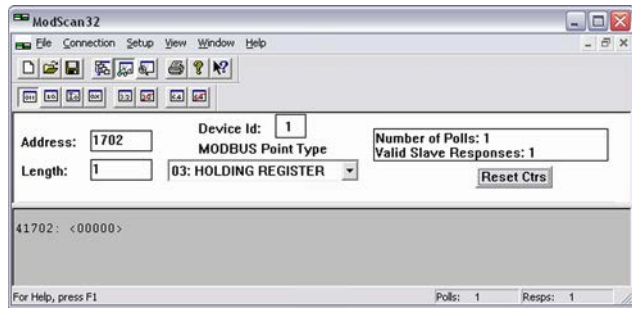

Fig. 275: Modscan32 at address 410418

1. Use the "display options" to set the value format to decimal.
2. Double-click the address to issue a Write Register command.

⇒ Fig. 276 shows how the parameter is enabled using the ModScan32 Software. The value must be set to "1" to enable the parameter.



Fig. 276: Write register - resetting the default values

### 6.6.3 Exception Responses

The Modbus protocol has multiple exception responses to show that a request could not be executed. Exception responses can be recognized if the response telegram contains the request function code with an offset of 128 (0x80 hex).

☞ "Modbus - exception responses" on page 520 explains possible reasons for an exception response that occurred.

Modbus exception responses		
Code	Name	Reason
01	ILLEGAL FUNCTION	The sent request function code is not supported by the Modbus protocol.
02	ILLEGAL ADDRESS	Permission to read/write the parameter is denied. The amount of requested registers is wrong to read/write this registers.
03	ILLEGAL DATA VALUE	The data value exceeds the min. and max. limitations of the parameter upon a write request. There is no parameter on the requested address.

Table 91: Modbus - exception responses



# 7 Interfaces And Protocols

## 7.1 Interfaces Overview

### Packages



The easYgen-3100/3200 controllers are available in different packages. The differences are listed below.

easYgen-3100/3200	Package P1	Package P2
Freely configurable PID controllers	-	3
External discrete inputs / outputs via CANopen (maximum)	16 / 16	32 / 32
External analog inputs / outputs via CANopen (maximum)	-	16 / 4

### Interfaces and protocols

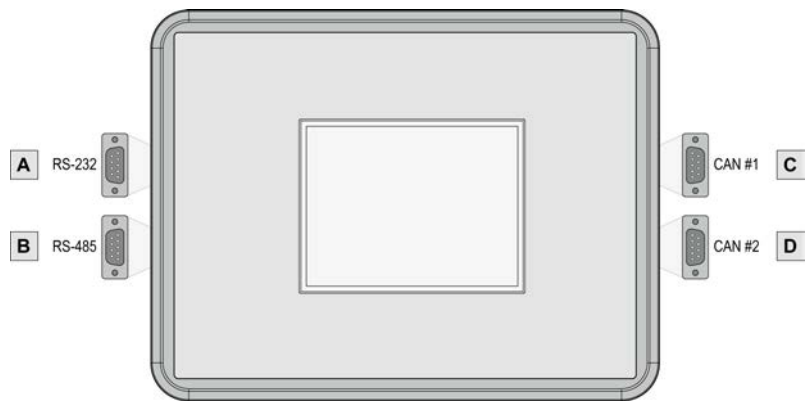

Fig. 277: easYgen-3200 interfaces

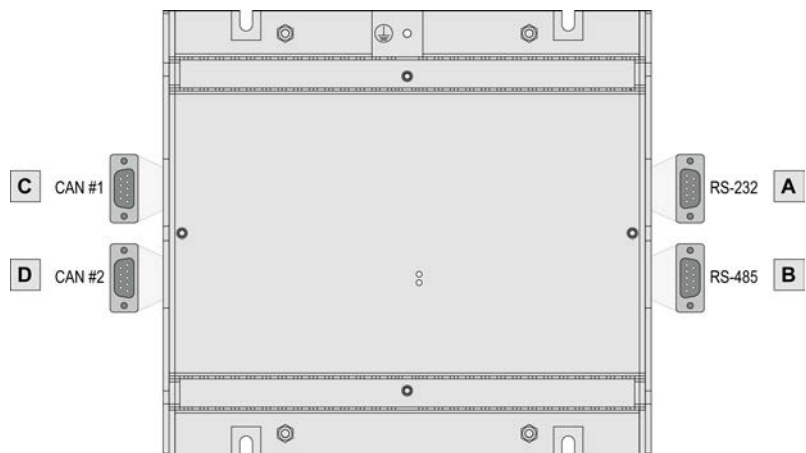

Fig. 278: easYgen-3100 interfaces

The easYgen-3100/3200 ( Fig. 278/ Fig. 277) provides the following interfaces, which are supporting different protocols.

Figure	Interface	Protocol
A	RS-232	Modbus; ToolKit
B	RS-485	Modbus
C	CAN bus #1	CANopen
D	CAN bus #2	CANopen; J1939

## 7.2 CAN Interfaces

### 7.2.1 CAN Interface 1 (Guidance level)

The CAN interface 1 is a freely configurable CANopen interface with 5 RPDOs (receive boxes), 5 TPDOs (send boxes) and 4 additional Server SDOs.

CAN interface 1 is also used for load sharing.

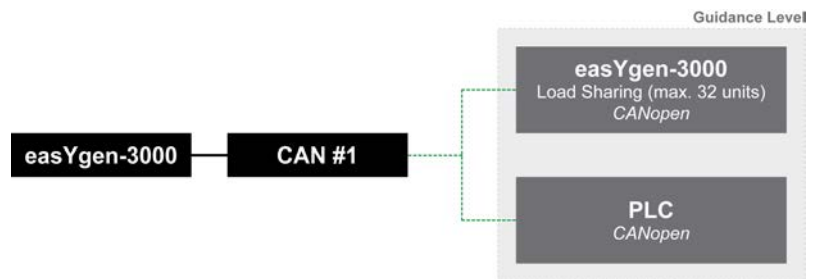

Fig. 279: CAN interface 1

### 7.2.2 CAN Interface 2 (Engine level)

The CAN interface 2 supports the CANopen and J1939 protocol simultaneously. It supports the connection of a wide range of engine control units (ECUs) and J1939 analog input extension modules, which comply with the J1939 standard (e.g. Axiomatic). CANopen extension modules are also supported.

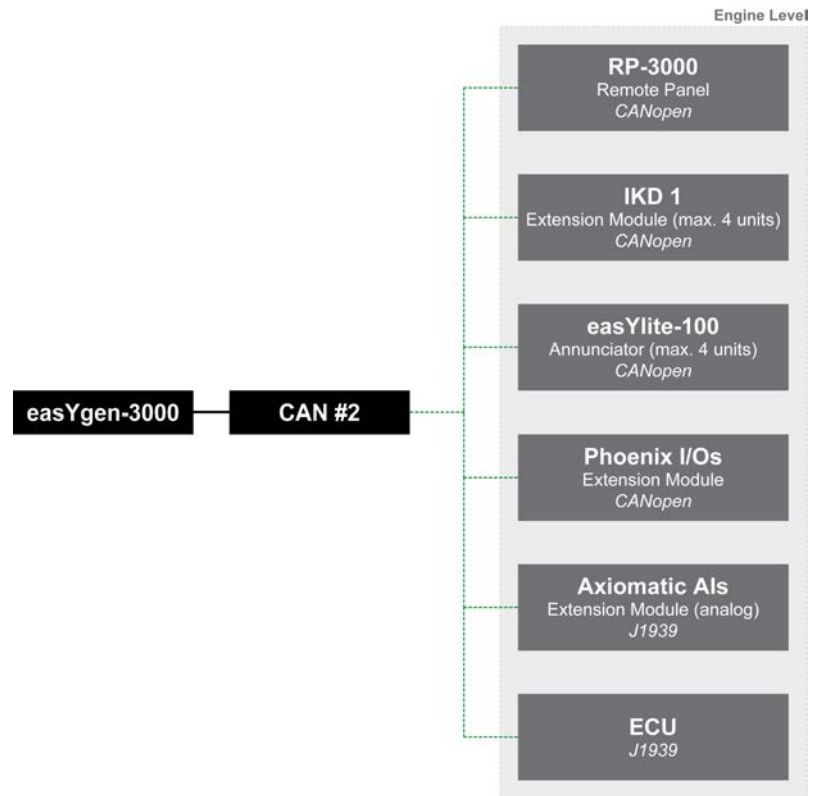

Fig. 280: CAN interface 2

CAN interface 2 is pre-configured for several expansion units. These include the I/O expansion boards Woodward IKD 1 and several combinations of the expansion boards of the Phoenix Inline Modular (IL) series.

It is possible to connect several combinations of up to four Woodward IKD 1s and Phoenix Inline Modular (IL) modules with up to

- **P1**: 16 discrete inputs/outputs.
- **P2**: 32 discrete inputs/outputs, 16 analog inputs, and 4 analog outputs.

## 7.3 Serial Interfaces

### 7.3.1 RS-232 Interface (Serial Interface 1)

A freely configurable RS-232 interface is provided to serve as a local service interface for configuring the unit and visualize measured data. It is possible to connect a modem for remote control and alarm signaling.

The serial interface 1 provides a Modbus as well as the Woodward ToolKit protocol.

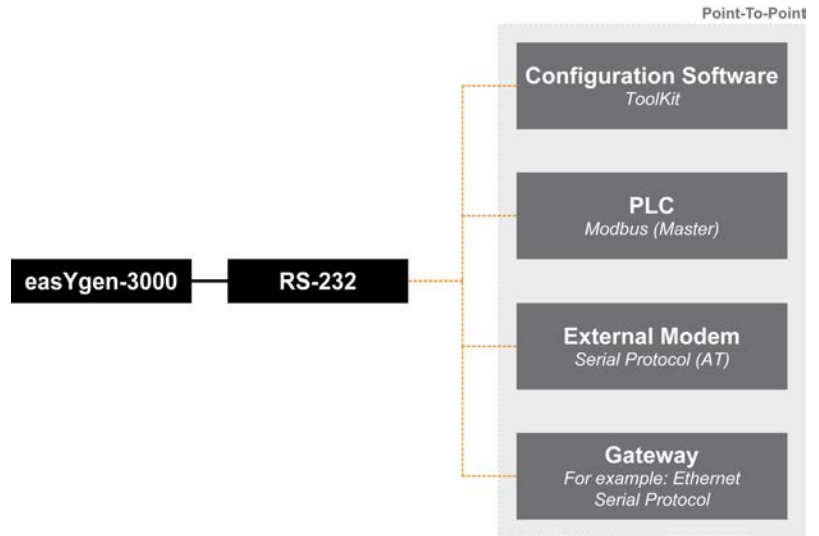

Fig. 281: RS-232 interface

### 7.3.2 RS-485 Interface (Serial Interface 2)

A freely configurable RS-485 Modbus RTU Slave interface is provided to add PLC connectivity. It is also possible to configure the unit, visualize measured data and alarm messages, and control the unit remotely.



Fig. 282: RS-485 interface

## 7.4 CANopen Protocol

CANopen is a communication protocol and device profile specification for embedded systems used in automation. The CANopen standard consists of an addressing scheme, several small communication protocols and an application layer defined by a device profile. The communication protocols have support for network management, device monitoring and communication between nodes, including a simple transport layer for message segmentation/ desegmentation.

### Protocol description

If a data protocol is used, a CAN message looks like this:

Byte 1	Byte 2	Byte 3	Byte 4	Byte 5	Byte 6	Byte 7	Byte 8
MUX	Data byte	Data byte	Data byte	Data byte	Data byte	Data byte	Internal

The MUX byte is counted up, the meaning of the data byte changes according to the value of the MUX byte.

In the protocol tables is listed which parameter at which MUX on which position is transmitted. The meaning of the parameter can be taken by means of the number of the parameter description ("CANopen Mapping parameter").

**Example**

MUX	Byte 2	Byte 3	Byte 4	Byte 5	Byte 6	Byte 7	Byte 8
1	118				147		Internal

In MUX 1 (byte 1 has got value 1) the value of parameter 118 is included in the byte 2 up to byte 5 (mains voltage 1-2). In byte 6 up to byte 7 the value of parameter 147 is included (mains frequency). Byte 8 includes internal definitions and can be ignored.

**Data format "Unsigned Integer"**

UNSIGNED type data has positive integers as values. The range is between 0 and  $2^n - 1$ . The data is shown by the bit sequence of length n.

- Bit sequence:  
 $b = b_0$  to  $b_{n-1}$
- Value shown:  
 $UNSIGNED_n(b) = b_{n-1} * 2^{n-1} + \dots + b_1 * 2^1 + b_0 * 2^0$



*Please note that the bit sequence starts on the left with the least significant byte.*

*Example: Value 266 = 10A hex of type UNSIGNED16 is transmitted on the bus in two octets, first 0A hex and then 01 hex.*

The following UNSIGNED data types are transmitted as follows:

Octet Number	1.	2.	3.	4.	5.	6.	7.	8.
UNSIGNED8	$b_7$ to $b_0$							
UNSIGNED16	$b_7$ to $b_0$	$b_{15}$ to $b_8$						
UNSIGNED24	$b_7$ to $b_0$	$b_{15}$ to $b_8$	$b_{23}$ to $b_{16}$					
UNSIGNED32	$b_7$ to $b_0$	$b_{15}$ to $b_8$	$b_{23}$ to $b_{16}$	$b_{31}$ to $b_{24}$				
UNSIGNED40	$b_7$ to $b_0$	$b_{15}$ to $b_8$	$b_{23}$ to $b_{16}$	$b_{31}$ to $b_{24}$	$b_{39}$ to $b_{32}$			
UNSIGNED48	$b_7$ to $b_0$	$b_{15}$ to $b_8$	$b_{23}$ to $b_{16}$	$b_{31}$ to $b_{24}$	$b_{39}$ to $b_{32}$	$b_{47}$ to $b_{40}$		
UNSIGNED56	$b_7$ to $b_0$	$b_{15}$ to $b_8$	$b_{23}$ to $b_{16}$	$b_{31}$ to $b_{24}$	$b_{39}$ to $b_{32}$	$b_{47}$ to $b_{40}$	$b_{55}$ to $b_{48}$	
UNSIGNED64	$b_7$ to $b_0$	$b_{15}$ to $b_8$	$b_{23}$ to $b_{16}$	$b_{31}$ to $b_{24}$	$b_{39}$ to $b_{32}$	$b_{47}$ to $b_{40}$	$b_{55}$ to $b_{48}$	$b_{63}$ to $b_{56}$

Table 92: Transfer syntax for data type UNSIGNEDn

**Data format "Signed Integer"**

SIGNED type data has integers as values. The range is between 0 and  $2^{n-1}$ . The data is shown by the bit sequence of length n.

- Bit sequence:  
b = b<sub>0</sub> to b<sub>n-1</sub>
- Value shown:  
SIGNEDn(b) = b<sub>n-2</sub> \* 2<sup>n-2</sup> + ... + b<sub>1</sub> \* 2<sup>1</sup> + b<sub>0</sub> \* 2<sup>0</sup>  
if b<sub>n-1</sub> = 0
- And with two's complement:  
SIGNEDn(b) = SIGNEDn(^b)-1  
if b<sub>n-1</sub> = 1



*Please note that the bit sequence starts on the left with the least significant byte.*

*Example: The value -266 = FEF6 hex of type SIGNED16 is transmitted in two octets, first F6 hex and then FE hex.*

Octet Number	1.	2.	3.	4.	5.	6.	7.	8.
SIGNED8	b <sub>7</sub> to b <sub>0</sub>							
SIGNED16	b <sub>7</sub> to b <sub>0</sub>	b <sub>15</sub> to b <sub>8</sub>						
SIGNED24	b <sub>7</sub> to b <sub>0</sub>	b <sub>15</sub> to b <sub>8</sub>	b <sub>23</sub> to b <sub>16</sub>					
SIGNED32	b <sub>7</sub> to b <sub>0</sub>	b <sub>15</sub> to b <sub>8</sub>	b <sub>23</sub> to b <sub>16</sub>	b <sub>31</sub> to b <sub>24</sub>				
SIGNED40	b <sub>7</sub> to b <sub>0</sub>	b <sub>15</sub> to b <sub>8</sub>	b <sub>23</sub> to b <sub>16</sub>	b <sub>31</sub> to b <sub>24</sub>	b <sub>39</sub> to b <sub>32</sub>			
SIGNED48	b <sub>7</sub> to b <sub>0</sub>	b <sub>15</sub> to b <sub>8</sub>	b <sub>23</sub> to b <sub>16</sub>	b <sub>31</sub> to b <sub>24</sub>	b <sub>39</sub> to b <sub>32</sub>	b <sub>47</sub> to b <sub>40</sub>		
SIGNED56	b <sub>7</sub> to b <sub>0</sub>	b <sub>15</sub> to b <sub>8</sub>	b <sub>23</sub> to b <sub>16</sub>	b <sub>31</sub> to b <sub>24</sub>	b <sub>39</sub> to b <sub>32</sub>	b <sub>47</sub> to b <sub>40</sub>	b <sub>55</sub> to b <sub>48</sub>	
SIGNED64	b <sub>7</sub> to b <sub>0</sub>	b <sub>15</sub> to b <sub>8</sub>	b <sub>23</sub> to b <sub>16</sub>	b <sub>31</sub> to b <sub>24</sub>	b <sub>39</sub> to b <sub>32</sub>	b <sub>47</sub> to b <sub>40</sub>	b <sub>55</sub> to b <sub>48</sub>	b <sub>63</sub> to b <sub>56</sub>

Table 93: Transfer syntax for data type INTEGER

## 7.5 J1939 Protocol

The J1939 protocol is using an extended CAN identifier and can be used via CAN bus interface parallel to the CANopen protocol and ToolKit. All devices connected to the CAN bus interface must use the same baud rate independent of the selected protocol.

Most of the J1939 data is standardized and has a SPN (Suspect Parameter Number), which describes the data (e.g. SPN 110 is representing the value of the current “Engine Coolant Temperature”). The SPNs are packed in different PGNs (Parameter Group Numbers). The PGN is a part of the CAN ID and is representing one CAN message (e.g. SPN 110 is packed in PGN 65263). J1939 defines several hundred SPNs. However, only a small part is important for most of the applications. For this reason only a part of the SPNs is supported by the J1939 devices and by the easYgen.

'SAE J1939' also allows manufacturer-specific data areas, so called proprietary data, which are not defined in the standard. In most cases, these proprietary data is used for remote control purposes (like start/stop, speed setpoint) of ECUs (Engine Control Unit). Some manufacturers also issue specific error messages using manufacturer-specific data. Besides important standardized data, the easYgen is also supporting some proprietary data for the different ECUs. Please refer to [Chapter 7.5.2 "Supported J1939 ECUs & Remote Control Messages"](#) on page 531 for details.

### 7.5.1 Displayed Messages (Visualization)

Visualization messages like "Engine Coolant Temperature" of a device (for example an ECU) are received on the CAN bus according to J1939 protocol and are shown on the device display and the ToolKit configuration software. In most cases the visualization works with standard messages.

The easYgen is able to display all values listed in the table ["Standard visualization messages"](#) on page 527 if they are supported by the connected device as well.

#### Diagnostic trouble codes (DM1/DM2)

In the J1939 status screen the first 10 active alarm messages (Active Diagnostic Trouble Codes - DM1) and the first 10 unacknowledged alarm messages (Previously Active Diagnostic Trouble Codes - DM2) with SPN, FMI, and OC are displayed.

The state of the lamps (amber/red) is always displayed.

- SPN (= Suspect Parameter Number) indicates the measured value that the alarm code is referring (e.g. SPN = 100 corresponds to oil pressure).
- FMI (= Failure Mode Indicator) specifies the alarm more precisely (e.g. FMI = 3 means: value is above predefined limits)
- OC (Occurrence Count) indicates how often an alarm occurred.



*Refer to the J1939 specification for a list of all SPNs.*

#### Standard visualization messages

SPN	PGN	Description	Resol.	Data range J1939	Index	Display with defective sensor	Display with missing sensor
52	65262	Engine intercooler temperature	1 °C	-40 to 210 °C	15217	32766 °C	32767 °C
91	61443	Throttle position	0.1 %	0 to 100 %	15207	3276.6 %	3276.7 %
92	61443	Load at current speed	1 %	0 to 250 %	15208	32766 %	32767 %
94	65263	Fuel delivery pressure	1 kPa	0 to 1000 kPa	15218	32766 kPa	32767 kPa
95	65276	Fuel filter difference pressure	1 kPa	0 to 500 kPa	15219	32766 kPa	32767 kPa
98	65263	Engine oil level	0.1 %	0 to 100 %	15210	3276.6 %	3276.7 %
100	65263	Engine oil pressure	1 kPa	0 to 1000 kPa	15205	32766 kPa	32767 kPa
101	65263	Crankcase pressure	1 kPa	-250 to 251 kPa	15220	32766 kPa	32767 kPa

## Interfaces And Protocols

J1939 Protocol > Displayed Messages (Visual...

SPN	PGN	Description	Resol.	Data range J1939	Index	Display with defective sensor	Display with missing sensor
102	65270	Boost pressure	1 kPa	0 to 500 kPa	15214	32766 kPa	32767 kPa
105	65270	Intake manifold temperature	1 °C	-40 to 210 °C	15215	32766 °C	32767 °C
106	65270	Turbo air inlet pressure	1 kPa	0 to 500 kPa	15221	32766 kPa	32767 kPa
107	65270	Air filter 1 difference pressure	0.01 kPa	0 to 12.5 kPa	15222	327.66 kPa	327.67 kPa
108	65269	Barometric pressure	0.1 kPa	0 to 125 kPa	15212	3276.6 kPa	3276.7 kPa
109	65263	Coolant pressure	1 kPa	0 to 500 kPa	15223	32766 kPa	32767 kPa
110	65262	Engine coolant temperature	1 °C	-40 to 210 °C	15202	32766 °C	32767 °C
111	65263	Coolant level	0.1 %	0 to 100 %	15206	3276.6 %	3276.7 %
127	65272	Transmission oil pressure	1 kPa	0 to 4000 kPa	15224	32766 kPa	32767 kPa
157	65243	Fuel rail pressure	0.1 MPa	0 to 251 MPa	15225	3276.6 MPa	3276.7 MPa
158	65271	Battery potential switched	0.1 V	0 to 3212.75 V	15312	3276.6 V	3276.7 V
171	65269	Ambient air temperature	0.1 °C	-273 to 1735 °C	15226	3276.6 °C	3276.7 °C
172	65269	Air inlet temperature	1 °C	-40 to 210 °C	15213	32766 °C	32767 °C
173	65270	Exhaust gas temperature	0.1 °C	-273 to 1735 °C	15216	3276.6 °C	3276.7 °C
174	65262	Fuel temperature	1 °C	-40 to 210 °C	15203	32766 °C	32767 °C
175	65262	Engine oil temperature	0.1 °C	-273 to 1735 °C	15309	3276.6 °C	3276.7 °C
176	65262	Turbo oil temperature	0.1 °C	-273 to 1735 °C	15227	3276.6 °C	3276.7 °C
177	65272	Transmission oil temperature	0.1 °C	-273 to 1735 °C	15228	3276.6 °C	3276.7 °C
183	65266	Fuel rate	0.1 l/h	0 to 3212.75 l/h	15307	3276.6 L/h	3276.7 L/h
190	61444	Engine speed	1 rpm	0 to 8031.875 rpm	15308	32766 rpm	32767 rpm
247	65253	Total engine hours <sup>1</sup>	1 h	0 to 210554060 h	15201	4294967294 h	4294967295 h
441	65164	Auxiliary temperature 1	1 °C	-40 to 210 °C	15229	32766 °C	32767 °C
442	65164	Auxiliary temperature 2	1 °C	-40 to 210 °C	15230	32766 °C	32767 °C
513	61444	Actual engine torque	1 %	-125 to 125 %	15209	32766 %	32767 %
1122	65191	Alternator bearing 1 temperature	1 °C	-40 to 210 °C	15231	32766 °C	32767 °C
1123	65191	Alternator bearing 2 temperature	1 °C	-40 to 210 °C	15232	32766 °C	32767 °C
1124	65191	Alternator winding 1 temperature	1 °C	-40 to 210 °C	15233	32766 °C	32767 °C
1125	65191	Alternator winding 2 temperature	1 °C	-40 to 210 °C	15234	32766 °C	32767 °C
1126	65191	Alternator winding 3 temperature	1 °C	-40 to 210 °C	15235	32766 °C	32767 °C
1131	65189	Intake manifold 2 temperature	1 °C	-40 to 210 °C	15236	32766 °C	32767 °C
1132	65189	Intake manifold 3 temperature	1 °C	-40 to 210 °C	15237	32766 °C	32767 °C
1133	65189	Intake manifold 4 temperature	1 °C	-40 to 210 °C	15238	32766 °C	32767 °C
1134	65262	Engine thermostat	0.1 %	0 to 100 %	15239	3276.6 %	3276.7 %



SPN	PGN	Description	Resol.	Data range J1939	Index	Display with defective sensor	Display with missing sensor
1135	65188	Engine oil temperature 2	0.1 °C	-273 to 1735 °C	15240	3276.6 °C	3276.7 °C
1136	65188	Engine ECU temperature	0.1 °C	-273 to 1735 °C	15241	3276.6 °C	3276.7 °C
1137	65187	Exhaust gas port 1 temperature	0.1 °C	-273 to 1735 °C	15242	3276.6 °C	3276.7 °C
1138	65187	Exhaust gas port 2 temperature	0.1 °C	-273 to 1735 °C	15243	3276.6 °C	3276.7 °C
1139	65187	Exhaust gas port 3 temperature	0.1 °C	-273 to 1735 °C	15244	3276.6 °C	3276.7 °C
1140	65187	Exhaust gas port 4 temperature	0.1 °C	-273 to 1735 °C	15245	3276.6 °C	3276.7 °C
1141	65186	Exhaust gas port 5 temperature	0.1 °C	-273 to 1735 °C	15246	3276.6 °C	3276.7 °C
1142	65186	Exhaust gas port 6 temperature	0.1 °C	-273 to 1735 °C	15247	3276.6 °C	3276.7 °C
1143	65186	Exhaust gas port 7 temperature	0.1 °C	-273 to 1735 °C	15248	3276.6 °C	3276.7 °C
1144	65186	Exhaust gas port 8 temperature	0.1 °C	-273 to 1735 °C	15249	3276.6 °C	3276.7 °C
1145	65185	Exhaust gas port 9 temperature	0.1 °C	-273 to 1735 °C	15250	3276.6 °C	3276.7 °C
1146	65185	Exhaust gas port 10 temperature	0.1 °C	-273 to 1735 °C	15251	3276.6 °C	3276.7 °C
1147	65185	Exhaust gas port 11 temperature	0.1 °C	-273 to 1735 °C	15252	3276.6 °C	3276.7 °C
1148	65185	Exhaust gas port 12 temperature	0.1 °C	-273 to 1735 °C	15253	3276.6 °C	3276.7 °C
1149	65184	Exhaust gas port 13 temperature	0.1 °C	-273 to 1735 °C	15254	3276.6 °C	3276.7 °C
1150	65184	Exhaust gas port 14 temperature	0.1 °C	-273 to 1735 °C	15255	3276.6 °C	3276.7 °C
1151	65184	Exhaust gas port 15 temperature	0.1 °C	-273 to 1735 °C	15256	3276.6 °C	3276.7 °C
1152	65184	Exhaust gas port 16 temperature	0.1 °C	-273 to 1735 °C	15257	3276.6 °C	3276.7 °C
1153	65183	Exhaust gas port 17 temperature	0.1 °C	-273 to 1735 °C	15258	3276.6 °C	3276.7 °C
1154	65183	Exhaust gas port 18 temperature	0.1 °C	-273 to 1735 °C	15259	3276.6 °C	3276.7 °C
1155	65183	Exhaust gas port 19 temperature	0.1 °C	-273 to 1735 °C	15260	3276.6 °C	3276.7 °C
1156	65183	Exhaust gas port 20 temperature	0.1 °C	-273 to 1735 °C	15261	3276.6 °C	3276.7 °C
1157	65182	Main bearing 1 temperature	0.1 °C	-273 to 1735 °C	15262	3276.6 °C	3276.7 °C
1158	65182	Main bearing 2 temperature	0.1 °C	-273 to 1735 °C	15263	3276.6 °C	3276.7 °C
1159	65182	Main bearing 3 temperature	0.1 °C	-273 to 1735 °C	15264	3276.6 °C	3276.7 °C
1160	65182	Main bearing 4 temperature	0.1 °C	-273 to 1735 °C	15265	3276.6 °C	3276.7 °C
1161	65181	Main bearing 5 temperature	0.1 °C	-273 to 1735 °C	15266	3276.6 °C	3276.7 °C
1162	65181	Main bearing 6 temperature	0.1 °C	-273 to 1735 °C	15267	3276.6 °C	3276.7 °C
1163	65181	Main bearing 7 temperature	0.1 °C	-273 to 1735 °C	15268	3276.6 °C	3276.7 °C
1164	65181	Main bearing 8 temperature	0.1 °C	-273 to 1735 °C	15269	3276.6 °C	3276.7 °C
1165	65180	Main bearing 9 temperature	0.1 °C	-273 to 1735 °C	15270	3276.6 °C	3276.7 °C
1166	65180	Main bearing 10 temperature	0.1 °C	-273 to 1735 °C	15271	3276.6 °C	3276.7 °C
1167	65180	Main bearing 11 temperature	0.1 °C	-273 to 1735 °C	15272	3276.6 °C	3276.7 °C
1172	65178	Turbo 1 compressor inlet temperature	0.1 °C	-273 to 1735 °C	15273	3276.6 °C	3276.7 °C

## Interfaces And Protocols

J1939 Protocol > Displayed Messages (Visual...

SPN	PGN	Description	Resol.	Data range J1939	Index	Display with defective sensor	Display with missing sensor
1173	65178	Turbo 2 compressor inlet temperature	0.1 °C	-273 to 1735 °C	15274	3276.6 °C	3276.7 °C
1174	65178	Turbo 3 compressor inlet temperature	0.1 °C	-273 to 1735 °C	15275	3276.6 °C	3276.7 °C
1175	65178	Turbo 4 compressor inlet temperature	0.1 °C	-273 to 1735 °C	15276	3276.6 °C	3276.7 °C
1176	65177	Turbo 1 compressor inlet pressure	1 kPa	-250 to 251 kPa	15277	32766 kPa	32767 kPa
1177	65177	Turbo 2 compressor inlet pressure	1 kPa	-250 to 251 kPa	15278	32766 kPa	32767 kPa
1178	65177	Turbo 3 compressor inlet pressure	1 kPa	-250 to 251 kPa	15279	32766 kPa	32767 kPa
1179	65177	Turbo 4 compressor inlet pressure	1 kPa	-250 to 251 kPa	15280	32766 kPa	32767 kPa
1180	65176	Turbo 1 inlet temperature	0.1 °C	-273 to 1735 °C	15281	3276.6 °C	3276.7 °C
1181	65176	Turbo 2 inlet temperature	0.1 °C	-273 to 1735 °C	15282	3276.6 °C	3276.7 °C
1182	65176	Turbo 3 inlet temperature	0.1 °C	-273 to 1735 °C	15283	3276.6 °C	3276.7 °C
1183	65176	Turbo 4 inlet temperature	0.1 °C	-273 to 1735 °C	15284	3276.6 °C	3276.7 °C
1184	65175	Turbo 1 outlet temperature	0.1 °C	-273 to 1735 °C	15285	3276.6 °C	3276.7 °C
1185	65175	Turbo 2 outlet temperature	0.1 °C	-273 to 1735 °C	15286	3276.6 °C	3276.7 °C
1186	65175	Turbo 3 outlet temperature	0.1 °C	-273 to 1735 °C	15287	3276.6 °C	3276.7 °C
1187	65175	Turbo 4 outlet temperature	0.1 °C	-273 to 1735 °C	15288	3276.6 °C	3276.7 °C
1203	65172	Engine auxiliary coolant pressure	1 kPa	0 to 1000 kPa	15289	32766 kPa	32767 kPa
1208	65170	Pre-filter oil pressure	1 kPa	0 to 1000 kPa	15290	32766 kPa	32767 kPa
1212	65172	Engine auxiliary coolant temperature	1 °C	-40 to 210 °C	15291	32766 °C	32767 °C
1382	65130	Fuel filter difference pressure	1 kPa	0 to 500 kPa	15292	32766 kPa	32767 kPa
1761	65110	Aftertreatment 1 Exhaust Tank1 Level	0.1%	0 to 100%	15313	3276.6%	3276.7%
1800	65104	Battery 1 temperature	1 °C	-40 to 210 °C	15293	32766 °C	32767 °C
1801	65104	Battery 2 temperature	1 °C	-40 to 210 °C	15294	32766 °C	32767 °C
1802	65189	Intake manifold 5 temperature	1 °C	-40 to 210 °C	15295	32766 °C	32767 °C
1803	65189	Intake manifold 6 temperature	1 °C	-40 to 210 °C	15296	32766 °C	32767 °C
2433	65031	Right exhaust gas temperature	0.1 °C	-273 to 1735 °C	15297	3276.6 °C	3276.7 °C
2434	65031	Left exhaust gas temperature	0.1 °C	-273 to 1735 °C	15298	3276.6 °C	3276.7 °C
2629	64979	Turbo 1 compr. outlet tmp.	0.1 °C	-273 to 1736 °C	15310	3276.6 °C	3276.7 °C
3031	65110	Aftertreatment 1 Exhaust Tank1 Temperature	1 °C	-40 to 210 °C	15314	32766 °C	32767 °C
3644	64914	Engine derate request	0.1%	0 to 100 %	15311	3276.6 %	3276.7 %
4367	64829	Aftertreatment 1 Exhaust Tank2 Level	0.1%	0 to 100%	15315	3276.6%	3276.7%
4368	64829	Aftertreatment 1 Exhaust Tank2 Temperature	1 °C	-40 to 210 °C	15316	32766 °C	32767 °C



<sup>1</sup> If the total engine hours sent by the ECU exceed 419,000 hrs, the display in the unit is not correct anymore

**Data transmission engine control unit (ECU)**

- If the sent values exceed the limits of the specification, the displayed value is not defined.
- If a value of the ECU is not sent or sent as not available or defective, the value will be displayed as indicated in the table before.

**Special Deutz EMR2/Volvo EDC4 messages**

Suspect parameter number	Parameter group number	Description
Engine stop	65301 (FF15h)	0 to 250

Please refer to the ECU manual for the engine specific stop codes.

**Special Scania S6 messages**

Suspect parameter number	Parameter group number	Description	Display in unit	Display in ToolKit
DLN2-Proprietary	65409 (FF81h)	Assessed messages:		
		■ Low engine oil level	No	No
		■ High engine oil level	Missing	Missing
		■ Low oil pressure	Yes	Yes
		■ High coolant temperature		

**7.5.2 Supported J1939 ECUs & Remote Control Messages**

The following table lists all ECUs, which are supported by the easYgen beyond the J1939 standard with the appropriate settings. We recommend device type (parameter 15102 ↗ p. 364) "Standard" for all ECUs, which are **not listed** here. All other parameters shall be clarified with the ECU manufacturer.

ECU	Device type (15102)	J1939 own address (15106)	Engine control address (15107)	SPN version (15103)	Comment
Standard ECUs	Standard	N/A	N/A	N/A	Please refer to ↗ Chapter 7.5.3 "Device Type Standard" on page 534 for more details.
Woodward EGS	EGS Woodward	234	0	N/A	
MTU ADEC ECU7	ADEC ECU7 MTU	1	128	N/A	The easYgen is connected with the SAM via CAN. The SAM communicates with the ADEC using an own bus.

ECU	Device type (15102)	J1939 own address (15106)	Engine control address (15107)	SPN version (15103)	Comment
Deutz EMR2 Volvo EDC4	EMR2 Deutz	3	0	Version 1	
Deutz EMR3 Deutz EMR4 (EDC 17)	Standard	3	0	N/A	
Volvo EMS2 Volvo EMS1 Volvo EDC3	EMS2 Volvo	17	0	N/A	The rated speed of the EMS1 and EDC3 cannot be switched via the easYgen.
Scania S6	S6 Scania	39	0	N/A	
MAN MFR/EDC7	MFR/EDC7 MAN	253	39	N/A	The easYgen is connected with the MFR via CAN. The MFR communicates with the EDC7 using an own bus.
SISU EEM2/3	EEM SISU	N/A	0 / (1)	N/A	
Cummins	Cummins	220	0	N/A	
MTU ADEC ECU8	ADEC ECU8 MTU	234	0	N/A	The easYgen is connected with the MTU system: ADEC ECU8 & SmartConnect.



*The addresses listed here are only valid, if the ECU is not configured to other values. In case of doubt, please check the corresponding settings of the ECU with the service tool.*

The following data is only transmitted to the corresponding ECU, if parameter "ECU remote controlled" is configured to "On", and parameter "Device type" is configured to one of the available ECU modes (if "Off" is configured, no J1939 remote control messages will be sent as well).



*Please note that some ECU manufacturers require that this functionality must be enabled first. In some cases, this is only possible by the manufacturer. Please consider this when ordering the ECU.*

Supported ECUs

- 1 - Woodward EGS
- 2 - Scania S6
- 3 - Deutz EMR2/EMR3 / Volvo EDC4
- 4 - Volvo EMS2
- 5 - Volvo EMS1/EDC3
- 6 - MTU ADEC ECU7
- 7 - MAN MFR/EDC7
- 8 - Standard
- 9 - SISU EEM 2/3
- 10 - Cummins
- 11 - MTU ADEC ECU8

Remote control parameter	1	2	3	4	5	6	7	8	9	10	11	Comment
Engine Start	No	Yes	No	Yes	Yes	Yes	Yes	No	No / Yes	Yes	Yes	If an engine start command is initiated by the easYgen, this information is transmitted in the form of a J1939 message bit to an ECU. If ignition speed is reached, this bit will be reset (LogicsManager command variable 03.02. "Starter").
Engine Stop	Yes	Yes	No	Yes	Yes	Yes	Yes	Yes	No / Yes	Yes	Yes	This J1939 bit information is set, if a "Stop" command in automatic or manual mode is present in the easYgen. The "Stop" bit information remains set, until ignition speed is fallen below. After ignition speed has been fallen below, the "Stop" bit will be reset (LogicsManager command variable 03.27. "Stopping solenoid").
Droop mode	Yes	Yes	No	Yes	Yes	Yes	Yes	Yes	Yes / Yes	Yes	No	This J1939 bit information is set, if a "Start" command in automatic or manual mode is initiated by the easYgen. The bit remains set until the engine has been stopped.  <b>Note</b> This message is only sent, if the LogicsManager output 00.25 "Frequency droop active" is TRUE.
Idle Mode	No	Yes	No <sup>1</sup>	Yes	Yes	No	No <sup>1</sup>	No <sup>1</sup>	No / No	Yes	Yes	This J1939 bit information is set, if "Idle" mode is active (LogicsManager command variable 04.15. "Idle run active" is TRUE).  The bit will be reset, if "Idle" mode is no longer active (LogicsManager command variable 04.15. "Idle run active" is FALSE).

Remote control parameter	1	2	3	4	5	6	7	8	9	10	11	Comment
50/60 Hz switch	Yes	Yes	No	Yes <sup>2</sup>	No	Yes	No <sup>1</sup>	No	No / No	Yes	Yes	The J1939 information for 50 or 60 Hz mode is sent to the ECU depending on the "Rated system frequency" parameter setting (1750 ↪ p. 95) within the easYgen .
Speed bias	Yes	Yes offset	Yes absolute	Yes offset	Yes	Yes absolute	Yes absolute	Yes absolute	Yes / Yes	Yes	Yes	Refer to parameter 5537 ↪ p. 367 for detailed information.
Preglow	No	No	No	Yes	Yes	No	No	No	No / No	No	No	This J1939 bit information is set, if the easYgen is in "Preglow" mode (LogicsManager command variable 03.04. "Preglow/Ignition" is TRUE).  The bit will be reset, if the "Preglow" phase has been expired or aborted.
Override	No	Yes	No	Yes	No	Yes	No	Yes	No / No	Yes	Yes	This J1939 bit information is set, if the easYgen is in critical mode (LogicsManager command variable 04.27. "Critical mode" is TRUE).  The bit will be reset, if the critical mode has been expired or aborted.
Engine power mode	No	No	No	No	No	No	No	No	No	No	Yes	This message is generated according to parameter "ECU power mode" (parameter 12939 ↪ p. 368).
Engine selected application	No	No	No	No	No	No	No	No	No	No	Yes	This message is generated according to parameter "ECU application" (parameter 4843 ↪ p. 368).



<sup>1</sup> Please contact manufacturer to clarify whether both frequencies (50/60 Hz) may be controlled by the speed bias.

<sup>2</sup> In case the rated speed of the easYgen and the ECU don't match, please make sure that the CAN connections works and change parameter 1750 ↪ p. 95 of the easYgen once.

### 7.5.3 Device Type Standard

#### General notes

If the used ECU is not specific listed in the chapter ↪ *Chapter 7.5 "J1939 Protocol" on page 526* (e.g. Deutz (EMR3 & EMR4), John Deere, Daimler, Perkins, Iveco, Caterpillar, Liebherr, etc.) we recommend to configure the "Device type" (parameter 15102 ↪ p. 364) to the setting "Standard". Visualization via J1939 is working

with every J1939 ECU. Concerning remote control most ECUs are also supporting the speed offset via J1939 standard message TSC1. This chapter supplies you with the details of the device type standard, to help you to clarify with the manufacturer how the ECU is supported.

**Displayed messages (visualization)**

In standard mode, the easYgen is able to display all values listed in the table [↗](#) “Standard visualization messages” on page 527 if they are supported by the connected ECU.

**Diagnostic trouble codes (DM1/DM2)**

In standard mode, the easYgen diagnostic messages DM1 (Active Diagnostic Trouble Codes) and DM2 (Previously Active Diagnostic Trouble Codes) are displayed. It is also possible to reset DM1 and DM2 failure codes via DM3 and DM11 messages.

**Remote control messages**

The following table shows the transmitted remote control messages. These messages are only transmitted if the parameter "ECU remote controlled" (parameter 15127 [↗](#) p. 366) is configured to "On".



*All listed messages are according to J1939 standard protocol.*

*Not all SPNs of the supported PGNs are listed here, in such case the easYgen transmits “Not available”.*

PGN		Acronym	Name	SPN	Description	Rate [ms]
Dec	Hex					
0	0000	TSC1	Torque/Speed Control 1	695	Engine Override Control Mode (fixed to “Speed Control”)	10
				696	Requested Speed Control Conditions (fixed to “Transient Optimized”)	
				897	Override Control Mode Priority (fixed to “Highest Priority”)	
				898	Engine Requested Speed/Speed Limit	
61441	F001	EBC1	Electronic Brake Controller 1	970	Engine Auxiliary Shutdown Switch	100
61470	F01E	GC2	Generator Control 2	3938	Generator Governing Bias	20
65029	FE05	GTACP	Generator Total AC Power	2452	Generator Total Real Power	100
64913	FD91	ACS	AC Switching Device Status	3545	Generator Circuit Breaker Status	250
				3546	Utility Circuit Breaker Status	
64971	FDCB	OHECS	Off-Highway Engine Control Selection	2881	Engine Alternate Droop Accelerator 1 Select	500

PGN		Acronym	Name	SPN	Description	Rate [ms]
Dec	Hex					
					<b>Notes</b> If droop shall be active (Logics-Manager 00.25 = TRUE) the easYgen is transmitting "Normal Droop" else "Alternate Droop Setting 1".	
65265	FEF1	CCVS	Cruise Control/Vehicle Speed	1237	Engine Shutdown Override Switch	100
59904	EA00	---	Request (specific)	247	Engine Total Hours of Operation (at PGN FEE5)	10,000
				---	DM11 Diagnostic Data Clear/Reset For Active DTCs (at PGN FED3)	
				---	DM3 Diagnostic Data Clear/Reset Of Previously Active DTCs (at PGN FECE)	
					<b>Notes</b> DM3 and DM11 are only transmitted if a reset is desired.	
59904	EA(FF)	---	Request (global)	---	DM2 Previously diagnostic trouble codes (at PGN FECB)	2,000
				---	DM11 Diagnostic Data Clear/Reset For Active DTCs (at PGN FED3)	
				---	DM3 Diagnostic Data Clear/Reset Of Previously Active DTCs (at PGN FECE)	
				441	Auxiliary Temperature 1 (at PGN FE8C)	
				442	Auxiliary Temperature 2 (at PGN FE8C)	
					<b>Notes</b> DM3 and DM11 are only transmitted if a reset is desired.	

**Configure J1939 addresses**

For the visualization the "J1939 own address" (parameter 15106 ↪ p. 365) and the "Engine control address" (parameter 15103 ↪ p. 366) are not relevant. But for remote control e.g. speed biasing these addresses must be configured correctly. Please refer to your ECU manual for the correct address. Normally the "Engine control address" (parameter 15103 ↪ p. 366) is "0" and the "J1939 own address" (parameter 15106 ↪ p. 365) is often "234" or "3".

**7.6 Modbus Protocol**

Modbus is a serial communications protocol published by Modicon in 1979 for use with its programmable logic controllers (PLCs). It has become a de facto standard communications protocol in industry, and is now the most commonly available means of connecting industrial electronic devices. The Woodward controller sup-



ports a Modbus RTU Slave module. This means that a Master node needs to poll the controller slave node. Modbus RTU can also be multi-dropped, or in other words, multiple Slave devices can exist on one Modbus RTU network, assuming that the serial interface is a RS-485.

Detailed information about the Modbus protocol is available on the following website:

- <http://www.modbus.org/specs.php>

There are also various tools available on the internet. We recommend using ModScan32 which is a Windows application designed to operate as a Modbus Master device for accessing data points in a connected Modbus Slave device. It is designed primarily as a testing device for verification of correct protocol operation in new or existing systems.

A trial version download is available from the following website:

- <http://www.win-tech.com/html/modscan32.htm>

**Address range**

The controller Modbus Slave module distinguishes between visualization data and configuration & remote control data. The different data is accessible over a split address range and can be read via the "Read Holding Register" function.

Furthermore, controller parameters and remote control data can be written with the "Preset Single Registers" function or "Preset Multiple Registers" ( Fig. 283)

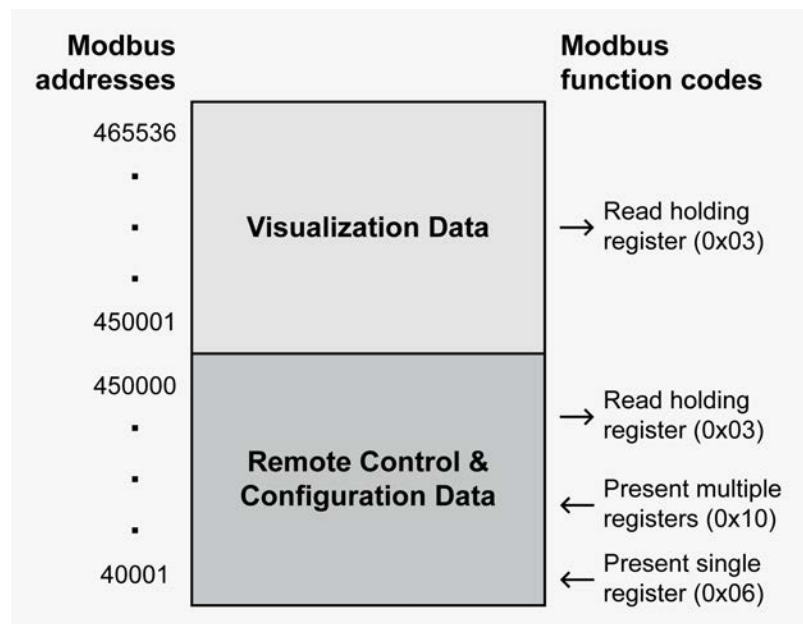

Fig. 283: Address range



All addresses in this document comply with the Modicon address convention. Some PLCs or PC programs use different address conventions depending on their implementation. Then the address must be increased and the leading 4 may be omitted.

Please refer to your PLC or program manual for more information. This determines the address sent over the bus in the Modbus telegram. The Modbus starting address 450001 of the visualization data may become bus address 50000 for example.

**Visualization**

The visualization over Modbus is provided in a very fast data protocol where important system data like alarm states, AC measurement data, switch states and various other informations may be polled.

According to the Modbus addressing range, the visualization protocol can be reached on addresses starting at 450001. On this address range it is possible to do block reads from 1 up to 128 Modbus registers at a time.

Modbus read addresses	Description	Multiplier	Units
450001	Protocol-ID, always 5010		--
450002	Scaling Power (16 bits) Exponent 10x W (5;4;3;2)		
.....	.....	.....	.....
.....	.....	.....	.....
.....	.....	.....	.....
.....	.....	.....	.....
450445	Total engine hours (j1939-HOURS)	1	h

Table 94: Address range block read



“Address range block read” on page 538 is only an excerpt of the data protocol. It conforms to the data protocol 5010.

Refer to Chapter 9.2.3.1 “Protocol 5010 (Basic Visualization)” on page 626 for the complete protocol.

The easYgen has an additional combined CANopen/Modbus protocol. Refer to Chapter 9.2.1.1 “Data Protocol 5003 (Basic Visualization)” on page 563 for the complete protocol.

The following ModScan32 screenshot shows the configurations made to read the visualization protocol with a block read of 128 registers.

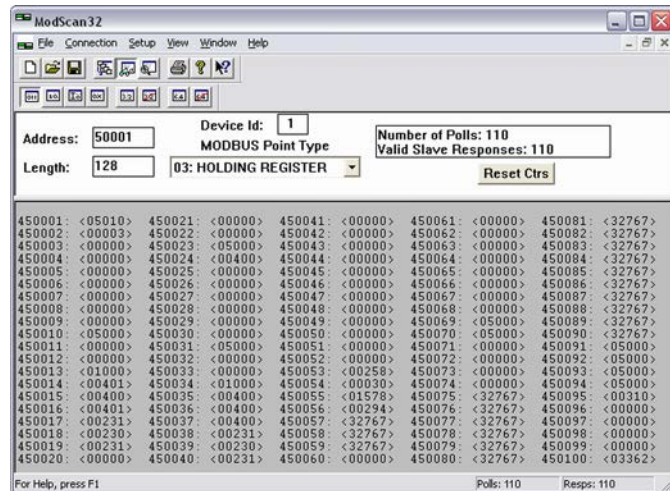

Fig. 284: Visualization configurations

### Configuration

The Modbus interface can be used to read/write parameters. According the Modbus addressing range for the configuration addresses, the range starts at 40001 and ends at 450000. You can always access only one parameter of the system in this address range. The Modbus address can be calculated depending on the parameter ID as illustrated below:

	Parameter ID < 10000	Parameter ID >= 10000
Modbus address =	40000 + (Par. ID+1)	400000 + (Par. ID+1)

Table 95: Address calculation

Block reads in this address range depend on the data type of the parameter. This makes it important to set the correct length in Modbus registers which depends on the data type (UNSIGNED 8, INTEGER 16, etc.).

Refer to [“Data types” on page 539](#) for more information.

Types	Modbus registers
UNSIGNED 8	1
UNSIGNED 16	1
INTEGER 16	1
UNSIGNED 32	2
INTEGER 32	2
LOGMAN	7
TEXT/X	X/2

Table 96: Data types



The Modbus RTU response time can increase under certain conditions:

- Display refresh of easYgen-3200 without CAN (J1939 protocol) connected -> max. 2 seconds
- Display refresh of easYgen-3200 with CAN (J1939 protocol) connected -> max. 3 seconds



Woodward recommends to make a break time of 10 ms after receiving the data of the last Modbus request.

## 7.7 Load Sharing

### General information

The maximum number of participating easYgen-3000 Series devices for load sharing is 32. The CANopen bus load increases with the number of units participating in load sharing.

The following parameters affect the bus load:

- Number of CAN participants
- Baud rate
- Transfer rate of load share messages
- Visualization

We recommend to consider whether all data has to be sent on the CAN bus when planning the CAN bus. It is also possible to send visualization data via RS-485 for example.

### Measures to reduce the bus load

If you need to reduce the bus load of the load share CAN bus, the following measures may be used:

- Increase the baud rate (parameter 3156 ↪ p. 353) under consideration of the bus length (refer to ↪ "Maximum CAN bus length" on page 81).
- Reduce the transfer rate of the load share message (parameter 9921 ↪ p. 369).
- Reduce the transfer rate of the visualization message, i.e. the event timer (parameter 9604 ↪ p. 360).
- Disable the transmission visualization data on the CAN bus and use the RS-485 interface to transmit visualization data.
- Disable SYNC message (parameter 9100 ↪ p. 354) and/or TIME message (parameter 9101 ↪ p. 354) and/or the producer heartbeat time SYNC message (parameter 9120 ↪ p. 354), if possible.

### Load diagnosis

Multiple units on the CAN bus may cause a high bus load depending on the used protocols and baud rate.

The easYgen provides a diagnosis screen to monitor the actual load on the CAN bus.

- ➔ To access the screen navigate to "Miscellaneous"
  - ➔ CAN Load diagnostic".

This screen provides information about the total CAN bus load as well as the CANopen and J1939 bus load on CAN bus 1 and 2. The total CAN bus load is the sum of the message load on CAN bus 1 and 2. 22 messages on the CAN buses within 20 ms correspond with 100 % load.

If more than 21 messages are sent within 20 ms, the logical command variable "08.20 CAN bus overload" will be enabled and the busses will be disabled consecutively starting with the last in the list (CAN1 bus load J1939) until the load falls below 22 messages per 20 ms.

The reconnecting of the busses is performed in the opposite order starting with the first in the list (CAN2 bus load CANopen). The easYgen also provides a monitoring function for initiating dedicated actions in case the CAN bus load is exceeded (refer to [Chapter 4.4.6.3 "CAN Bus Overload" on page 201](#) for detailed information).

**Multi-master principle**

It is important to know that the load share and load-dependent start/stop functionality is subject to a multi-master principle. This means that there is no dedicated master and slave function. Each easYgen decides for itself how it has to behave.

The benefit is that there is no master control, which may cause a complete loss of this functionality in case it fails. Each control is also responsible for controlling common breakers like a mains circuit or generator group breaker.

**Load share monitoring**

The easYgen provides monitoring functions for load sharing:

■ **Multi-unit parameter alignment**

The multi-unit parameter alignment functionality requires that the relevant parameters are all configured identically at all participating units. For additional information refer to [Chapter 4.4.6.11 "Multi-Unit Parameter Alignment" on page 209](#).

■ **Multi-unit missing members**

The multi-unit missing members monitoring function checks whether all participating units are available (sending data on the load share line). For additional information refer to [Chapter 4.4.6.12 "Multi-Unit Missing Members" on page 211](#).

**Load share parameters**

The following parameters are available for configuring the CAN bus interfaces. Refer to [Chapter 4.6.3 "Load Share Parameters" on page 369](#) for detailed information.

ID	Text	Setting range	Default value
9923	Load share Interface	CAN 1 / Off	CAN 1
9921	Transfer rate LS fast message	0.10 to 0.30 s	0.10 s
9920	Load Share CAN-ID	2xx Hex / 3xx Hex / 4xx Hex / 5xx Hex	5xx Hex



*Woodward recommends to configure the Node-IDs (parameter 8950 & p. 353) for units, which participate in load sharing, as low as possible to facilitate establishing of communication.*

## 8 Technical Specifications

### 8.1 Technical Data

#### Product label

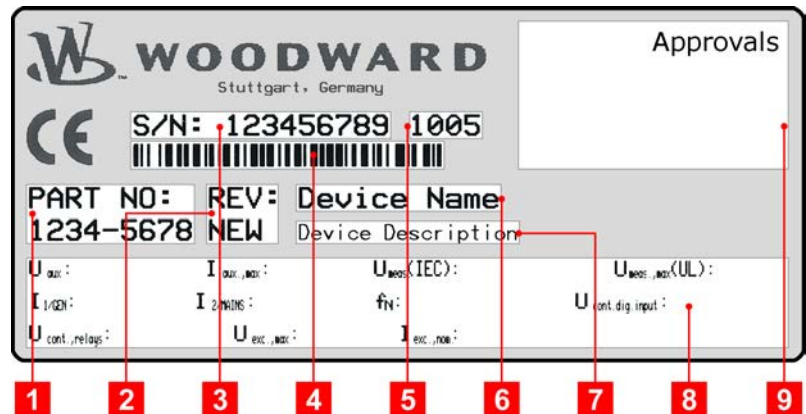

Fig. 285: Product label

1	P/N	Item number
2	REV	Item revision number
3	S/N	Serial number (numerical)
4	S/N	Serial number (barcode)
5	S/N	Date of production (year-month)
6	Type	Description (short)
7	Type	Description (long)
8	Details	Technical data
9	Approval	Approvals

#### 8.1.1 Measuring Values

##### Voltages

<b>Measuring voltage</b> $\Delta$ / $\Delta$	<b>120 V</b>	
Rated value ( $V_{rated}$ )		69/120 Vac
Maximum value ( $V_{max}$ )		max. 86/150 Vac
Rated voltage phase – ground		150 Vac
Rated surge voltage ( $V_{surge}$ )		2.5 kV
<b>Measuring voltage</b> $\Delta$ / $\Delta$	<b>480 V</b>	
Rated value ( $V_{rated}$ )		277/480 Vac
Maximum value ( $V_{max}$ )		max. 346/600 Vac
Rated voltage phase – ground		300 Vac
Rated surge voltage ( $V_{surge}$ )		4.0 kV
Linear measuring range		$1.25 \times V_{rated}$

## Technical Specifications

### Technical Data > Inputs/Outputs

Measuring frequency		50/60 Hz (30.0 to 85.0 Hz)
Input resistance per path	120 V	0.498 MΩ
	480 V	2.0 MΩ
Maximum power consumption per path		< 0.15 W

### Currents

Measuring inputs		Galvanically isolated
Measuring current	[1] Rated value ( $I_{rated}$ )	.. /1 A
	[5] Rated value ( $I_{rated}$ )	.. /5 A
Linear measuring range	Generator	$3.0 \times I_{rated}$
	Mains/ground current	approx. $1.5 \times I_{rated}$
Maximum power consumption per path	< 0.15 VA	
Rated short-time current (1 s)	[1]	$50.0 \times I_{rated}$
	[5]	$10.0 \times I_{rated}$

### 8.1.2 Ambient Variables

Power supply	12/24 Vdc (8 to 40.0 Vdc)
Intrinsic consumption	
Degree of pollution	2
Maximum elevation	2,000 m ASL
Insulation voltage (continuously)	40 Vdc
Insulation test voltage (1s)	100 Vdc
Overvoltage ( $\leq 2$ min)	80 Vdc
Reverse voltage protection	Over the full supply range
Input capacitance	4,300 $\mu$ F
Unit Power Supply	Negative potential or positive potential grounded

### 8.1.3 Inputs/Outputs

#### Discrete inputs 'DI x'

Discrete inputs	Galvanically isolated
Input range (Vcont. dig. input)	Rated voltage 12/24 Vdc (8 to 40.0 Vdc)
Input resistance	approx. 20 kΩ



**Discrete outputs 'R x' (relay outputs)**

Discrete/relay outputs	Potential free Configurable via Logics-Manager	Galvanically isolated
Contact material		AgCdO
General purpose (GP) ( $V_{cont, relays}$ )	AC	2.00 Aac@250 Vac
	DC	2.00 Adc@24 Vdc
		0.36 Adc@125 Vdc
		0.18 Adc@250 Vdc
Pilot duty (PD) ( $V_{cont, relays}$ )	AC	B300
	DC	1.00 Adc@24 Vdc
		0.22 Adc@125 Vdc
		0.10 Adc@250 Vdc

**Analog inputs 'AI 01-03'**

Analog inputs	FlexIn™	Freely scalable
Maximum permissible voltage against PE (Ground)		9 V
Resolution		11 Bit
0/4 to 20 mA input	Internal load	50 Ω
0 to 500 Ω input	Load current	≤ 2.3 mA

**Analog outputs 'AO 01-02'**

Analog outputs		Galvanically isolated
At rated output		Freely scalable
Insulation voltage (continuously)		100 Vac
Insulation test voltage (1 s)		500 Vac
Versions		±10 Vdc, ±20 mA, PWM
Resolution	±20 mA outputs Configured to ±20 mA	12 bit
	±20 mA outputs Configured to 0 to 20 mA	11 bit
0 to 20 mA output	Load	≤ 500 Ω
±10 V output	Internal resistance	approx. 500 Ω

## Auxiliary excitation (D+) input/output

Auxiliary excitation (D+) input/output	Galvanically isolated
Output current	approx. 120 mA@12/24 Vdc
Voltage monitoring range (input)	8 to 40.0 Vdc

## Magnetic pickup input

Magnetic pickup input	Capacitively isolated
Input impedance	min. approx. 17 kΩ
Input voltage	Refer to <a href="#">☞ "Magnetic pickup input"</a> on page 546

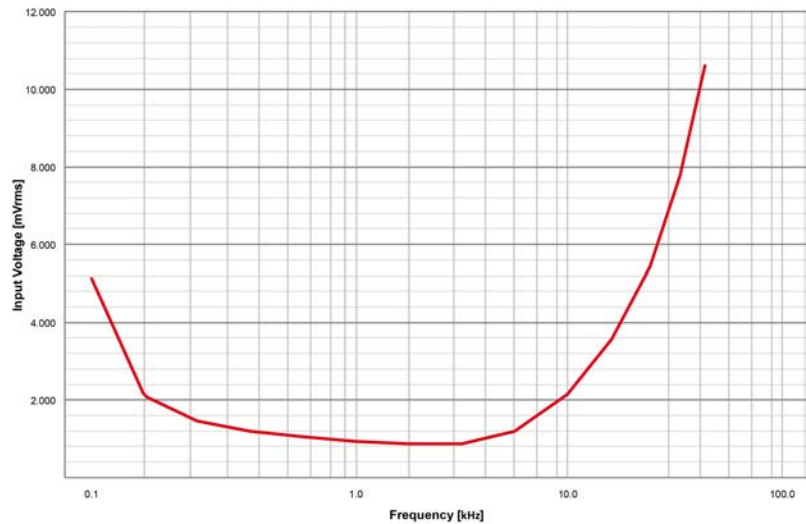

Fig. 286: MPU - characteristic

## 8.1.4 Interface

### RS-232 interface

RS-232 interface	Galvanically isolated
Insulation voltage (continuously)	100 Vac
Insulation test voltage (1 s)	500 Vac
Version	RS-232 Standard

### RS-485 interface

RS-485 interface	Galvanically isolated
Insulation voltage (continuously)	100 Vac
Insulation test voltage (1 s)	500 Vac
Version	RS-485 Standard

### CAN bus interface

CAN bus interface	Galvanically isolated
Insulation voltage (continuously)	100 Vac
Insulation test voltage (1 s)	500 Vac
Version	CAN bus
Internal line termination	Not available

### 8.1.5 Battery

Type	Lithium
Life span (operation without power supply)	approx. 5 years
Battery field replacement	Not allowed

### 8.1.6 Housing

#### Housing type

Type	Plastic	easYpack
	Sheet metal	Custom
Dimensions (W × H × D)	Plastic	282 × 217 × 99 mm
	Sheet metal	250 × 227 × 84 mm
Front cutout (W × H)	Plastic	249 [+1.1] × 183 [+1.0] mm
Wiring	Screw-plug-terminals	2.5 mm <sup>2</sup>
Recommended locked torque	4 inch pounds / 0.5 Nm Use 60/75 °C copper wire only Use class 1 wire only or equivalent	
Weight	Plastic	approx. 1,850 g
	Sheet metal	approx. 1,750 g

#### Protection

Protection system	Plastic	IP54 in the front with clamp fasteners
		IP66 in the front with screw kit
		IP20 on the rear side
	Sheet metal	IP20
Front foil (plastic housing)		Insulating surface

### 8.1.7 Approvals

EMC test (CE)	Tested according to applicable EN guidelines
Listings	CE marking UL, Ordinary Locations, File No.: 231544 UL recognized component, category FTPM2/8, File No.: E347132 cUL: easYgen-3100 only; CSA BDEW (Dynamic mains stabilization) VDE-AR-N 4105 (Mains decoupling and single failure proof feature)

Marine	Type approval	Lloyds Register (LR)
		American Bureau of Shipping (ABS)

8.1.8 Generic Note

Accuracy	Referred to full scale value
----------	------------------------------

8.2 Environmental Data

Vibration

Frequency range - sine sweep	5 Hz to 100 Hz
Acceleration	4 G
Standards	EN 60255-21-1 (EN 60068-2-6, Fc)
	EN 60255-21-3
	Lloyd's Register, Vibration Test2
	SAEJ1455 Chassis Data
Frequency range - random	10 Hz to 500 Hz
Power intensity	0.015 G <sup>2</sup> /Hz
RMS value	1.04 Grms
Standards	MIL-STD 810F, M514.5A, Cat.4,
	Truck/Trailer tracked-restrained
	Cargo, Fig. 514.5-C1

Shock

Shock	40 G, Saw tooth pulse, 11 ms
Standards	EN 60255-21-2
	MIL-STD 810F, M516.5, Procedure 1

Temperature

Cold, Dry Heat (storage)	-30 °C (-22 °F) / 80 °C (176 °F)
Cold, Dry Heat (operating)	-20 °C (-4 °F) / 70 °C (158 °F)
Standards	IEC 60068-2-2, Test Bb and Bd
	IEC 60068-2-1, Test Ab and Ad

Humidity

Humidity	60 °C, 95 % RH, 5 days
Standards	IEC 60068-2-30, Test Db

**Marine environmental categories**

Marine environmental categories	Lloyd's Register of Shipping (LRS): ENV1, ENV2, ENV3 and ENV4
---------------------------------	--

**8.3 Accuracy**

Measuring value	Display	Accuracy	Measuring start	Notes
<b>Frequency</b>				
Generator	15.0 to 85.0 Hz	0.1% (of 85 Hz)	5% (of PT secondary voltage setting) <sup>1</sup>	
Mains	30.0 to 85.0 Hz			
<b>Voltage</b>				
Wye generator / mains / busbar	0 to 650 kV	1% (of 150/600 V) <sup>2</sup> Class 1	1.5% (of PT secondary voltage setting) <sup>1</sup>	
Delta generator / mains / busbar			2% (of PT secondary voltage setting) <sup>1</sup>	
<b>Current</b>				
Generator	0 to 32,000 A	1% (of 1.3/6.5 A) <sup>3</sup> Class 1	1% (of 1.3/6.5 A) <sup>3</sup>	
Max. value				
Mains/ground current				
<b>Real power</b>				
Actual total real power value	-2 to 2 GW	2% (of 150/600 V x 1.3/6.5 A) <sup>2/3</sup>	Measuring starts with detecting the zero passage of current/voltage	
<b>Reactive power</b>				
Actual value in L1, L2, L3	-2 to 2 Gvar	2% (of 150/600 V x 1.3/6.5 A) <sup>2/3</sup>	Measuring starts with detecting the zero passage of current/voltage	
<b>Power factor</b>				
Actual value power factor L1	lagging 0.00 to 1.00 to leading 0.00	2%	2% (of 1.3/6.5 A) <sup>3</sup>	1.00 is displayed for measuring values below the measuring start
<b>Miscellaneous</b>				
Real energy	0 to 4,200 GWh		0.36% (of 1.3/6.5 A) <sup>3</sup>	Not calibrated
Operating hours	Max. 1 × 10 <sup>6</sup> h			
Maintenance call hours	0 to 9,999 h			
Maintenance call days	0 to 999 d			
(Engine) Start counter	0 to 65,535			
Battery voltage	8 to 40 V	1% (of 24 V)		
Auxiliary excitation (D+) input/output		1 %		
Pickup speed	f <sub>rated</sub> +/- 40 %			

## Technical Specifications

### Accuracy

Measuring value	Display	Accuracy	Measuring start	Notes
Phase angle	-180 to 180°		1.25% (of PT secondary volt. setting)	180° is displayed for measuring values below measuring start
<b>Analog inputs</b>				
0 to 500 Ohms	Freely scalable	1% / 2.5% <sup>4</sup> (of 500 Ohms)		For resistive sensors e.g., VDO sensors 0 to 180/360 Ohms
0 to 20 mA	Freely scalable	1.2% / 2.5% <sup>4</sup> (of 20 mA)		



<sup>1</sup> Setting of the parameter for the PT secondary rated voltage

<sup>2</sup> Depending on the used measuring inputs (120/480 V)

<sup>3</sup> Depending on the CT input hardware (1/5 A) of the respective unit

<sup>4</sup> For two-pole senders only / for single-pole senders and a combination of single- and two-pole sensors

### Reference conditions



The reference conditions for measuring the accuracy are listed below.

Input voltage	Sinusoidal rated voltage
Input current	Sinusoidal rated current
Frequency	Rated frequency +/- 2 %
Power supply	Rated voltage +/- 2 %
Power factor (cos φ)	1.00
Ambient temperature	23 °C +/- 2 K
Warm-up period	20 minutes

## 9 Appendix

### 9.1 Characteristics

#### 9.1.1 Triggering Characteristics

Time-dependent overshoot monitoring

This triggering characteristic is used for time-dependent overcurrent monitoring.

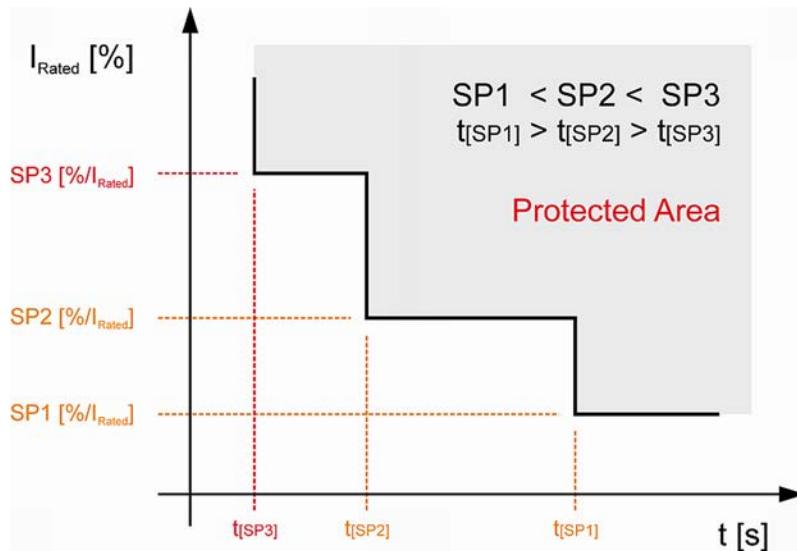

Fig. 287: Three-level time-dependent overshoot monitoring

**Two-level overshoot monitoring**

This triggering characteristic is used for generator, mains and battery overvoltage, generator and mains overfrequency, overload IOP and MOP and engine overspeed monitoring.

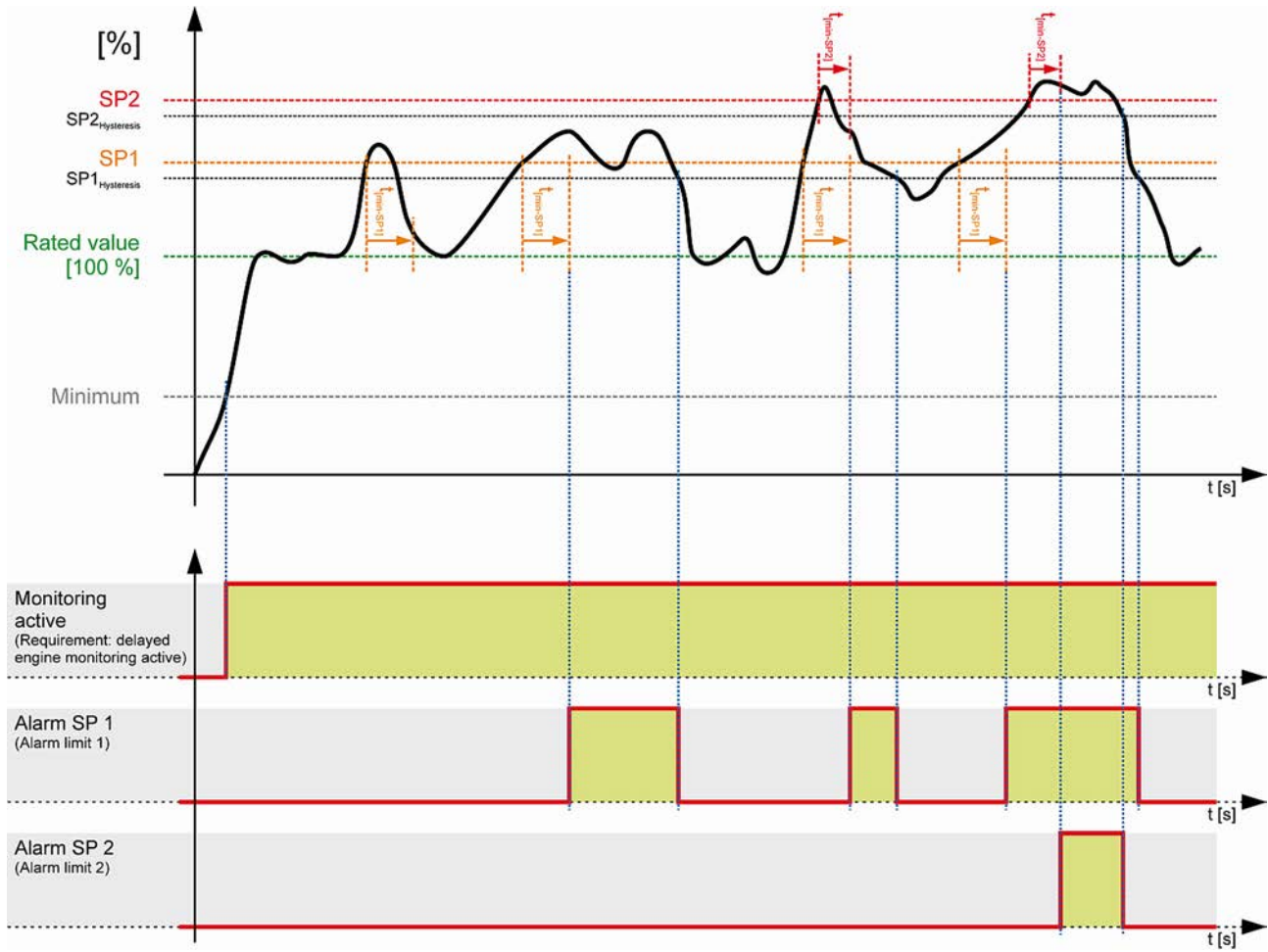

Fig. 288: Two-level overshoot monitoring



**Two-level undershoot monitoring**

This triggering characteristic is used for generator, mains and battery undervoltage, generator and mains underfrequency, and engine underspeed monitoring.

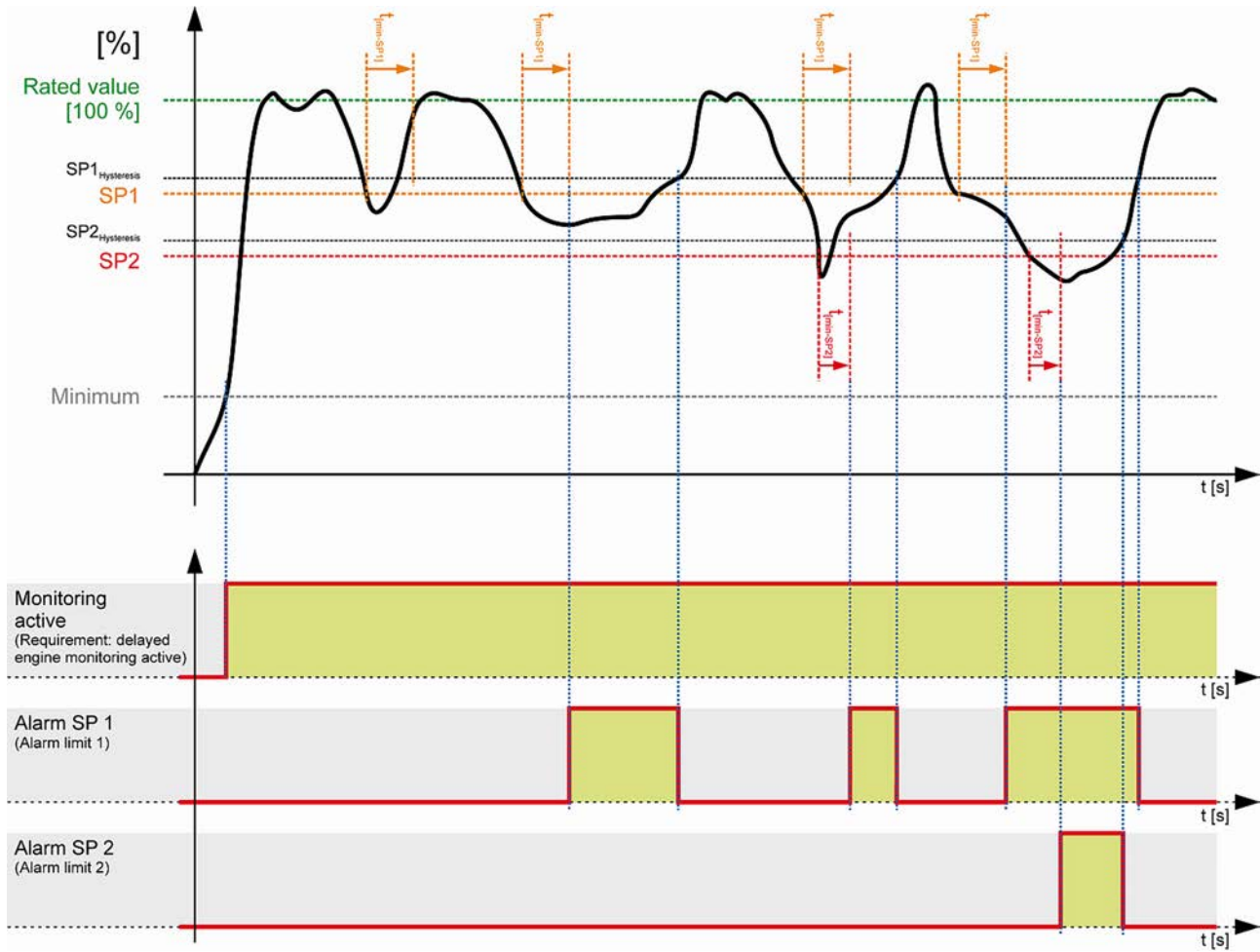

Fig. 289: Two-level undershoot monitoring

**Two-level reversed/reduced load monitoring**

This triggering characteristic is used for generator reversed/reduced load monitoring.

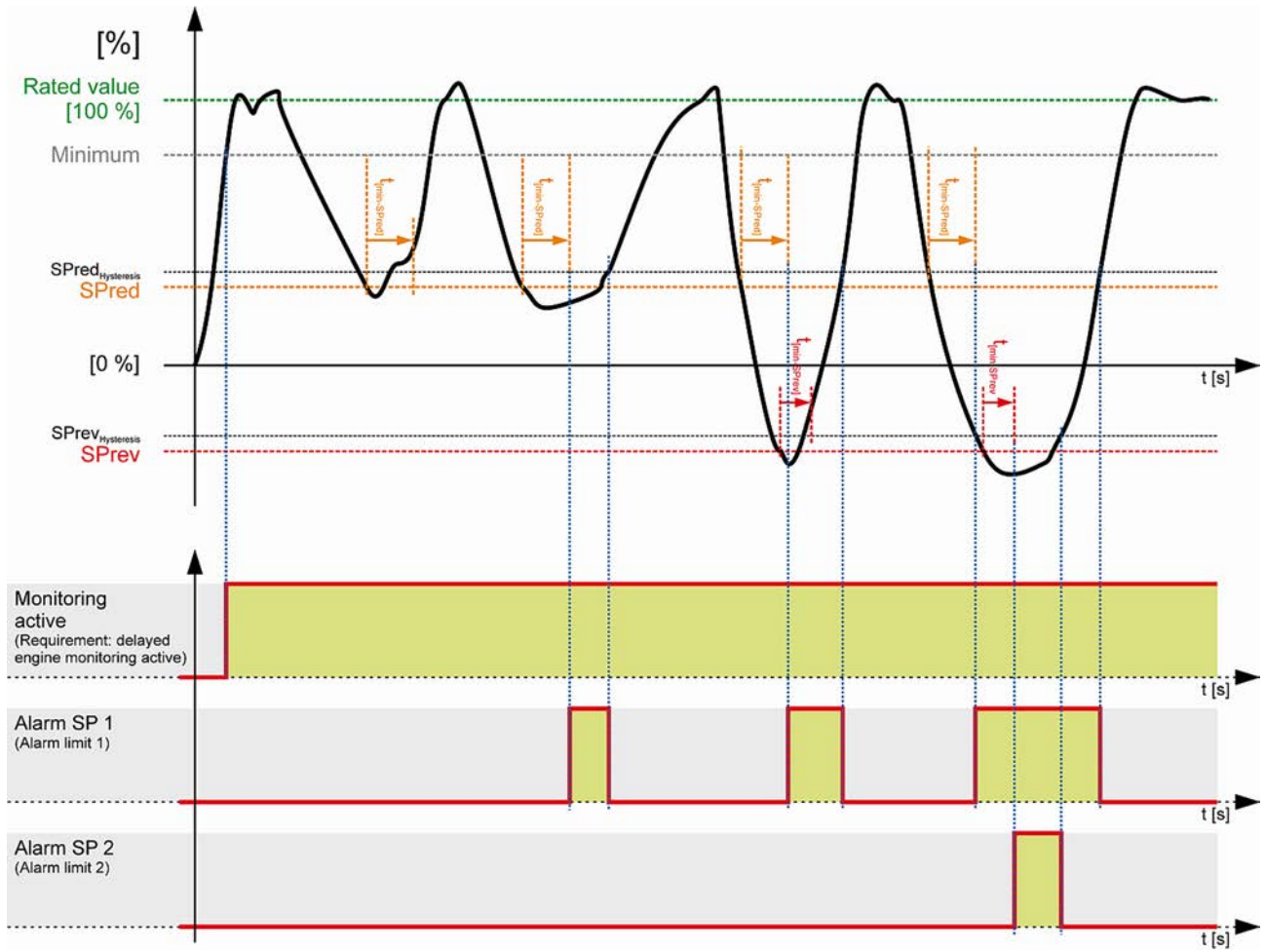

Fig. 290: Two-level reversed/reduced load monitoring

**Two-level unbalanced load monitoring**

This triggering characteristic is used for generator unbalanced load monitoring.

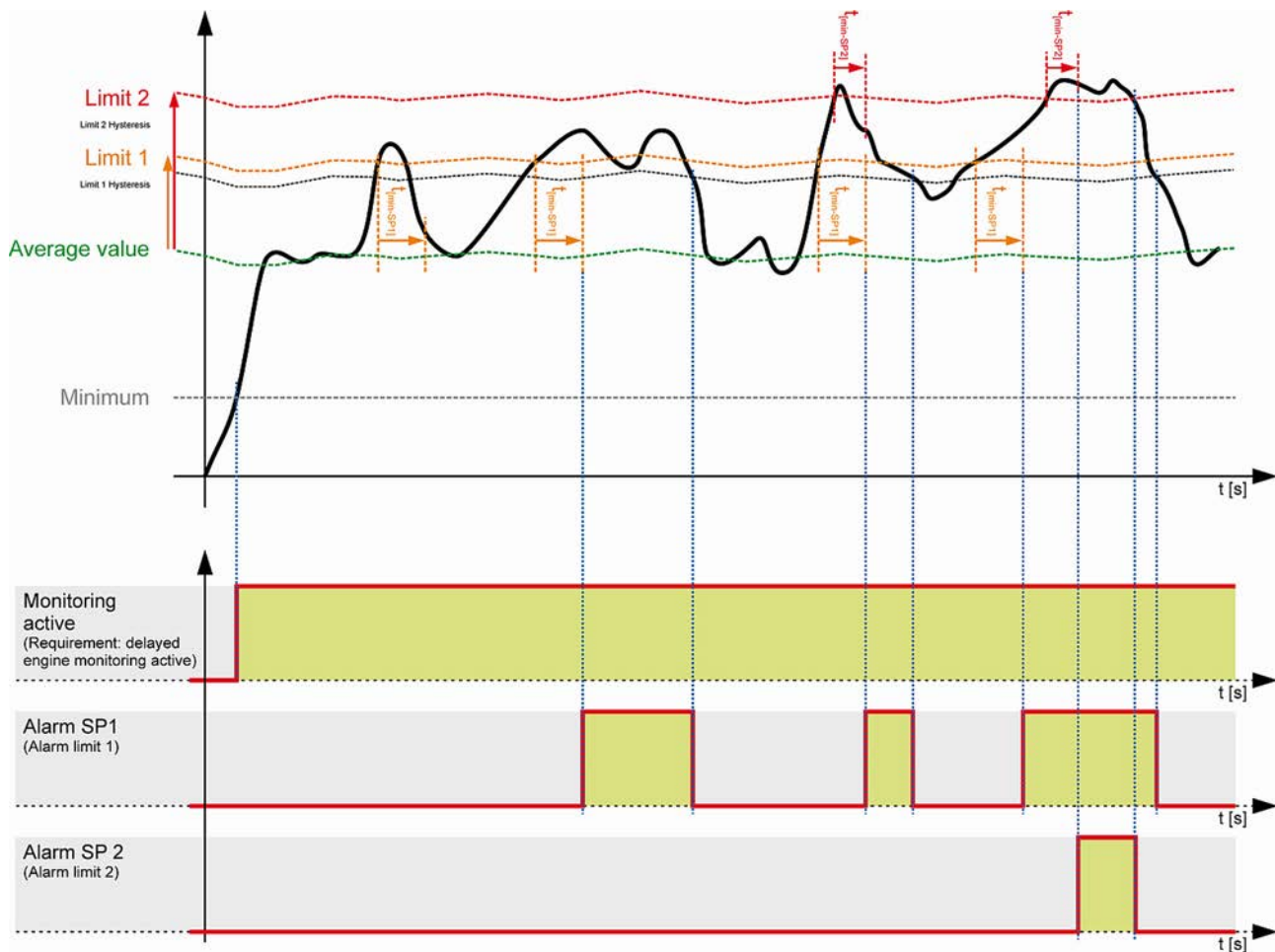

Fig. 291: Two-level unbalanced load monitoring

**One-level asymmetry monitoring**

This triggering characteristic is used for generator voltage asymmetry monitoring.

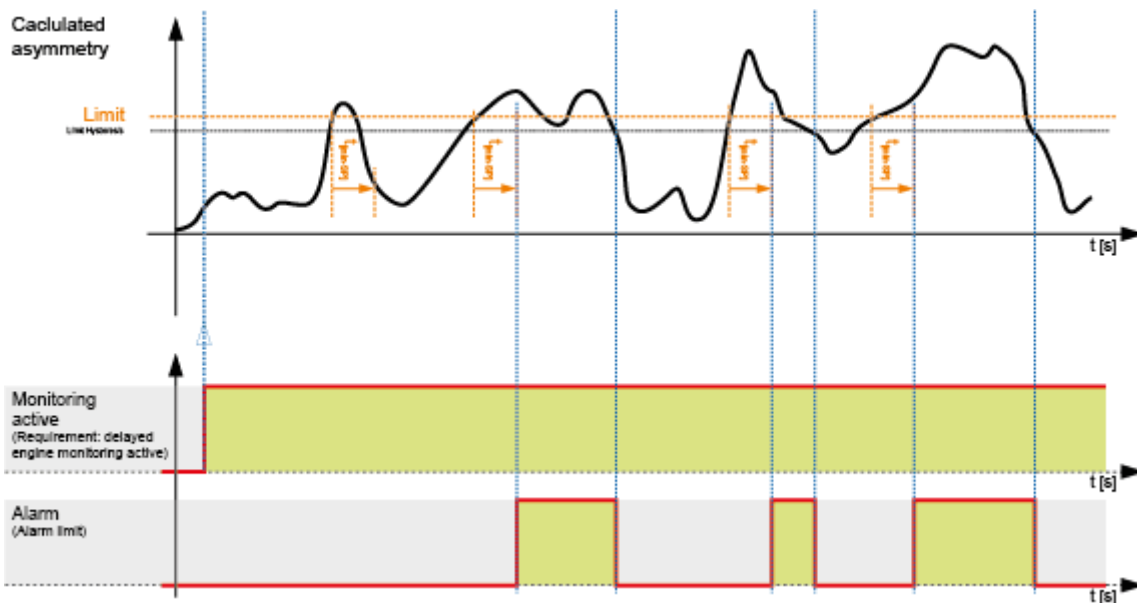

Fig. 292: One-level asymmetry monitoring

### 9.1.2 VDO Inputs Characteristics

Since VDO sensors are available in different types, the index numbers of the characteristic curve tables are listed.

- ➔ Always order VDO sensors with the correct characteristic curve. Manufacturers of VDO sensors usually list these tables in their catalogs.

#### 9.1.2.1 VDO Input "Pressure"

##### 0 to 5 bar/0 to 72 psi - Index "III"

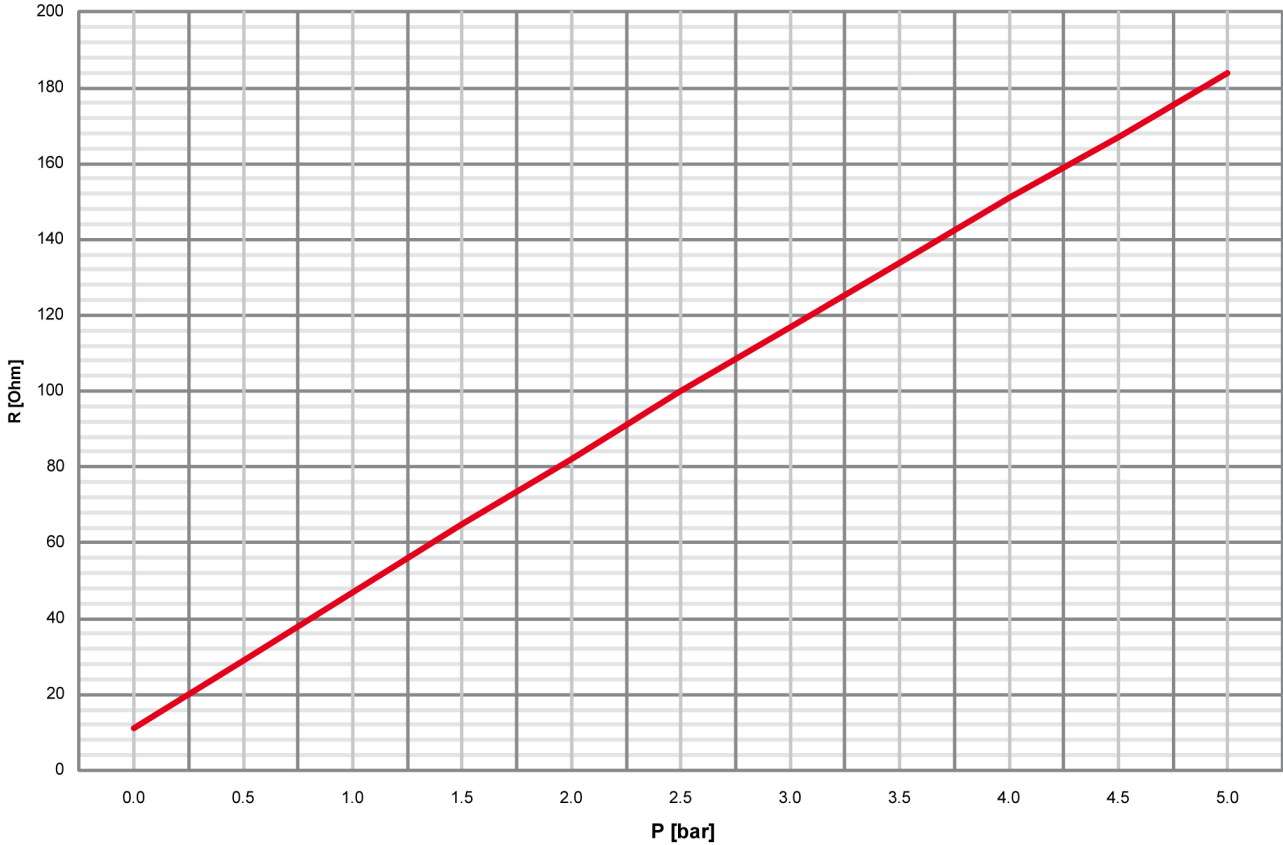

Fig. 293: Characteristics diagram VDO 0 to 5 bar, Index "III"

P [bar]	0	0.5	1	1.5	2	2.5	3	3.5	4	4.5	5
P [psi]	0	7.25	14.50	21.76	29.00	36.26	43.51	50.76	58.02	65.27	72.52
R [Ohm]	11	29	47	65	82	100	117	134	151	167	184

0 to 10 bar/0 to 145 psi - Index "IV"

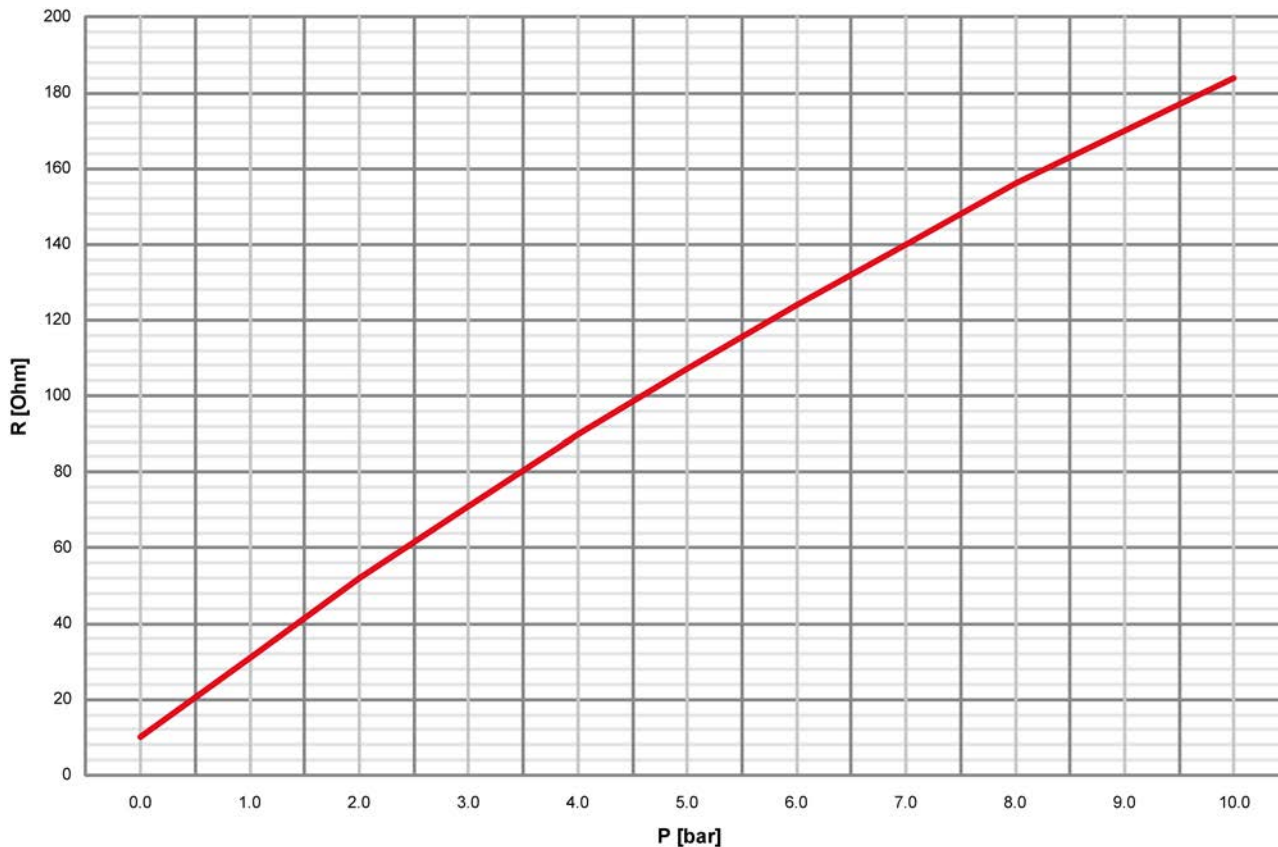

Fig. 294: Characteristics diagram VDO 0 to 10 bar, Index "IV"

P [bar]	0	0.5	1	1.5	2	3	4	5	6	7	8	8.5	9	10
P [psi]	0	7.25	14.50	21.76	29.00	43.51	58.02	72.52	87.02	101.53	116.03	123.28	130.53	145.04
R [Ohm]	10	21	31	42	52	71	90	107	124	140	156	163	170	184

9.1.2.2 VDO Input "Temperature"

40 to 120 °C/104 to 248 °F - Index "92-027-004"

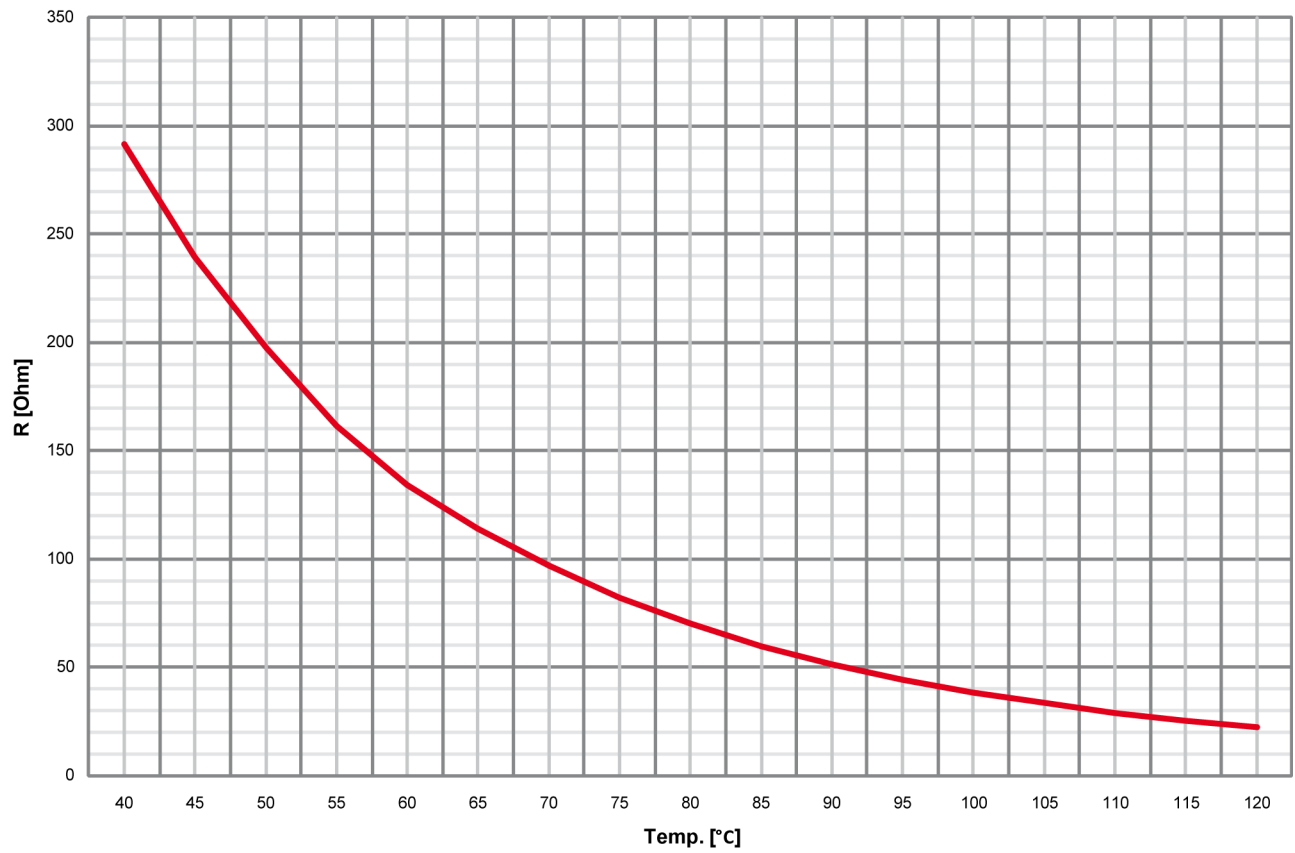

Fig. 295: Characteristics diagram VDO 40 to 120 °C - detail, Index "92-027-004"

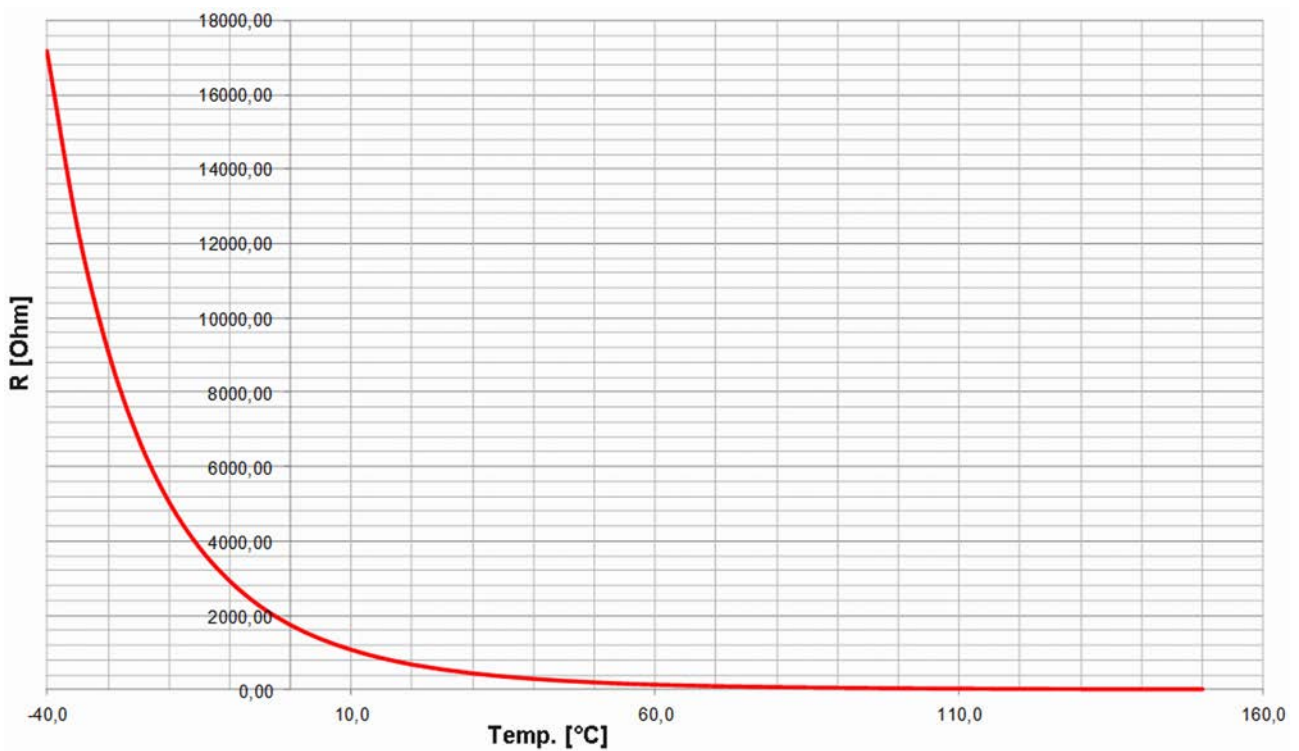

Fig. 296: Characteristics diagram VDO 40 to 120 °C - full range, Index "92-027-004"

Temp. [°C]	-40	-35	-30	-25	-20	-15	-10	-5	0	5	10
Temp. [°F]	-40	-31	-22	-13	-4	5	14	23	32	41	50
R [Ohm]	17162.4	12439.5	9134.5	6764.5	5067.6	3833.9	2929.9	2249.4	1743.1	1364.0	1075.6

Temp. [°C]	15	20	25	30	35	40	45	50	55	60	65
Temp. [°F]	59	68	77	86	95	104	113	122	131	140	149
R [Ohm]	850.1	677.0	543.5	439.3	356.6	291.5	239.6	197.3	161.5	134.0	114.0

Temp. [°C]	70	75	80	85	90	95	100	105	110	115	120
Temp. [°F]	158	167	176	185	194	203	212	221	230	239	248
R [Ohm]	97.1	82.4	70.1	59.7	51.2	44.3	38.5	33.4	29.1	25.5	22.4

Temp. [°C]	125	130	135	140	145	150					
Temp. [°F]	257	266	275	284	293	302					
R [Ohm]	19.75	17.44	15.46	13.75	12.26	10.96					

**50 to 150 °C/122 to 302 °F - Index "92-027-006"**

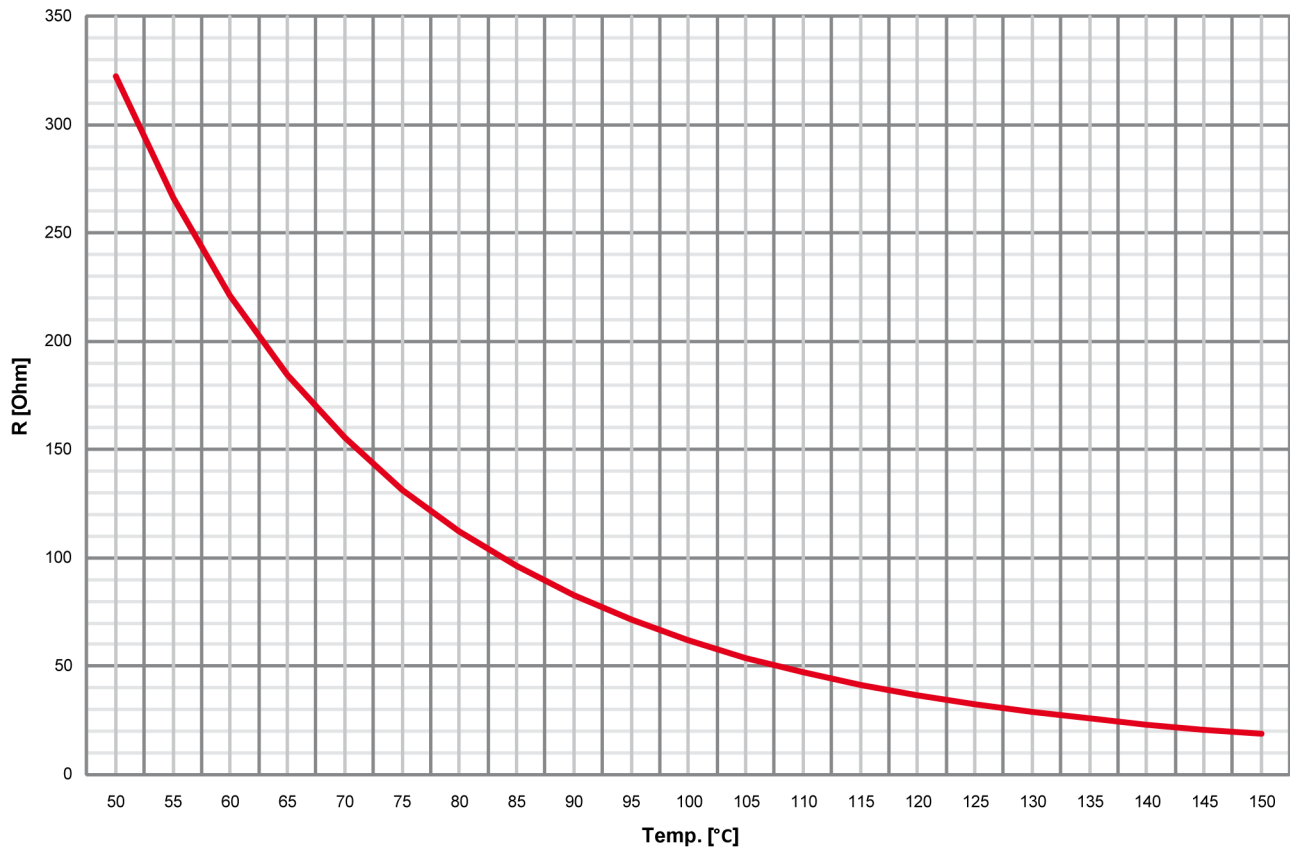

Fig. 297: Characteristics diagram VDO 50 to 150 °C - detail, Index "92-027-006"



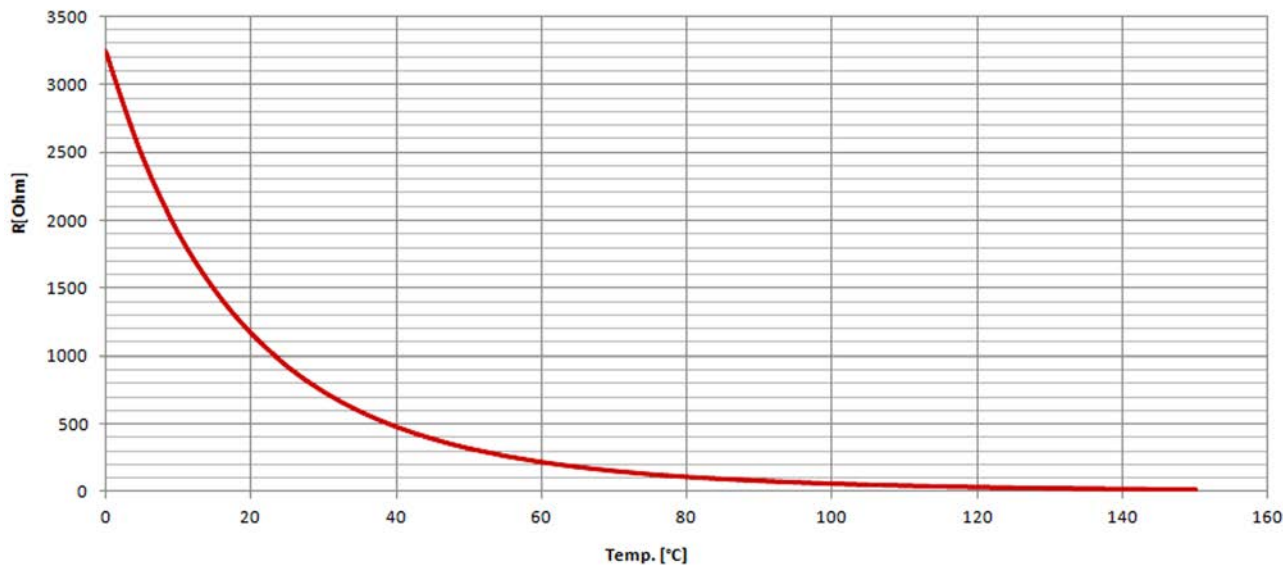

Fig. 298: Characteristics diagram VDO 50 to 120 °C - full range, Index "92-027-006"

Temp. [°C]	0	5	10	15	20	25	30	35	40	45	50
Temp. [°F]	32	41	50	59	68	77	86	95	104	113	122
R [Ohm]	3240.18	2743.6	1905.87	1486.65	1168.64	926.71	739.98	594.9	481.53	392.57	322.17

Temp. [°C]	55	60	65	70	75	80	85	90	95	100	105
Temp. [°F]	131	140	149	158	167	176	185	194	203	212	221
R [Ohm]	266.19	221.17	184.72	155.29	131.38	112.08	96.40	82.96	71.44	61.92	54.01

Temp. [°C]	110	115	120	125	130	135	140	145	150	
Temp. [°F]	230	239	248	257	266	275	284	293	302	
R [Ohm]	47.24	41.42	36.51	32.38	28.81	25.70	23.00	20.66	18.59	

9.1.2.3 Pt100 RTD

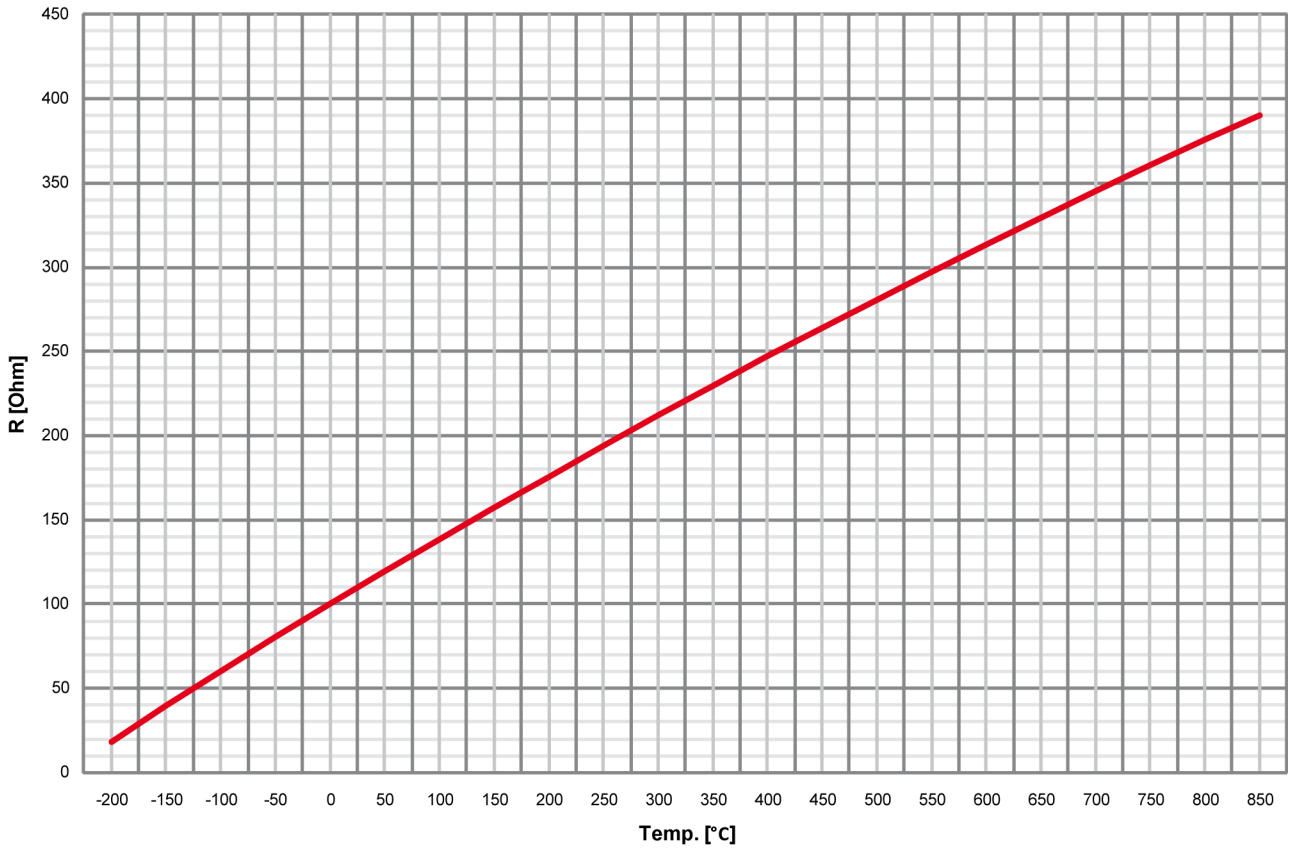

Fig. 299: Characteristics diagram Pt100

Temp. [°C]	-200	-150	-100	-50	0	10	20	30	40	50	60
Temp. [°F]	-328	-238	-148	-58	32	50	68	86	104	122	140
R [Ohm]	18.5	39.7	60.25	80.7	100	103.9	107.8	111.7	115.5	119.4	123.2

Temp. [°C]	70	80	90	100	125	150	175	200	225	250	300
Temp. [°F]	158	176	194	212	257	302	347	392	437	482	572
R [Ohm]	127.1	130.9	134.7	138.5	147.9	157.3	166.6	175.8	188.6	194.1	212.0

Temp. [°C]	350	400	450	500	550	600	650	700	750	800	850
Temp. [°F]	662	752	842	932	1022	1112	1202	1292	1382	1472	1562
R [Ohm]	229.7	247.0	264.1	280.9	297.4	313.6	329.5	345.1	360.5	375.5	390.25

## 9.2 Data Protocols

### General note



The following data telegrams are describing a full set of data for each protocol. Please ignore data your device does not support.

### 9.2.1 CANopen/Modbus

#### 9.2.1.1 Data Protocol 5003 (Basic Visualization)

Modbus		CAN		Parameter ID	Description	Multiplier	Units
Modicon start addr.	Start addr. (*1)	Data byte 0 (Mux)	Data byte				
450001	450000	0	1,2	V	Protocol ID, always 5003		–
450002	450001	0	3,4	10100	Pickup speed	1	rpm
450003	450002	0	5,6	-	Control mode (STOP/AUTO/MANUAL) 1=AUTO 2=STOP 4=MANUAL	Mask: 000Fh	(enum.)
450004	450003	1	1,2	160	Gen. Power factor	0.001	
450005	450004	1	3,4,5,6	170	Av. Gen. Wye-Voltage	0.1	V
450007	450006	2	1,2	144	Gen. frequency	0.01	Hz
450008	450007	2	3,4,5,6	171	Av. Gen. Delta-Voltage	0.1	V
450010	450009	3	1,2	147	Mains frequency	0.01	Hz
450011	450010	3	3,4,5,6	173	Av. Mains Wye-Voltage	0.1	V
450013	450012	4	1,2	208	Mains power factor	0.001	
450014	450013	4	3,4,5,6	174	Av. Mains Delta-Voltage	0.1	V
450016	450015	5	1,2	209	Bus bar 1: Frequency	0.01	Hz
450017	450016	5	3,4,5,6	216	Av. Bus bar 1 Delta-Voltage	0.1	V
450019	450018	6	1,2		internal		
450020	450019	6	3,4		internal		
450021	450020	6	5,6		internal		
450022	450021	7	1,2	10110	Battery voltage	0.1	V
450023	450022	7	3,4,5,6	207	Av. Mains Current	0.001	A
450025	450024	8	1,2	10111	Analog input 1	changeable	
450026	450025	8	3,4,5,6	185	Av. Gen. Current	0.001	A
450028	450027	9	1,2	10112	Analog input 2	changeable	
450029	450028	9	3,4,5,6	161	Meas. ground current	0.001	A
450031	450030	10	1,2	10115	Analog input 3	changeable	

## Appendix

Data Protocols > CANopen/Modbus > Data Protocol ...

Modbus		CAN		Parameter ID	Description	Multiplier	Units
Modicon start addr.	Start addr. (*1)	Data byte 0 (Mux)	Data byte				
450032	450031	10	3,4,5,6	159	Calculated ground current	0.001	A
450034	450033	11	1,2	10117	internal		
450035	450034	11	3,4,5,6	111	Gen. current 1	0.001	A
450037	450036	12	1,2	10151	internal		
450038	450037	12	3,4,5,6	112	Gen. current 2	0.001	A
450040	450039	13	1,2	10152	internal		
450041	450040	13	3,4,5,6	113	Gen. current 3	0.001	A
450043	450042	14	1,2	10153	internal		
450044	450043	14	3,4,5,6	134	Mains current L1	0.001	A
450046	450045	15	1,2	10154	internal		
450047	450046	15	3,4		internal		
450048	450047	15	5,6		internal		
450049	450048	16	1,2		internal		
450050	450049	16	3,4		internal		
450051	450050	16	5,6		internal		
450052	450051	17	1,2		internal		
450053	450052	17	3,4,5,6	135	Total gen. power	1	W
450055	450054	18	1,2		internal		
450056	450055	18	3,4,5,6	140	Total mains power	1	W
450058	450057	19	1,2		internal		
450059	450058	19	3,4,5,6	136	Total gen. reactive power	1	var
450061	450060	20	1,2	10159	AI Auxiliary excitation D+	0.1	V
450062	450061	20	3,4,5,6	150	Total mains reactive power	1	var
450064	450063	21	1,2	2112	Overspeed 1 latched	Mask: 8000h	Bit
				2113	Overspeed 2 latched	Mask: 4000h	Bit
				2162	Underspeed 1 latched	Mask: 2000h	Bit
				2163	Underspeed 2 latched	Mask: 1000h	Bit
				2652	Unintended stop latched	Mask: 0800h	Bit
				2457	Speed det. alarm latched	Mask: 0400h	Bit
				2504	Shutdown malfunction latched	Mask: 0200h	Bit
				2603	GCB fail to close latched	Mask: 0100h	Bit
				2604	GCB fail to open latched	Mask: 0080h	Bit
				2623	MCB fail to close latched	Mask: 0040h	Bit
				2624	MCB fail to open latched	Mask: 0020h	Bit
				10017	CAN-Fault J1939 latched	Mask: 0010h	Bit

Modbus		CAN		Parameter ID	Description	Multiplier	Units
Modicon start addr.	Start addr. (*1)	Data byte 0 (Mux)	Data byte				
				3325	Start fail latched	Mask: 0008h	Bit
				2560	Maintenance days exceeded latched	Mask: 0004h	Bit
				2561	Maintenance hours exceeded latched	Mask: 0002h	Bit
				10087	CANopen error at CAN Interface 1	Mask: 0001h	Bit
450065	450064	21	3,4,5,6	182	Busbar 1: V'voltage L1-L2	0.1	V
450067	450066	22	1,2	3064	GCB syn. timeout latched	Mask: 8000h	Bit
				3074	MCB syn. timeout latched	Mask: 4000h	Bit
				3084	reserved	Mask: 2000h	Bit
				4056	Charge alt. low voltage (D+) latched	Mask: 1000h	Bit
				2944	Ph. rotation mismatch latched	Mask: 0800h	Bit
				10088	CANopen error at CAN Interface 2	Mask: 0020h	Bit
				4073	Parameter Alignment	Mask: 0010h	
				4064	Missing members on CAN	Mask: 0008h	
				1714	EEPROM failure latched	Mask: 0004h	Bit
				15125	Red stop lamp latched	Mask: 0002h	Bit
				15126	Amber warning lamp latched	Mask: 0001h	Bit
450068	450067	22	3,4		internal		
450069	450068	22	5,6		internal		
450070	450069	23	1,2		internal	Mask: 8000h	Bit
					internal	Mask: 4000h	Bit
				5183	Free alarm 4	Mask: 2000h	Bit
				5177	Free alarm 3	Mask: 1000h	Bit
					Free alarm 2	Mask: 0800h	Bit
					Free alarm 1	Mask: 0400h	Bit
					internal	Mask: 0200h	Bit
				5153	Neutral contactor reply mismatch	Mask: 0100h	Bit
				5147	Decoupling GCB↔MCB	Mask: 0080h	Bit
				5141	Meas. difference 4105 VDE-AR-N 4105	Mask: 0040h	Bit
				5135	Parameter alignment VDE-AR-N 4105	Mask: 0020h	Bit
				5129	Missing member VDE-AR-N 4105	Mask: 0010h	Bit
					internal	Mask: 0008h	Bit
					internal	Mask: 0004h	Bit
	internal	Mask: 0002h	Bit				
	internal	Mask: 0001h	Bit				
450071	450070	23	3,4		internal		

## Appendix

Data Protocols > CANopen/Modbus > Data Protocol ...

Modbus		CAN		Parameter ID	Description	Multiplier	Units
Modicon start addr.	Start addr. (*1)	Data byte 0 (Mux)	Data byte				
450072	450071	23	5,6		internal		
450073	450072	24	1,2	1912	Gen. overfreq. 1 latched	Mask: 8000h	Bit
				1913	Gen. overfreq. 2 latched	Mask: 4000h	Bit
				1962	Gen. underfreq. 1 latched	Mask: 2000h	Bit
				1963	Gen. underfreq. 2 latched	Mask: 1000h	Bit
				2012	Gen. overvolt. 1 latched	Mask: 0800h	Bit
				2013	Gen. overvolt. 2 latched	Mask: 0400h	Bit
				2062	Gen. undervolt. 1 latched	Mask: 0200h	Bit
				2063	Gen. undervolt. 2 latched	Mask: 0100h	Bit
				2218	Gen. overcurr. 1 latched	Mask: 0080h	Bit
				2219	Gen. overcurr. 2 latched	Mask: 0040h	Bit
				2220	Gen. overcurr. 3 latched	Mask: 0020h	Bit
				2262	Gen. Rv/Rd pow.1 latched	Mask: 0010h	Bit
				2263	Gen. Rv/Rd pow.2 latched	Mask: 0008h	Bit
				2314	Gen. Overload IOP 1 latched	Mask: 0004h	Bit
				2315	Gen. Overload IOP 2 latched	Mask: 0002h	Bit
					internal	Mask: 0001h	Bit
450074	450073	24	3,4,5,6	108	Gen. voltage L1-L2	0.1	V
450076	450075	25	1,2	2412	Unbal. load 1 latched	Mask: 8000h	Bit
				2413	Unbal. load 2 latched	Mask: 4000h	Bit
				3907	Gen. Asymmetry latched	Mask: 2000h	Bit
				3263	Ground fault 1 latched	Mask: 1000h	Bit
				3264	Ground fault 2 latched	Mask: 0800h	Bit
				3955	Gen. phase rot. misw. Latched	Mask: 0400h	Bit
				2924	Gen act. pwr mismatch Latched	Mask: 0200h	Bit
				3124	Gen. unloading fault Latched	Mask: 0100h	Bit
				4038	Inv. time ov. curr. Latched	Mask: 0080h	Bit
				2664	Operating range failed, latched	Mask: 0040h	Bit
				2362	Gen. Overload MOP 1 latched	Mask: 0020h	Bit
				2363	Gen. Overload MOP 2 latched	Mask: 0010h	Bit
				2337	Gen. overexcited 1 latched	Mask: 0008h	Bit
2338	Gen. overexcited 2 latched	Mask: 0004h	Bit				
2387	Gen. underexcited 1 latched	Mask: 0002h	Bit				
2388	Gen. underexcited 2 latched	Mask: 0001h	Bit				
450077	450076	25	3,4,5,6	114	Gen. voltage L1-N	0.1	V

Modbus		CAN		Parameter ID	Description	Multiplier	Units
Modicon start addr.	Start addr. (*1)	Data byte 0 (Mux)	Data byte				
450079	450078	26	1,2	2862	Mains ov. freq. 1 latched	Mask: 8000h	Bit
				2863	Mains ov. freq. 2 latched	Mask: 4000h	Bit
				2912	Mains un. freq. 1 latched	Mask: 2000h	Bit
				2913	Mains un. freq. 2 latched	Mask: 1000h	Bit
				2962	Mains ov. volt. 1 latched	Mask: 0800h	Bit
				2963	Mains ov. volt. 2 latched	Mask: 0400h	Bit
				3012	Mains in. volt. 1 latched	Mask: 0200h	Bit
				3013	Mains in. volt. 2 latched	Mask: 0100h	Bit
				3057	Mains phaseshift latched	Mask: 0080h	Bit
				3114	Mains decoupling latched	Mask: 0040h	Bit
					internal	Mask: 0020h	Bit
					internal	Mask: 0010h	Bit
					internal	Mask: 0008h	Bit
				3975	Mains phase rot. misw. Latched	Mask: 0004h	Bit
					internal	Mask: 0002h	Bit
	internal	Mask: 0001h	Bit				
450080	450079	26	3,4,5,6	109	Gen. voltage L2-L3	0.1	V
450082	450081	27	1,2	3217	Mains import power 1 latched	Mask: 8000h	Bit
				3218	Mains import power 2 latched	Mask: 4000h	Bit
				3241	Mains export power 1 latched	Mask: 2000h	Bit
				3242	Mains export power 2 latched	Mask: 1000h	Bit
				2985	Mains overexcited 1 latched	Mask: 0800h	Bit
				2986	Mains overexcited 2 latched	Mask: 0400h	Bit
				3035	Mains underexcited 1 latched	Mask: 0200h	Bit
				3036	Mains underexcited 2 latched	Mask: 0100h	Bit
				3106	Mains df/dt	Mask: 0080h	Bit
				2934	Mns act. pwr mismatch latched	Mask: 0040h	Bit
				4958	Mains. Time dep. Voltage	Mask: 0020h	Bit
					internal	Mask: 0010h	Bit
				8834	Mains Voltage Increase	Mask: 0008h	Bit
					internal	Mask: 0004h	Bit
				3288	Mains QV Monitoring step 1	Mask: 0002h	Bit
3289	Mains QV Monitoring step 2	Mask: 0001h	Bit				
450083	450082	27	3,4,5,6	115	Gen. voltage L2-N	0.1	V
450085	450084	28	1,2	10600	State Digital Input 1 latched	Mask: 8000h	Bit

## Appendix

Data Protocols > CANopen/Modbus > Data Protocol ...

Modbus		CAN		Parameter ID	Description	Multiplier	Units
Modicon start addr.	Start addr. (*1)	Data byte 0 (Mux)	Data byte				
				10601	State Digital Input 2 latched	Mask: 4000h	Bit
				10602	State Digital Input 3 latched	Mask: 2000h	Bit
				10603	State Digital Input 4 latched	Mask: 1000h	Bit
				10604	State Digital Input 5 latched	Mask: 0800h	Bit
				10605	State Digital Input 6 latched	Mask: 0400h	Bit
				10607	State Digital Input 7 latched	Mask: 0200h	Bit
				10608	State Digital Input 8 (reply GCB)	Mask: 0100h	Bit
				10609	State Digital Input 9 latched	Mask: 0080h	Bit
				10610	State Digital Input 10 latched	Mask: 0040h	Bit
				10611	State Digital Input 11 latched	Mask: 0020h	Bit
				10612	State Digital Input 12 latched	Mask: 0010h	Bit
450086	450085	28	3,4,5,6	110	Gen. voltage L3-L1	0.1	V
450088	450087	29	1,2	10613	State Digital Input 13 latched, 	Mask: 8000h	Bit
				10614	State Digital Input 14, 	Mask: 4000h	Bit
				10615	State Digital Input 15, 	Mask: 2000h	Bit
				10616	State Digital Input 16, 	Mask: 1000h	Bit
				10617	State Digital Input 17, 	Mask: 0800h	Bit
				10618	State Digital Input 18, 	Mask: 0400h	Bit
				10619	State Digital Input 19, 	Mask: 0200h	Bit
				10620	State Digital Input 20, 	Mask: 0100h	Bit
				10621	State Digital Input 21, 	Mask: 0080h	Bit
				10622	State Digital Input 22, 	Mask: 0040h	Bit
				10623	State Digital Input 23, 	Mask: 0020h	Bit
					internal	Mask: 0010h	Bit
					internal	Mask: 0008h	Bit
					internal	Mask: 0004h	Bit
					internal	Mask: 0002h	Bit
					internal	Mask: 0001h	Bit
450089	450088	29	3,4,5,6	116	Gen. voltage L3-N	0.1	V
450091	450090	30	1,2	16376	State ext. Digital Input 16 latched	Mask: 8000h	Bit
				16375	State ext. Digital Input 15 latched	Mask: 4000h	Bit
				16374	State ext. Digital Input 14 latched	Mask: 2000h	Bit
				16373	State ext. Digital Input 13 latched	Mask: 1000h	Bit



Modbus		CAN		Parameter ID	Description	Multiplier	Units
Modicon start addr.	Start addr. (*1)	Data byte 0 (Mux)	Data byte				
				16372	State ext. Digital Input 12 latched	Mask: 0800h	Bit
				16371	State ext. Digital Input 11 latched	Mask: 0400h	Bit
				16370	State ext. Digital Input 10 latched	Mask: 0200h	Bit
				16369	State ext. Digital Input 9 latched	Mask: 0100h	Bit
				16368	State ext. Digital Input 8 latched	Mask: 0080h	Bit
				16367	State ext. Digital Input 7 latched	Mask: 0040h	Bit
				16366	State ext. Digital Input 6 latched	Mask: 0020h	Bit
				16365	State ext. Digital Input 5 latched	Mask: 0010h	Bit
				16364	State ext. Digital Input 4 latched	Mask: 0008h	Bit
				16362	State ext. Digital Input 3 latched	Mask: 0004h	Bit
				16361	State ext. Digital Input 2 latched	Mask: 0002h	Bit
				16360	State ext. Digital Input 1 latched	Mask: 0001h	Bit
450092	450091	30	3,4,5,6	118	Mains voltage L1-L2	0.1	V
450094	450093	31	1,2	10033	Alarm flexible limit 16 latched	Mask: 8000h	Bit
				10032	Alarm flexible limit 15 latched	Mask: 4000h	Bit
				10031	Alarm flexible limit 14 latched	Mask: 2000h	Bit
				10030	Alarm flexible limit 13 latched	Mask: 1000h	Bit
				10029	Alarm flexible limit 12 latched	Mask: 0800h	Bit
				10028	Alarm flexible limit 11 latched	Mask: 0400h	Bit
				10027	Alarm flexible limit 10 latched	Mask: 0200h	Bit
				10026	Alarm flexible limit 9 latched	Mask: 0100h	Bit
				10025	Alarm flexible limit 8 latched	Mask: 0080h	Bit
				10024	Alarm flexible limit 7 latched	Mask: 0040h	Bit
				10023	Alarm flexible limit 6 latched	Mask: 0020h	Bit
				10022	Alarm flexible limit 5 latched	Mask: 0010h	Bit
				10021	Alarm flexible limit 4 latched	Mask: 0008h	Bit
				10020	Alarm flexible limit 3 latched	Mask: 0004h	Bit
				10019	Alarm flexible limit 2 latched	Mask: 0002h	Bit
				10018	Alarm flexible limit 1 latched	Mask: 0001h	Bit
450095	450094	31	3,4,5,6	121	Mains voltage L1-N	0.1	V
450097	450096	32	1,2	10049	Alarm flexible limit 32 latched	Mask: 8000h	Bit
				10048	Alarm flexible limit 31 latched	Mask: 4000h	Bit
				10047	Alarm flexible limit 30 latched	Mask: 2000h	Bit
				10046	Alarm flexible limit 29 latched	Mask: 1000h	Bit
				10045	Alarm flexible limit 28 latched	Mask: 0800h	Bit

## Appendix







Data Protocols > CANopen/Modbus > Data Protocol ...

Modbus		CAN		Parameter ID	Description	Multiplier	Units
Modicon start addr.	Start addr. (*1)	Data byte 0 (Mux)	Data byte				
				10044	Alarm flexible limit 27 latched	Mask: 0400h	Bit
				10043	Alarm flexible limit 26 latched	Mask: 0200h	Bit
				10042	Alarm flexible limit 25 latched	Mask: 0100h	Bit
				10041	Alarm flexible limit 24 latched	Mask: 0080h	Bit
				10040	Alarm flexible limit 23 latched	Mask: 0040h	Bit
				10039	Alarm flexible limit 22 latched	Mask: 0020h	Bit
				10038	Alarm flexible limit 21 latched	Mask: 0010h	Bit
				10037	Alarm flexible limit 20 latched	Mask: 0008h	Bit
				10036	Alarm flexible limit 19 latched	Mask: 0004h	Bit
				10035	Alarm flexible limit 18 latched	Mask: 0002h	Bit
				10034	Alarm flexible limit 17 latched	Mask: 0001h	Bit
450098	450097	32	3,4,5,6	119	Mains voltage L2-L3	0.1	V
450100	450099	33	1,2		internal	Mask: 8000h	Bit
					internal	Mask: 4000h	Bit
					internal	Mask: 2000h	Bit
					internal	Mask: 1000h	Bit
					internal	Mask: 0800h	Bit
					internal	Mask: 0400h	Bit
					internal	Mask: 0200h	Bit
					internal	Mask: 0100h	Bit
				10057	Alarm flexible limit 40 latched	Mask: 0080h	Bit
				10056	Alarm flexible limit 39 latched	Mask: 0040h	Bit
				10055	Alarm flexible limit 38 latched	Mask: 0020h	Bit
				10054	Alarm flexible limit 37 latched	Mask: 0010h	Bit
				10053	Alarm flexible limit 36 latched	Mask: 0008h	Bit
				10052	Alarm flexible limit 35 latched	Mask: 0004h	Bit
10051	Alarm flexible limit 34 latched	Mask: 0002h	Bit				
10050	Alarm flexible limit 33 latched	Mask: 0001h	Bit				
450101	450100	33	3,4,5,6	122	Mains voltage L2-N	0.1	V
450103	450102	34	1,2	1008	Batt. overvolt.2 latched	Mask: 0008h	Bit
				1007	Batt. undervolt.2 latched	Mask: 0004h	Bit
				1006	Batt. overvolt.1 latched	Mask: 0002h	Bit
				1005	Batt. undervolt.1 latched	Mask: 0001h	Bit
450104	450103	34	3,4,5,6	120	Mains voltage L3-L1	0.1	V
450106	450105	35	1,2	10131	internal	Mask: 0040h	Bit

Modbus		CAN		Parameter ID	Description	Multiplier	Units
Modicon start addr.	Start addr. (*1)	Data byte 0 (Mux)	Data byte				
					Alarm class F latched	Mask: 0020h	Bit
					Alarm class E latched	Mask: 0010h	Bit
					Alarm class D latched	Mask: 0008h	Bit
					Alarm class C latched	Mask: 0004h	Bit
					Alarm class B latched	Mask: 0002h	Bit
					Alarm class A latched	Mask: 0001h	Bit
450107	450106	35	3,4,5,6	123	Mains voltage L3-N	0.1	V
450109	450108	36	1,2	10014	Analog inp. 1, wire break	Mask: 0002h	Bit
				10015	Analog inp. 2, wire break	Mask: 0004h	Bit
				10060	Analog inp. 3, wire break	Mask: 0008h	Bit
				10061	Analog inp. 4, wire break or shortcut latched, 	Mask: 0010h	Bit
				10062	Analog inp. 5, wire break or shortcut latched, 	Mask: 0020h	Bit
				10063	Analog inp. 6, wire break or shortcut latched, 	Mask: 0040h	Bit
				10064	Analog inp. 7, wire break or shortcut latched, 	Mask: 0080h	Bit
				10065	Analog inp. 8, wire break or shortcut latched, 	Mask: 0100h	Bit
				10066	Analog inp. 9, wire break or shortcut latched, 	Mask: 0200h	Bit
				10067	Analog inp. 10, wire break or shortcut latched, 	Mask: 0400h	Bit
				10068	internal	Mask: 0800h	Bit
				10069	internal	Mask: 1000h	Bit
					internal	Mask: 2000h	Bit
	internal	Mask: 4000h	Bit				
	internal	Mask: 8000h	Bit				
450110	450109	36	3,4	15310	Turbocharger 1 Compressor Outlet Temperature	0.1	°C
450111	450110	36	5,6	10221	Ext. analog inp. 1, wire break	Mask: 0001h	Bit
				10222	Ext. analog inp. 2, wire break	Mask: 0002h	Bit
				10223	Ext. analog inp. 3, wire break	Mask: 0004h	Bit
				10224	Ext. analog inp. 4, wire break	Mask: 0008h	Bit
				10225	Ext. analog inp. 5, wire break	Mask: 0010h	Bit
				10226	Ext. analog inp. 6, wire break	Mask: 0020h	Bit
				10227	Ext. analog inp. 7, wire break	Mask: 0040h	Bit

## Appendix

Data Protocols > CANopen/Modbus > Data Protocol ...

Modbus		CAN		Parameter ID	Description	Multiplier	Units
Modicon start addr.	Start addr. (*1)	Data byte 0 (Mux)	Data byte				
				10228	Ext. analog inp. 8, wire break	Mask: 0080h	Bit
				10229	Ext. analog inp. 9, wire break	Mask: 0100h	Bit
				10230	Ext. analog inp. 10, wire break	Mask: 0200h	Bit
				10231	Ext. analog inp. 11, wire break	Mask: 0400h	Bit
				10232	Ext. analog inp. 12, wire break	Mask: 0800h	Bit
				10233	Ext. analog inp. 13, wire break	Mask: 1000h	Bit
				10234	Ext. analog inp. 14, wire break	Mask: 2000h	Bit
				10235	Ext. analog inp. 15, wire break	Mask: 4000h	Bit
				10236	Ext. analog inp. 16, wire break	Mask: 8000h	Bit
450112	450111	37	1,2	10107	Digital outputs 1 to 12		
					Relay-Output 1 (inverted)	Mask: 8000h	Bit
					Relay-Output 2	Mask: 4000h	Bit
					Relay-Output 3	Mask: 2000h	Bit
					Relay-Output 4	Mask: 1000h	Bit
					Relay-Output 5	Mask: 0800h	Bit
					Relay-Output 6	Mask: 0400h	Bit
					Relay-Output 7	Mask: 0200h	Bit
					Relay-Output 8	Mask: 0100h	Bit
					Relay-Output 9	Mask: 0080h	Bit
					Relay-Output 10	Mask: 0040h	Bit
					Relay-Output 11	Mask: 0020h	Bit
					Relay-Output 12	Mask: 0010h	Bit
					internal	Mask: 0008h	Bit
					internal	Mask: 0004h	Bit
					internal	Mask: 0002h	Bit
					internal	Mask: 0001h	Bit
450113	450112	37	3,4	10109	Digital outputs 13 to 22		
					Relay-Output 13, 	Mask: 8000h	Bit
					Relay-Output 14, 	Mask: 4000h	Bit
					Relay-Output 15, 	Mask: 2000h	Bit
					Relay-Output 16, 	Mask: 1000h	Bit
					Relay-Output 17, 	Mask: 0800h	Bit
					Relay-Output 18, 	Mask: 0400h	Bit
					Relay-Output 19, 	Mask: 0200h	Bit

Modbus		CAN		Parameter ID	Description	Multiplier	Units
Modicon start addr.	Start addr. (*1)	Data byte 0 (Mux)	Data byte				
					Relay-Output 20, 	Mask: 0100h	Bit
					Relay-Output 21, 	Mask: 0080h	Bit
					Relay-Output 22, 	Mask: 0040h	Bit
					internal	Mask: 0020h	Bit
					internal	Mask: 0010h	Bit
					internal	Mask: 0008h	Bit
					internal	Mask: 0004h	Bit
					internal	Mask: 0002h	Bit
					internal	Mask: 0001h	Bit
450114	450113	37	5,6	8005	External Relay-Output 16	Mask DO 16 8000h	Bit
					External Relay-Output 15	Mask DO 15 4000h	Bit
					External Relay-Output 14	Mask DO 14 2000h	Bit
					External Relay-Output 13	Mask DO 13 1000h	Bit
					External Relay-Output 12	Mask DO 12 0800h	Bit
					External Relay-Output 11	Mask DO 11 0400h	Bit
					External Relay-Output 10	Mask DO 10 0200h	Bit
					External Relay-Output 9	Mask DO 09 0100h	Bit
					External Relay-Output 8	Mask DO 08 0080h	Bit
					External Relay-Output 7	Mask DO 07 0040h	Bit
					External Relay-Output 6	Mask DO 06 0020h	Bit
					External Relay-Output 5	Mask DO 05 0010h	Bit
					External Relay-Output 4	Mask DO 04 0008h	Bit

## Appendix

Data Protocols > CANopen/Modbus > Data Protocol ...

Modbus		CAN		Parameter ID	Description	Multiplier	Units
Modicon start addr.	Start addr. (*1)	Data byte 0 (Mux)	Data byte				
					External Relay-Output 3	Mask DO 03 0004h	Bit
					External Relay-Output 2	Mask DO 02 0002h	Bit
					External Relay-Output 1	Mask DO 01 0001h	Bit
450115	450114	38	1,2	10310	Analog output 1	0.01	%
450116	450115	38	3,4	10311	Analog output 2	0.01	%
450117	450116	38	5,6		internal		
450118	450117	39	1,2	10318	internal		
450119	450118	39	3,4	10319	internal		
450120	450119	39	5,6	10320	internal		

Modbus		CAN		Parameter ID	Description	Multiplier	Units
Modicon start addr.	Start addr. (*1)	Data byte 0 (Mux)	Data byte				
450121	450120	40	1,2	10202	Operation modes (in numerical order) 13200 = Auxiliary services postrun 13201 = Auxiliary services prerun 13202 = Critical mode 13203 = Motor Stop 13204 = Cool down 13205 = Mains settling 13206 = Engine Start 13207 = Start – Pause 13208 = Preglow 13209 = GCB dead bus close 13210 = MCB dead bus close 13211 = Emergency run 13212 = Turning 13213 = Ignition 13214 = Crank protect 13215 = Emergency/Critical 13216 = Idle run active 13250 = Gen. stable time 13251 = In operation 13252 = Power limited prerun 13253 = AUTO mode ready 13254 = Ramp to rated 13255 = GCB open 13256 = Unloading generator 13257 = MCB open 13258 = Loading generator 13259 = Synchronization GCB 13260 = Synchronization MCB 13261 = GCB -> MCB Delay 13262 = MCB -> GCB Delay 13263 = Start w/o Load 13264 = Unloading mains 13265 = Synchronization permissive 13266 = Synchronization check 13267 = Synchronization off 13281 = Derating active 13284 = Inhibit cranking		(enum.)

## Appendix

Data Protocols > CANopen/Modbus > Data Protocol ...

Modbus		CAN		Parameter ID	Description	Multiplier	Units
Modicon start addr.	Start addr. (*1)	Data byte 0 (Mux)	Data byte				
					13311 = Inhibit dead bus closure		
450122	450121	40	3,4,5,6	2520	Gen. real energy	0.01	MWh
450124	450123	41	1,2	2540	Engine, number of start requests	1	
450125	450124	41	3,4,5,6	2522	Positive reactive generator energy	0.01	Mvar h
450127	450126	42	1,2	2558	Hours until next maintenance	1	h
450128	450127	42	3,4,5,6	2568	Gen. hours of operation	0.01	h
450130	450129	43	1,2	5541	Frequency setpoint	0.01	Hz
450131	450130	43	3,4,5,6	5542	Active Power setpoint	0.1	kW
450133	450132	44	1,2,3,4	5640	Voltage setpoint	1	V
450135	450134	44	5,6	5641	Power Factor setpoint	0.001	
450136	450135	45	1,2	4153	Idle mode monitoring (suppresses under- volt, underfreq,...)	Mask: 8000h	Bit
					Idle mode active	Mask: 4000h	Bit
					Start without closing GCB	Mask: 2000h	Bit
					internal	Mask: 1000h	Bit
					A manual START has been requested	Mask: 0800h	Bit
					A manual STOP has been requested	Mask: 0400h	Bit
					Cooldown is active	Mask: 0200h	Bit
					Auxiliary services generally active	Mask: 0100h	Bit
					Engine monitoring delay timer has expired	Mask: 0080h	Bit
					Breaker delay timer has expired	Mask: 0040h	Bit
					Engine start is requested	Mask: 0020h	Bit
					Critical mode is active in auto mode	Mask: 0010h	Bit
					Engine is released (speed governor is enabled)	Mask: 0008h	Bit
					Auxiliary services prerun is active	Mask: 0004h	Bit
					Auxiliary services postrun is active	Mask: 0002h	Bit
Lamp test is active	Mask: 0001h	Bit					
450137	450136	45	3,4	4154	Crank (Starter) is active	Mask: 8000h	Bit
					Operating Magnet / Gas relay is active	Mask: 4000h	Bit
					Preglow / Ignition is active	Mask: 2000h	Bit
					Mains settling timer is running	Mask: 1000h	Bit
					Emergency mode is currently active	Mask: 0800h	Bit
					internal	Mask: 0400h	Bit
					 only: Free PID Controller 3: Lower Command	Mask: 0200h	Bit



Modbus		CAN		Parameter ID	Description	Multiplier	Units
Modicon start addr.	Start addr. (*1)	Data byte 0 (Mux)	Data byte				
					only: Free PID Controller 3: Raise Command	Mask: 0100h	Bit
					only: Free PID Controller 2: Lower Command	Mask: 0080h	Bit
					only: Free PID Controller 2: Raise Command	Mask: 0040h	Bit
					Stopping Magnet is active	Mask: 0020h	Bit
					Excitation AVR (run-up synchronization)	Mask: 0010h	Bit
					The genset runs mains parallel	Mask: 0008h	Bit
					only: Free PID Controller 1: Lower Command	Mask: 0004h	Bit
					only: Free PID Controller 1: Raise Command	Mask: 0002h	Bit
					Increment Start Counter	Mask: 0001h	Bit
450138	450137	45	5,6	4155	3-Position Controller Freq./Power raise	Mask: 8000h	Bit
					3-Position Controller Freq./Power lower	Mask: 4000h	Bit
					3-Position Controller Volt./ReactPow raise	Mask: 2000h	Bit
					3-Position Controller Volt./ReactPow lower	Mask: 1000h	Bit
					GCB is closed	Mask: 0800h	Bit
					MCB is closed	Mask: 0400h	Bit
					Derating active	Mask: 0200h	Bit
					Synchronization GCB is active	Mask: 0100h	Bit
					Opening GCB is active	Mask: 0080h	Bit
					Closing GCB is active	Mask: 0040h	Bit
					Synchronization MCB is active	Mask: 0020h	Bit
					Opening MCB is active	Mask: 0010h	Bit
					Closing MCB is active	Mask: 0008h	Bit
					Unloading generator is active	Mask: 0004h	Bit
					Unloading mains is active	Mask: 0002h	Bit
					Power limited prerun	Mask: 0001h	Bit
450139	450138	46	1,2	4156	reserved	Mask: 8000h	Bit
					reserved	Mask: 4000h	Bit
					reserved	Mask: 2000h	Bit
					reserved	Mask: 1000h	Bit
					reserved	Mask: 0800h	Bit

## Appendix



Data Protocols > CANopen/Modbus > Data Protocol ...

Modbus		CAN		Parameter ID	Description	Multiplier	Units
Modicon start addr.	Start addr. (*1)	Data byte 0 (Mux)	Data byte				
					Dead busbar closure request for GCB or MCB	Mask: 0400h	Bit
					Active power load share is active	Mask: 0200h	Bit
					Reactive power load share is active	Mask: 0100h	Bit
					Generator with a closed GCB is re-quested	Mask: 0080h	Bit
					LDSS: The Engine shall start	Mask: 0040h	Bit
					LDSS: The Engine shall stop	Mask: 0020h	Bit
					LDSS: The Engine shall stop, if possible	Mask: 0010h	Bit
					LDSS: Minimum Running Time is active	Mask: 0008h	Bit
					LDSS: The LDSS function is active	Mask: 0004h	Bit
					The Critical Mode Postrun is active	Mask: 0002h	Bit
					AUTOMATIC Run: Switch to Operating Mode STOP	Mask: 0001h	Bit
450140	450139	46	3,4		internal		
450141	450140	46	5,6	16352	 only: State external DI 32 latched	Mask: 8000h	Bit
				16342	 only: State external DI 31 latched	Mask: 4000h	Bit
				16332	 only: State external DI 30 latched	Mask: 2000h	Bit
				16322	 only: State external DI 29 latched	Mask: 1000h	Bit
				16312	 only: State external DI 28 latched	Mask: 0800h	Bit
				16302	 only: State external DI 27 latched	Mask: 0400h	Bit
				16292	 only: State external DI 26 latched	Mask: 0200h	Bit
				16282	 only: State external DI 25 latched	Mask: 0100h	Bit
				16272	 only: State external DI 24 latched	Mask: 0080h	Bit
				16262	 only: State external DI 23 latched	Mask: 0040h	Bit
				16252	 only: State external DI 22 latched	Mask: 0020h	Bit
				16242	 only: State external DI 21 latched	Mask: 0010h	Bit
				16232	 only: State external DI 20 latched	Mask: 0008h	Bit
				16222	 only: State external DI 19 latched	Mask: 0004h	Bit
				16212	 only: State external DI 18 latched	Mask: 0002h	Bit
				16202	 only: State external DI 17 latched	Mask: 0001h	Bit
450142	450141	47	1,2	8009	 only: External Discrete Output DO 32	Mask: 8000h	Bit
					 only: External Discrete Output DO 31	Mask: 4000h	Bit
					 only: External Discrete Output DO 30	Mask: 2000h	Bit

Modbus		CAN		Parameter ID	Description	Multiplier	Units
Modicon start addr.	Start addr. (*1)	Data byte 0 (Mux)	Data byte				
					only: External Discrete Output DO 29	Mask: 1000h	Bit
					only: External Discrete Output DO 28	Mask: 0800h	Bit
					only: External Discrete Output DO 27	Mask: 0400h	Bit
					only: External Discrete Output DO 26	Mask: 0200h	Bit
					only: External Discrete Output DO 25	Mask: 0100h	Bit
					only: External Discrete Output DO 24	Mask: 0080h	Bit
					only: External Discrete Output DO 23	Mask: 0040h	Bit
					only: External Discrete Output DO 22	Mask: 0020h	Bit
					only: External Discrete Output DO 21	Mask: 0010h	Bit
					only: External Discrete Output DO 20	Mask: 0008h	Bit
					only: External Discrete Output DO 19	Mask: 0004h	Bit
					only: External Discrete Output DO 18	Mask: 0002h	Bit
					only: External Discrete Output DO 17	Mask: 0001h	Bit
450143	450142	47	3,4	10170	only: External Analog input 1	changeable	
450144	450143	47	5,6	10171	only: External Analog input 2	changeable	
450145	450144	48	1,2	10172	only: External Analog input 3	changeable	
450146	450145	48	3,4	10173	only: External Analog input 4	changeable	
450147	450146	48	5,6	10174	only: External Analog input 5	changeable	
450148	450147	49	1,2	10175	only: External Analog input 6	changeable	
450149	450148	49	3,4	10176	only: External Analog input 7	changeable	
450150	450149	49	5,6	10177	only: External Analog input 8	changeable	
450151	450150	50	1,2	10178	only: External Analog input 9	changeable	
450152	450151	50	3,4	10179	only: External Analog input 01	changeable	
450153	450152	50	5,6	10180	only: External Analog input 11	changeable	
450154	450153	51	1,2	10181	only: External Analog input 12	changeable	
450155	450154	51	3,4	10182	only: External Analog input 13	changeable	
450156	450155	51	5,6	10183	only: External Analog input 14	changeable	
450157	450156	52	1,2	10184	only: External Analog input 15	changeable	
450158	450157	52	3,4	10185	only: External Analog input 16	changeable	
450159	450158	52	5,6	10245	only: External Analog Output 1	0.01	%
450160	450159	53	1,2	10255	only: External Analog Output 2	0.01	%

## Appendix

Data Protocols > CANopen/Modbus > Data Protocol ...

Modbus		CAN		Parameter ID	Description	Multiplier	Units
Modicon start addr.	Start addr. (*1)	Data byte 0 (Mux)	Data byte				
450161	450160	53	3,4	10265	 only: External Analog Output 3	0.01	%
450162	450161	53	5,6	10275	 only: External Analog Output 4	0.01	%
450163	450162	54	1,2		internal		
450164	450163	54	3,4		internal		
450165	450164	54	5,6		internal		
450166	450165	55	1,2	3089	internal	Mask: 8000h	Bit
				3090	internal	Mask: 4000h	Bit
				14575	Temperature deviation level 1	Mask 0800h	Bit
				14576	Temperature deviation level 2	Mask 0400h	Bit
				14584	Temperature deviation wire break	Mask 0200h	Bit
450167	450166	55	3,4,5,6	219	Nominal active power in system (in own segment)		kW
450169	450168	56	1,2	4157	Command to CB-control 1 (OR)	Mask 8000h	Bit
					Command to CB-control 2 (OR)	Mask 4000h	Bit
					Command to CB-control 3 (OR)	Mask 2000h	Bit
					Command to CB-control 4 (OR)	Mask 1000h	Bit
					Command to CB-control 5 (OR)	Mask 0800h	Bit
					Command to CB-control 6 (OR)	Mask 0400h	Bit
					Gen excitation limit active	Mask 0200h	Bit
					Neutral interlocking closed NC	Mask 0100h	Bit
					internal	Mask 0080h	Bit
					internal	Mask 0040h	Bit
					internal	Mask 0020h	Bit
					internal	Mask 0010h	Bit
					internal	Mask 0008h	Bit
					internal	Mask 0004h	Bit
internal	Mask 0002h	Bit					
internal	Mask 0001h	Bit					
450170	450169	56	3,4,5,6	218	Active real power in system (in own segment)		kW
450172	450171	57	1,2	10277	Option K36 only: Diff. outlet-inlet temp. (ANIN10-ANIN9)	1	°C
450173	450172	57	3,4,5,6	217	Active power reserve in system (in own segment)		kW
450175	450174	58	1,2	15109	J1939 MTU ADEC ECU Failure Codes	1	
450176	450175	58	3,4	239	System act. nom. pwr.		
450177	450176	58	5,6	240	Syst. total real pwr.		

Modbus		CAN		Parameter ID	Description	Multiplier	Units
Modicon start addr.	Start addr. (*1)	Data byte 0 (Mux)	Data byte				
450178	450177	59	1,2	15304	Engine Stop Information (e.g. DEUTZ-specific J1939-Message; refer to the Deutz documentation for information)	1	(enum.)
450179	450178	59	3,4	241	Syst. res. real power		
450180	450179	59	5,6	15311	Engine Derate Request	0.1	%
450181	450180	60	1,2	15305	J1939 DLN2-Message Scania S6		
					Engine Coolant Temperature		
					J1939-Message not available	Mask 8000h	
					Sensor fault	Mask 4000h	
					High Temperature.	Mask 2000h	
					NOT High Temperature	Mask 1000h	
					Engine Oil Pressure		
					J1939-Message not available	Mask 0800h	
					Sensor fault	Mask 0400h	
					Low Pressure	Mask 0200h	
					NOT Low Pressure	Mask 0100h	
					High Engine Oil Level		
					J1939-Message not available	Mask 0080h	
					Sensor fault	Mask 0040h	
					High Level	Mask 0020h	
					NOT High Level	Mask 0010h	
					Low Engine Oil Level		
					J1939-Message not available	Mask 0008h	
					Sensor fault	Mask 0004h	
					Low Level	Mask 0002h	
NOT Low Level	Mask 0001h						
450182	450181	60	3,4	15310	Aftertreatment 1 Diesel Exhaust Fluid Tank Level	0.1	%
450183	450182	60	5,6	15312	Battery Potential, Switched	0.1	V
					1. Active Diagnostic Trouble Code (DM1)		
450184	450183	61	1,2,3,4	15400	SPN		
450186	450185	61	5,6	15401	FMT	Mask FF00h	
				15402	OC	Mask 00FFh	
					2. Active Diagnostic Trouble Code (DM1)		
450187	450186	62	1,2,3,4	15403	SPN		

## Appendix

Data Protocols > CANopen/Modbus > Data Protocol ...

Modbus		CAN		Parameter ID	Description	Multiplier	Units
Modicon start addr.	Start addr. (*1)	Data byte 0 (Mux)	Data byte				
450189	450188	62	5,6	15404	FMT	Mask FF00h	
				15405	OC	Mask 00FFh	
					3. Active Diagnostic Trouble Code (DM1)		
450190	450189	63	1,2,3,4	15406	SPN		
450192	450191	63	5,6	15407	FMT	Mask FF00h	
				15408	OC	Mask 00FFh	
					4. Active Diagnostic Trouble Code (DM1)		
450193	450192	64	1,2,3,4	15409	SPN		
450195	450194	64	5,6	15410	FMT	Mask FF00h	
				15411	OC	Mask 00FFh	
					5. Active Diagnostic Trouble Code (DM1)		
450196	450195	65	1,2,3,4	15412	SPN		
450198	450197	65	5,6	15413	FMT	Mask FF00h	
				15414	OC	Mask 00FFh	
					6. Active Diagnostic Trouble Code (DM1)		
450199	450198	66	1,2,3,4	15415	SPN		
450201	450200	66	5,6	15416	FMT	Mask FF00h	
				15418	OC	Mask 00FFh	
					7. Active Diagnostic Trouble Code (DM1)		
450202	450201	67	1,2,3,4	15419	SPN		
450204	450203	67	5,6	15420	FMT	Mask FF00h	
				15421	OC	Mask 00FFh	
					8. Active Diagnostic Trouble Code (DM1)		
450205	450204	68	1,2,3,4	15422	SPN		
450207	450206	68	5,6	15423	FMT	Mask FF00h	
				15424	OC	Mask 00FFh	
					9. Active Diagnostic Trouble Code (DM1)		
450208	450207	69	1,2,3,4	15425	SPN		

Modbus		CAN		Parameter ID	Description	Multiplier	Units
Modicon start addr.	Start addr. (*1)	Data byte 0 (Mux)	Data byte				
450210	450209	69	5,6	15426	FMT	Mask FF00h	
				15427	OC	Mask 00FFh	
					10. Active Diagnostic Trouble Code (DM1)		
450211	450210	70	1,2,3,4	15428	SPN		
450213	450212	70	5,6	15429	FMT	Mask FF00h	
				15430	OC	Mask 00FFh	
					1. Previously Active Diagnostic Trouble Code (DM2)		
450214	450213	71	1,2,3,4	15450	SPN		
450216	450215	71	5,6	15451	FMT	Mask FF00h	
				15452	OC	Mask 00FFh	
					2. Previously Active Diagnostic Trouble Code (DM2)		
450217	450216	72	1,2,3,4	15453	SPN		
450219	450218	72	5,6	15454	FMT	Mask FF00h	
				15455	OC	Mask 00FFh	
					3. Previously Active Diagnostic Trouble Code (DM2)		
450220	450219	73	1,2,3,4	15456	SPN		
450222	450221	73	5,6	15457	FMT	Mask FF00h	
				15458	OC	Mask 00FFh	
					4. Previously Active Diagnostic Trouble Code (DM2)		
450223	450222	74	1,2,3,4	15459	SPN		
450225	450224	74	5,6	15460	FMT	Mask FF00h	
				15461	OC	Mask 00FFh	
					5. Previously Active Diagnostic Trouble Code (DM2)		
450226	450225	75	1,2,3,4	15462	SPN		
450228	450227	75	5,6	15463	FMT	Mask FF00h	
				15464	OC	Mask 00FFh	
					6. Previously Active Diagnostic Trouble Code (DM2)		
450229	450228	76	1,2,3,4	15465	SPN		

## Appendix

Data Protocols > CANopen/Modbus > Data Protocol ...

Modbus		CAN		Parameter ID	Description	Multiplier	Units
Modicon start addr.	Start addr. (*1)	Data byte 0 (Mux)	Data byte				
450231	450230	76	5,6	15466	FMT	Mask FF00h	
				15467	OC	Mask 00FFh	
					7. Previously Active Diagnostic Trouble Code (DM2)		
450232	450231	77	1,2,3,4	15468	SPN		
450234	450233	77	5,6	15469	FMT	Mask FF00h	
				15470	OC	Mask 00FFh	
					8. Previously Active Diagnostic Trouble Code (DM2)		
450235	450234	78	1,2,3,4	15471	SPN		
450237	450236	78	5,6	15472	FMT	Mask FF00h	
				15473	OC	Mask 00FFh	
					9. Previously Active Diagnostic Trouble Code (DM2)		
450238	450237	79	1,2,3,4	15474	SPN		
450240	450239	79	5,6	15475	FMT	Mask FF00h	
				15476	OC	Mask 00FFh	
					10. Previously Active Diagnostic Trouble Code (DM2)		
450241	450240	80	1,2,3,4	15477	SPN		
450243	450242	80	5,6	15478	FMT	Mask FF00h	
				15479	OC	Mask 00FFh	
450244	450243	81	1,2	15395	DM1 Lamp Status		
					Malfunction Lamp		
					internal	Mask 8000h	
					internal	Mask 4000h	
					On	Mask 2000h	
					Off	Mask 1000h	
					Red Stop Lamp		
					internal	Mask 0800h	
					internal	Mask 0400h	
					On	Mask 0200h	
					Off	Mask 0100h	
					Amber Warning Lamp		
					internal	Mask 0080h	



Modbus		CAN		Parameter ID	Description	Multiplier	Units
Modicon start addr.	Start addr. (*1)	Data byte 0 (Mux)	Data byte				
					internal	Mask 0040h	
					On	Mask 0020h	
					Off	Mask 0010h	
					Protect Lamp		
					internal	Mask 0008h	
					internal	Mask 0004h	
					On	Mask 0002h	
					Off	Mask 0001h	
450245	450244	81	3,4	15445	DM2 Lamp Status		
					Malfunction Lamp		
					internal	Mask 8000h	
					internal	Mask 4000h	
					On	Mask 2000h	
					Off	Mask 1000h	
					Red Stop Lamp		
					internal	Mask 0800h	
					internal	Mask 0400h	
					On	Mask 0200h	
					Off	Mask 0100h	
					Amber Warning Lamp		
					internal	Mask 0080h	
					internal	Mask 0040h	
					On	Mask 0020h	
					Off	Mask 0010h	
					Protect Lamp		
					internal	Mask 0008h	
					internal	Mask 0004h	
					On	Mask 0002h	
					Off	Mask 0001h	
450246	450245	81	5,6	15314	Aftertreatment 1 Diesel Exhaust Fluid Tank Temperature	1	°C
450247	450246	82	1,2,3,4	15200	Engine Speed (j1939-EEC1)	0.1	rpm
450249	450248	82	5,6	15202	Engine Coolant Temp. (J1939-ET1)	1	°C
450250	450249	83	1,2,3,4	15201	Total engine hours (j1939-HOURS)	1	h
450252	450251	83	5,6	15203	Fuel temperature (j1939-ET1)	1	°C

Modbus		CAN		Parameter ID	Description	Multiplier	Units
Modicon start addr.	Start addr. (*1)	Data byte 0 (Mux)	Data byte				
450253	450252	84	1,2,3,4	15204	Engine Oil Temperature (j1939-ET1)	0.01	°C
450255	450254	84	5,6	15205	Engine Oil Pressure (j1939-EFL/P1)	1	kPa
450256	450255	85	1,2,3,4	15211	Fuel Rate (j1939-LFE)	0.01	L/h
450258	450257	85	5,6	15206	Coolant Level (j1939-EFL/P1)	0.1	%
450259	450258	86	1,2	15207	Throttle position (j1939-EEC2)	0.1	%
450260	450259	86	3,4	15208	Load at current Speed (j1939-EEC2)	1	%
450261	450260	86	5,6	15210	Engine oil level (j1939-EFL/P1)	0.1	%
450262	450261	87	1,2	15214	Boost pressure (j1939-IC1)	1	kPa
450263	450262	87	3,4	15215	Intake Manifold Temp (j1939-IC1)	1	°C
450264	450263	87	5,6	15212	Barometric Pressure (j1939-AMB)	0.1	kPa
450265	450264	88	1,2	15213	Air inlet temperature (j1939-AMB)	1	°C
450266	450265	88	3,4	15209	Actual engine torque (j1939-EEC1)	1	%
450267	450266	88	5,6	15315	Aftertreatment 1 Diesel Exhaust Fluid Tank 2 Level	0.1	%
450268	450267	89	1,2,3,4	15216	Exhaust Gas Temp.(J1939-IC1)	0,01	°C
450270	450269	89	5,6	15316	Aftertreatment 1 Diesel Exhaust Fluid Tank 2 Temperature	1	°C

## 9.2.2 CANopen

### 9.2.2.1 Protocol 4103 (J1939 Standard Visualization)

CAN		Parameter ID	Description	Multiplier	Units
Data byte 0 (Mux)	Data byte				
0	1,2		Protocol-ID, always 4103		--
0	3,4		internal		
0	5,6		internal		
			1. Act. Diag. Trouble Code (DM1)		
1	1,2,3,4	15400	SPN		
1	5,6	15401	FMT	Mask FF00h	
		15402	OC	Mask 00FFh	
			2. Act. Diag. Trouble Code (DM1)		
2	1,2,3,4	15403	SPN		
2	5,6	15404	FMT	Mask FF00h	
		15405	OC	Mask 00FFh	
			3. Act. Diag. Trouble Code (DM1)		

CAN		Parameter ID	Description	Multiplier	Units
Data byte 0 (Mux)	Data byte				
3	1,2,3,4	15406	SPN		
3	5,6	15407	FMT	Mask FF00h	
		15408	OC	Mask 00FFh	
			4. Act. Diag. Trouble Code (DM1)		
4	1,2,3,4	15409	SPN		
4	5,6	15410	FMT	Mask FF00h	
		15411	OC	Mask 00FFh	
			5. Act. Diag. Trouble Code (DM1)		
5	1,2,3,4	15412	SPN		
5	5,6	15413	FMT	Mask FF00h	
		15414	OC	Mask 00FFh	
			6. Act. Diag. Trouble Code (DM1)		
6	1,2,3,4	15415	SPN		
6	5,6	15416	FMT	Mask FF00h	
		15418	OC	Mask 00FFh	
			7. Act. Diag. Trouble Code (DM1)		
7	1,2,3,4	15419	SPN		
7	5,6	15420	FMT	Mask FF00h	
		15421	OC	Mask 00FFh	
			8. Act. Diag. Trouble Code (DM1)		
8	1,2,3,4	15422	SPN		
8	5,6	15423	FMT	Mask FF00h	
		15424	OC	Mask 00FFh	
			9. Act. Diag. Trouble Code (DM1)		
9	1,2,3,4	15425	SPN		
9	5,6	15426	FMT	Mask FF00h	
		15427	OC	Mask 00FFh	
			10. Act. Diag. Trouble Code (DM1)		
10	1,2,3,4	15428	SPN		
10	5,6	15429	FMT	Mask FF00h	
		15430	OC	Mask 00FFh	
			1. Previously Act. Diag. Trouble Code (DM2)		
11	1,2,3,4	15450	SPN		
11	5,6	15451	FMT	Mask FF00h	
		15452	OC	Mask 00FFh	

## Appendix

Data Protocols > CANopen > Protocol 4103 (J1939 Stand...

CAN		Parameter ID	Description	Multiplier	Units
Data byte 0 (Mux)	Data byte				
			2. Previously Act. Diag. Trouble Code (DM2)		
12	1,2,3,4	15453	SPN		
12	5,6	15454	FMT	Mask FF00h	
		15455	OC	Mask 00FFh	
			3. Previously Act. Diag. Trouble Code (DM2)		
13	1,2,3,4	15456	SPN		
13	5,6	15457	FMT	Mask FF00h	
		15458	OC	Mask 00FFh	
			4. Previously Act. Diag. Trouble Code (DM2)		
14	1,2,3,4	15459	SPN		
14	5,6	15460	FMT	Mask FF00h	
		15461	OC	Mask 00FFh	
			5. Previously Act. Diag. Trouble Code (DM2)		
15	1,2,3,4	15462	SPN		
15	5,6	15463	FMT	Mask FF00h	
		15464	OC	Mask 00FFh	
			6. Previously Act. Diag. Trouble Code (DM2)		
16	1,2,3,4	15465	SPN		
16	5,6	15466	FMT	Mask FF00h	
		15467	OC	Mask 00FFh	
			7. Previously Act. Diag. Trouble Code (DM2)		
17	1,2,3,4	15468	SPN		
17	5,6	15469	FMT	Mask FF00h	
		15470	OC	Mask 00FFh	
			8. Previously Act. Diag. Trouble Code (DM2)		
18	1,2,3,4	15471	SPN		
18	5,6	15472	FMT	Mask FF00h	
		15473	OC	Mask 00FFh	
			9. Previously Act. Diag. Trouble Code (DM2)		
19	1,2,3,4	15474	SPN		
19	5,6	15475	FMT	Mask FF00h	
		15476	OC	Mask 00FFh	
			10. Previously Act. Diag. Trouble Code (DM2)		
20	1,2,3,4	15477	SPN		
20	5,6	15478	FMT	Mask FF00h	

CAN		Parameter ID	Description	Multiplier	Units
Data byte 0 (Mux)	Data byte				
		15479	OC	Mask 00FFh	
21	1,2	15395	DM1 Lamp Status	Bitmask	
			Malfunction Lamp		
			Missing not supported by the easYgen-3000 Series	Mask 8000h	
			Missing not supported by the easYgen-3000 Series	Mask 4000h	
			On	Mask 2000h	
			Off	Mask 1000h	
			Red Stop Lamp		
			Missing not supported by the easYgen-3000 Series	Mask 0800h	
			Missing not supported by the easYgen-3000 Series	Mask 0400h	
			On	Mask 0200h	
			Off	Mask 0100h	
			Amber Warning Lamp		
			Missing not supported by the easYgen-3000 Series	Mask 0080h	
			Missing not supported by the easYgen-3000 Series	Mask 0040h	
			On	Mask 0020h	
			Off	Mask 0010h	
			Protect Lamp Status		
			Missing not supported by the easYgen-3000 Series	Mask 0008h	
			Missing not supported by the easYgen-3000 Series	Mask 0004h	
			On	Mask 0002h	
			Off	Mask 0001h	
21	3,4	15445	DM2 Lamp Status	Bitmask	
			Malfunction Lamp		
			Missing not supported by the easYgen-3000 Series	Mask 8000h	
			Missing not supported by the easYgen-3000 Series	Mask 4000h	
			On	Mask 2000h	
			Off	Mask 1000h	
			Red Stop Lamp		

## Appendix

Data Protocols > CANopen > Protocol 4103 (J1939 Stand...

CAN		Parameter ID	Description	Multiplier	Units
Data byte 0 (Mux)	Data byte				
			Missing not supported by the easYgen-3000 Series	Mask 0800h	
			Missing not supported by the easYgen-3000 Series	Mask 0400h	
			On	Mask 0200h	
			Off	Mask 0100h	
			Amber Warning Lamp		
			Missing not supported by the easYgen-3000 Series	Mask 0080h	
			Missing not supported by the easYgen-3000 Series	Mask 0040h	
			On	Mask 0020h	
			Off	Mask 0010h	
			Protect Lamp Status		
			Missing not supported by the easYgen-3000 Series	Mask 0008h	
			Missing not supported by the easYgen-3000 Series	Mask 0004h	
			On	Mask 0002h	
			Off	Mask 0001h	
22	1,2,3,4	15200	Engine Speed (j1939)	0,1	rpm
22	5,6	15202	Engine Coolant Temperature (J1939)	1	°C
23	1,2,3,4	15201	Total engine hours (j1939)	1	h
23	5,6	15203	Fuel temperature (j1939)	1	°C
24	1,2,3,4	15204	Engine Oil Temperature (j1939)	0,1	°C
24	5,6	15205	Engine Oil Pressure (j1939)	1	kPa
25	1,2,3,4	15211	Fuel Rate (j1939)	0,01	L/h
25	5,6	15206	Coolant Level (j1939)	0,1	%
26	1,2	15207	Throttle position (j1939)	0,1	%
26	3,4	15208	Load at current Speed (j1939)	1	%
26	5,6	15210	Engine oil level (j1939)	0,1	%
27	1,2	15214	Boost pressure (j1939)	1	kPa
27	3,4	15215	Intake Manifold Temp (j1939)	1	°C
27	5,6	15212	Barometric Pressure (j1939)	0,1	kPa
28	1,2	15213	Air inlet temperature (j1939)	1	°C
28	3,4	15209	Actual engine torque (j1939)	1	%
28	5,6		internal		

CAN		Parameter ID	Description	Multiplier	Units
Data byte 0 (Mux)	Data byte				
29	1,2,3,4	15216	Exhaust Gas Temp.	0,01	°C
29	5,6		internal		

### 9.2.2.2 Protocol 4104 (J1939 Scania S6 Visualization)

CAN		Parameter ID	Description	Multiplier	Units
Data byte 0 (Mux)	Data byte				
0	1,2		Protocol-ID, always 4104		--
0	3,4		internal		
0	5,6		internal		
1	1,2	15305	J1939 DLN2-Message S6	Bitmask	
			not available	Mask 8000h	
			sensor fault	Mask 4000h	
			yes	Mask 2000h	
			High Engine Coolant Temp. - no	Mask 1000h	
			not available	Mask 0800h	
			sensor fault	Mask 0400h	
			yes	Mask 0200h	
			Low Oil Pressure - no	Mask 0100h	
			not available	Mask 0080h	
			sensor fault	Mask 0040h	
			yes	Mask 0020h	
			High Engine Oil Level - no	Mask 0010h	
			not available	Mask 0008h	
			sensor fault	Mask 0004h	
			yes	Mask 0002h	
			Low Engine Oil Level - no	Mask 0001h	
1	3,4		internal		
1	5,6		internal		

9.2.2.3 Protocol 4105 (J1939 Deutz EMR2 Visualization)

CAN		Parameter ID	Description	Multiplier	Units
Data byte 0 (Mux)	Data byte				
0	1,2		Protocol-ID, always 4105		--
0	3,4		internal		
0	5,6		internal		
1	1,2	15304	J1939 Engine Stop Information EMR2	1	
			0 No shutdown		
			1 Engine protection		
			2 CAN message Engine Stop Request		
			3 Oil pressure low		
			4 Oil level low		
			5 Coolant temperature high		
			6 Coolant level low		
			7 Charge air temperature		
			8 internal		
			9 internal		
			FEFFh Sensor fault		
			FFFFh Not available		
1	3,4		internal		
1	5,6		internal		

9.2.2.4 Protocol 4110 (J1939 MTU ADEC Visualization)

CAN		Parameter ID	Description	Multiplier	Units
Data byte 0 (Mux)	Data byte				
0	1,2		Protocoll-ID, allways 4110		--
0	3,4		internal		
0	5,6		internal		
1	1,2	15109	J1939 MTU ADEC ECU Failure Codes	1	
1	3,4		internal		
1	5,6		internal		



## 9.2.2.5 Protocol 5004 (Generator Values Visualization)

CAN		Parameter ID	Description	Multiplier	Units
Data byte 0 (Mux)	Data byte				
0	1,2		Protocol ID, always 5004		--
0	3,4	10100	Pickup speed	1	rpm
0	5,6	-	internal		
1	1,2	160	Gen. power factor	0.001	
1	3,4,5,6	170	Av. Gen. Wye-Voltage	0.1	V
2	1,2	144	Gen. frequency	0.01	Hz
2	3,4,5,6	171	Av. Gen. Delta-Voltage	0.1	V
3	1,2	10310	Analog output 1	0,01	%
3	3,4,5,6	185	Av. Gen. Current	0.001	A
4	1,2	10311	Analog output 2	0,01	%
4	3,4,5,6	161	Meas. ground current	0.001	A
5	1,2	2112	Overspeed 1 latched	Mask: 8000h	Bit
		2113	Overspeed 2 latched	Mask: 4000h	Bit
		2162	Underspeed 1 latched	Mask: 2000h	Bit
		2163	Underspeed 2 latched	Mask: 1000h	Bit
		2652	Unintended stop latched	Mask: 0800h	Bit
		2457	Speed det. alarm latched	Mask: 0400h	Bit
		2504	Shutdown malfunction latched	Mask: 0200h	Bit
		2603	GCB fail to close latched	Mask: 0100h	Bit
		2604	GCB fail to open latched	Mask: 0080h	Bit
		2623	MCB fail to close latched	Mask: 0040h	Bit
		2624	MCB fail to open latched	Mask: 0020h	Bit
		10017	CAN-Fault J1939 latched	Mask: 0010h	Bit
		3325	Start fail latched	Mask: 0008h	Bit
		2560	Maintenance days exceeded latched	Mask: 0004h	Bit
		2561	Maintenance hours exceeded latched	Mask: 0002h	Bit
10087	CANopen error at CAN Interface 1	Mask: 0001h	Bit		
5	3,4,5,6	159	Calculated ground current	0.001	A
6	1,2	3064	GCB syn. timeout latched	Mask: 8000h	Bit
		3074	MCB syn. timeout latched	Mask: 4000h	Bit
		3084	reserved	Mask: 2000h	Bit
		4056	Charge alt. low volt latched	Mask: 1000h	Bit
		2944	Ph.rotation mismatch latched	Mask: 0800h	Bit
		10084	no data receive at RPDO3 at CAN Interface 1	Mask: 0400h	Bit

## Appendix

Data Protocols > CANopen > Protocol 5004 (Generator V...

CAN		Parameter ID	Description	Multiplier	Units
Data byte 0 (Mux)	Data byte				
		10083	no data receive at RPDO2 at CAN Interface 1	Mask: 0200h	Bit
		10082	no data receive at RPDO1 at CAN Interface 1	Mask: 0100h	Bit
		10086	no data receive at RPDO2 (function 1) at CAN Interface 2	Mask: 0080h	Bit
		10085	no data receive at RPDO1 (function 1) at CAN Interface 2	Mask: 0040h	Bit
		10088	CANopen error at CAN Interface 2	Mask: 0020h	Bit
		4073	Parameter Alignment	Mask: 0010h	
		4064	Missing members on CAN	Mask: 0008h	
		1714	EEPROM failure latched	Mask: 0004h	Bit
		15125	Red stop lamp latched	Mask: 0002h	Bit
		15126	Amber warning lamp latched	Mask: 0001h	Bit
6	3,4,5,6	111	Gen. current 1	0.001	A
7	1,2,3,4	112	Gen. current 2	0.001	A
7	5,6	-	internal		
8	1,2,3,4	113	Gen. current 3	0.001	A
8	5,6	-	internal		
9	1,2,3,4	135	Total gen. power	1	W
9	5,6	1912	Gen.overfreq. 1 latched	Mask: 8000h	Bit
		1913	Gen.overfreq. 2 latched	Mask: 4000h	Bit
		1962	Gen.underfreq. 1 latched	Mask: 2000h	Bit
		1963	Gen.underfreq. 2 latched	Mask: 1000h	Bit
		2012	Gen.overnvolt. 1 latched	Mask: 0800h	Bit
		2013	Gen.overnvolt. 2 latched	Mask: 0400h	Bit
		2062	Gen.undervolt. 1 latched	Mask: 0200h	Bit
		2063	Gen.undervolt. 2 latched	Mask: 0100h	Bit
		2218	Gen. overcurr. 1 latched	Mask: 0080h	Bit
		2219	Gen. overcurr. 2 latched	Mask: 0040h	Bit
		2220	Gen. overcurr. 3 latched	Mask: 0020h	Bit
		2262	Gen. Rv/Rd pow.1 latched	Mask: 0010h	Bit
		2263	Gen. Rv/Rd pow.2 latched	Mask: 0008h	Bit
		2314	Gen. Overload IOP 1 latched	Mask: 0004h	Bit
		2315	Gen. Overload IOP 2 latched	Mask: 0002h	Bit
		-	internal	Mask: 0001h	
10	1,2,3,4	136	Total gen. reactive power	1	var
10	5,6	2412	Unbal. load 1 latched	Mask: 8000h	Bit
		2413	Unbal. load 2 latched	Mask: 4000h	Bit

CAN		Parameter ID	Description	Multiplier	Units
Data byte 0 (Mux)	Data byte				
		3907	Gen. Asymmetry latched	Mask: 2000h	Bit
		3263	Ground fault 1 latched	Mask: 1000h	Bit
		3264	Ground fault 2 latched	Mask: 0800h	Bit
		3955	Gen. phase rot. misw. Latched	Mask: 0400h	Bit
		2924	Gen act.pwr mismatch Latched	Mask: 0200h	Bit
		3124	Gen. unloading fault Latched	Mask: 0100h	Bit
		4038	Inv.time ov.curr. Latched	Mask: 0080h	Bit
		2644	Timeout dead bus op. Latched	Mask: 0040h	Bit
		2362	Gen. Overload MOP 1 latched	Mask: 0020h	Bit
		2363	Gen. Overload MOP 2 latched	Mask: 0010h	Bit
		2337	Gen. overexcited 1 latched	Mask: 0008h	Bit
		2338	Gen. overexcited 2 latched	Mask: 0004h	Bit
		2387	Gen. underexcited 1 latched	Mask: 0002h	Bit
		2388	Gen. underexcited 2 latched	Mask: 0001h	Bit
11	1,2,3,4	108	Gen. voltage L1-L2	0.1	V
11	5,6	10131	control class latched	Mask: 0040h	Bit
			Alarm class F latched	Mask: 0020h	Bit
			Alarm class E latched	Mask: 0010h	Bit
			Alarm class D latched	Mask: 0008h	Bit
			Alarm class C latched	Mask: 0004h	Bit
			Alarm class B latched	Mask: 0002h	Bit
			Alarm class A latched	Mask: 0001h	Bit
12	1,2	4153	Idle mode monitoring (suppresses undervolt, underfreq,...)	Mask: 8000h	
			Idle mode active	Mask: 4000h	
			Start without closing GCB	Mask: 2000h	
			internal	Mask: 1000h	
			A manual START has been requested	Mask: 0800h	
			A manual START has been requested	Mask: 0400h	
			Cooldown is active	Mask: 0200h	
			Auxiliary services generally active	Mask: 0100h	
			Engine monitoring delay timer has expired	Mask: 0080h	
			Breaker delay timer has expired	Mask: 0040h	
			Engine start is requested	Mask: 0020h	
			Critical mode is active in automatic mode	Mask: 0010h	
Engine is released (speed governor is enabled)	Mask: 0008h				

## Appendix

Data Protocols > CANopen > Protocol 5004 (Generator V...

CAN		Parameter ID	Description	Multiplier	Units
Data byte 0 (Mux)	Data byte				
			Auxiliary services prerun is active	Mask: 0004h	
			Auxiliary services postrun is active	Mask: 0002h	
			Lamp test is active	Mask: 0001h	
12	3,4,5,6	114	Gen. voltage L1-N	0.1	V
13	1,2,3,4	109	Gen. voltage L2-L3	0.1	V
13	5,6	-	internal		
14	1,2,3,4	115	Gen. voltage L2-N	0.1	V
14	5,6	-	internal		
15	1,2,3,4	110	Gen. voltage L3-L1	0.1	V
15	5,6	-	internal		
16	1,2,3,4	116	Gen. voltage 3-N	0.1	V
16	5,6	-	internal		
17	1,2,3,4	2522	Positive reactive generator energy	0,01	Mvar h
17	5,6	-	internal		
18	1,2	5541	Frequency setpoint	0,01	Hz
18	3,4,5,6	5542	Active Power setpoint	0,1	kW
19	1,2,3,4	5640	Voltage setpoint	1	V
19	5,6	5641	Power Factor setpoint	0,001	
20	1,2	4154	Crank (Starter) is active	Mask: 8000h	
			Operating Magnet / Gas relay is active	Mask: 4000h	
			Preglow / Ignition is active	Mask: 2000h	
			Mains settling timer is running	Mask: 1000h	
			Emergency mode is currently active	Mask: 0800h	
			internal	Mask: 0400h	
			Emergency Mains overfrequency	Mask: 0200h	
			Emergency Mains underfrequency	Mask: 0100h	
			Emergency Mains overvoltage	Mask: 0080h	
			Emergency Mains undervoltage	Mask: 0040h	
			Stopping Magnet is active	Mask: 0020h	
			internal	Mask: 0010h	
			The genset runs mains parallel	Mask: 0008h	
			internal	Mask: 0004h	
internal	Mask: 0002h				
Increment Engine Start Counter	Mask: 0001h				
20	3,4	4155	3-Position Controller Freq./Power raise	Mask: 8000h	

CAN		Parameter ID	Description	Multiplier	Units
Data byte 0 (Mux)	Data byte				
			3-Position Controller Freq./Power lower	Mask: 4000h	
			3-Position Controller Volt./ReactPow raise	Mask: 2000h	
			3-Position Controller Volt./ReactPow lower	Mask: 1000h	
			GCB is closed	Mask: 0800h	
			MCB is closed	Mask: 0400h	
			internal	Mask: 0200h	
			Synchronization GCB is active	Mask: 0100h	
			Opening GCB is active	Mask: 0080h	
			Closing GCB is active	Mask: 0040h	
			Synchronization MCB is active	Mask: 0020h	
			Opening MCB is active	Mask: 0010h	
			Closing MCB is active	Mask: 0008h	
			Unloading generator is active	Mask: 0004h	
			Unloading mains is active	Mask: 0002h	
			Power limited prerun	Mask: 0001h	
20	5,6	4156	internal	Mask: 8000h	
			internal	Mask: 4000h	
			internal	Mask: 2000h	
			internal	Mask: 1000h	
			internal	Mask: 0800h	
			Dead busbar closure request for GCB or MCB	Mask: 0400h	
			Active power load share is active	Mask: 0200h	
			Reactive power load share is active	Mask: 0100h	
			Generator with a closed GCB is requested	Mask: 0080h	
			LDSS will start this engine	Mask: 0040h	
			LDSS will stop this engine	Mask: 0020h	
			LDSS will stop this engine if possible	Mask: 0010h	
			LDSS Minimum Running Time is active	Mask: 0008h	
			LDSS is active	Mask: 0004h	
			Critical Mode Postrun is active	Mask: 0002h	
			internal	Mask: 0001h	

9.2.2.6 Protocol 5005 (Mains Values Visualization)

CAN		Parameter ID	Description	Multiplier	Units
Data byte 0 (Mux)	Data byte				
0	1,2	-	Protocol ID (always 5005)		--
0	3,4	10100	Pickup speed	1	rpm
0	5,6	-	internal		
1	1,2	147	Mains frequency	0.01	Hz
1	3,4,5,6	173	Av. Mains Wye-Voltage	0.1	V
2	1,2	208	Mains power factor	0.001	
2	3,4,5,6	174	Av. Mains Delta-Voltage	0.1	V
3	1,2,3,4	207	Av. Mains Current	0.1	V
3	5,6	-	internal		
4	1,2	10111	Analog input 1	(changeable)	
4	3,4,5,6	134	Mains current L1	0.001	A
5	1,2	10112	Analog input 2	(changeable)	
5	3,4,5,6	140	Total mains power	1	W
6	1,2	10115	Analog input 3	(changeable)	
6	3,4,5,6	150	Total mains reactive power	1	var
7	1,2	2862	Mains ov.freq. 1 latched	Mask: 8000h	Bit
		2863	Mains ov.freq. 2 latched	Mask: 4000h	Bit
		2912	Mains un.freq. 1 latched	Mask: 2000h	Bit
		2913	Mains un.freq. 2 latched	Mask: 1000h	Bit
		2962	Mains ov.volt. 1 latched	Mask: 0800h	Bit
		2963	Mains ov.volt. 2 latched	Mask: 0400h	Bit
		3012	Mains un.volt. 1 latched	Mask: 0200h	Bit
		3013	Mains un.volt. 2 latched	Mask: 0100h	Bit
		3057	Mains phase shift latched	Mask: 0080h	Bit
		3114	Mains decoupling latched	Mask: 0040h	Bit
		-	internal	Mask: 0020h	Bit
		-	internal	Mask: 0010h	Bit
		-	internal	Mask: 0008h	Bit
		3975	Mains phase rot. miswired latched	Mask: 0004h	Bit
		-	internal	Mask: 0002h	Bit
-	internal	Mask: 0001h	Bit		
7	3,4	3217	Mains import power 1 latched	Mask: 8000h	Bit
		3218	Mains import power 2 latched	Mask: 4000h	Bit
		3241	Mains export power 1 latched	Mask: 2000h	Bit

CAN		Parameter ID	Description	Multiplier	Units
Data byte 0 (Mux)	Data byte				
		3242	Mains export power 2 latched	Mask: 1000h	Bit
		2985	Mains overexcited 1 latched	Mask: 0800h	Bit
		2986	Mains overexcited 2 latched	Mask: 0400h	Bit
		3035	Mains underexcited 1 latched	Mask: 0200h	Bit
		3036	Mains underexcited 2 latched	Mask: 0100h	Bit
		3106	Mains df/dt latched	Mask: 0080h	Bit
		2934	Mains act.pwr mismatch latched	Mask: 0040h	Bit
		4958	Mains. Time dep. Voltage latched	Mask: 0020h	Bit
		-	internal	Mask: 0010h	Bit
		8834	Mains Voltage Increase latched	Mask: 0008h	Bit
		-	internal	Mask: 0004h	Bit
		3288	Mains QV Monitoring step 1 latched	Mask: 0002h	Bit
		3289	Mains QV Monitoring step 2 latched	Mask: 0001h	Bit
7	5,6	-	internal		
8	1,2,3,4	118	Mains voltage L1-L2	0.1	V
8	5,6	-	internal		
9	1,2,3,4	121	Mains voltage L1-N	0.1	V
9	5,6	-	internal		
10	1,2,3,4	119	Mains voltage L2-L3	0.1	V
10	5,6	-	internal		
11	1,2,3,4	122	Mains voltage L2-N	0.1	V
11	5,6	-	internal		
12	1,2,3,4	120	Mains voltage L3-L1	0.1	V
12	5,6	-	internal		
13	1,2,3,4	123	Mains voltage L3-N	0.1	V
13	5,6	-	internal		

9.2.2.7 Protocol 5011 (Alarm Values Visualization)



**P2** only: ... " Applies to easYgen-3100/3200 Package P2 only.

CAN		Parameter ID	Description	Multiplier	Units
Data byte 0 (Mux)	Data byte				
0	1,2		Protocol-ID, always 5011		--
<b>Generator</b>					
0	3,4	-	Alarms Generator active		
		1912	Gen.overfreq. 1	Mask: 8000h	Bit
		1913	Gen.overfreq. 2	Mask: 4000h	Bit
		1962	Gen.underfreq. 1	Mask: 2000h	Bit
		1963	Gen.underfreq. 2	Mask: 1000h	Bit
		2012	Gen.overnvolt. 1	Mask: 0800h	Bit
		2013	Gen.overnvolt. 2	Mask: 0400h	Bit
		2062	Gen.undervolt. 1	Mask: 0200h	Bit
		2063	Gen.undervolt. 2	Mask: 0100h	Bit
		2218	Gen. overcurr. 1	Mask: 0080h	Bit
		2219	Gen. overcurr. 2	Mask: 0040h	Bit
		2220	Gen. overcurr. 3	Mask: 0020h	Bit
		2262	Gen. Rv/Rd pow.1	Mask: 0010h	Bit
		2263	Gen. Rv/Rd pow.2	Mask: 0008h	Bit
		2314	Gen. Overload IOP 1	Mask: 0004h	Bit
		2315	Gen. Overload IOP 2	Mask: 0002h	Bit
			internal	Mask: 0001h	Bit
0	5,6	10134	Alarms Generator latched (unacknowledged)		
		1912	Gen.overfreq. 1	Mask: 8000h	Bit
		1913	Gen.overfreq. 2	Mask: 4000h	Bit
		1962	Gen.underfreq. 1	Mask: 2000h	Bit
		1963	Gen.underfreq. 2	Mask: 1000h	Bit
		2012	Gen.overnvolt. 1	Mask: 0800h	Bit
		2013	Gen.overnvolt. 2	Mask: 0400h	Bit
		2062	Gen.undervolt. 1	Mask: 0200h	Bit
		2063	Gen.undervolt. 2	Mask: 0100h	Bit
		2218	Gen. overcurr. 1	Mask: 0080h	Bit



CAN		Parameter ID	Description	Multiplier	Units
Data byte 0 (Mux)	Data byte				
		2219	Gen. overcurr. 2	Mask: 0040h	Bit
		2220	Gen. overcurr. 3	Mask: 0020h	Bit
		2262	Gen. Rv/Rd pow.1	Mask: 0010h	Bit
		2263	Gen. Rv/Rd pow.2	Mask: 0008h	Bit
		2314	Gen. Overload IOP 1	Mask: 0004h	Bit
		2315	Gen. Overload IOP 2	Mask: 0002h	Bit
			internal	Mask: 0001h	Bit
1	1,2	-	Alarms Generator 1 active		
		2412	Unbal. load 1	Mask: 8000h	Bit
		2413	Unbal. load 2	Mask: 4000h	Bit
		3907	Gen. Asymmetry	Mask: 2000h	Bit
		3263	Ground fault 1	Mask: 1000h	Bit
		3264	Ground fault 2	Mask: 0800h	Bit
		3955	Gen. phase rot. misw.	Mask: 0400h	Bit
		2924	Gen act.pwr mismatch	Mask: 0200h	Bit
		3124	Gen. unloading fault	Mask: 0100h	Bit
		4038	Inv.time ov.curr.	Mask: 0080h	Bit
		2664	Operating range failed,	Mask: 0040h	Bit
		2362	Gen. Overload MOP 1	Mask: 0020h	Bit
		2363	Gen. Overload MOP 2	Mask: 0010h	Bit
		2337	Gen. overexcited 1	Mask: 0008h	Bit
		2338	Gen. overexcited 2	Mask: 0004h	Bit
		2387	Gen. underexcited 1	Mask: 0002h	Bit
		2388	Gen. underexcited 2	Mask: 0001h	Bit
1	3,4	10138	Alarms Generator 1 latched (unacknowledged)		
		2412	Unbal. load 1	Mask: 8000h	Bit
		2413	Unbal. load 2	Mask: 4000h	Bit
		3907	Gen. Asymmetry	Mask: 2000h	Bit
		3263	Ground fault 1	Mask: 1000h	Bit
		3264	Ground fault 2	Mask: 0800h	Bit
		3955	Gen. phase rot. misw.	Mask: 0400h	Bit
		2924	Gen act.pwr mismatch	Mask: 0200h	Bit
		3124	Gen. unloading fault	Mask: 0100h	Bit
		4038	Inv.time ov.curr.	Mask: 0080h	Bit
		2664	Operating range failed	Mask: 0040h	Bit

## Appendix

Data Protocols > CANopen > Protocol 5011 (Alarm Value...

CAN		Parameter ID	Description	Multiplier	Units
Data byte 0 (Mux)	Data byte				
		2362	Gen. Overload MOP 1	Mask: 0020h	Bit
		2363	Gen. Overload MOP 2	Mask: 0010h	Bit
		2337	Gen. overexcited 1	Mask: 0008h	Bit
		2338	Gen. overexcited 2	Mask: 0004h	Bit
		2387	Gen. underexcited 1	Mask: 0002h	Bit
		2388	Gen. underexcited 2	Mask: 0001h	Bit
1	5,6	10131	Alarm classes latched (unacknowledged)		
			Control	Mask: 0040h	Bit
			Class F	Mask: 0020h	Bit
			Class E	Mask: 0010h	Bit
			Class D	Mask: 0008h	Bit
			Class C	Mask: 0004h	Bit
			Class B	Mask: 0002h	Bit
			Class A	Mask: 0001h	Bit
<b>Mains</b>					
2	1,2	4188	Alarms Mains active		
		2862	Mains ov.freq. 1	Mask: 8000h	Bit
		2863	Mains ov.freq. 2	Mask: 4000h	Bit
		2912	Mains un.freq. 1	Mask: 2000h	Bit
		2913	Mains un.freq. 2	Mask: 1000h	Bit
		2962	Mains ov.volt. 1	Mask: 0800h	Bit
		2963	Mains ov.volt. 2	Mask: 0400h	Bit
		3012	Mains un.volt. 1	Mask: 0200h	Bit
		3013	Mains un.volt. 2	Mask: 0100h	Bit
		3057	Mains phaseshift	Mask: 0080h	Bit
		3114	Mains decoupling	Mask: 0040h	Bit
			internal	Mask: 0020h	Bit
			internal	Mask: 0010h	Bit
			internal	Mask: 0008h	Bit
		3975	Mains phase rot. Miswired	Mask: 0004h	Bit
			internal	Mask: 0002h	Bit
			internal	Mask: 0001h	Bit
2	3,4	10135	Alarms Mains latched (unacknowledged)		
		2862	Mains ov.freq. 1	Mask: 8000h	Bit
		2863	Mains ov.freq. 2	Mask: 4000h	Bit

CAN		Parameter ID	Description	Multiplier	Units
Data byte 0 (Mux)	Data byte				
		2912	Mains un.freq. 1	Mask: 2000h	Bit
		2913	Mains un.freq. 2	Mask: 1000h	Bit
		2962	Mains ov.volt. 1	Mask: 0800h	Bit
		2963	Mains ov.volt. 2	Mask: 0400h	Bit
		3012	Mains un.volt. 1	Mask: 0200h	Bit
		3013	Mains un.volt. 2	Mask: 0100h	Bit
		3057	Mains phaseshift	Mask: 0080h	Bit
		3114	Mains decoupling	Mask: 0040h	Bit
			internal	Mask: 0020h	Bit
			internal	Mask: 0010h	Bit
			internal	Mask: 0008h	Bit
		3975	Mains phase rot. Miswired	Mask: 0004h	Bit
			internal	Mask: 0002h	Bit
			internal	Mask: 0001h	Bit
2	5,6		reserved		
3	1,2	4189	Alarms Mains 1 active		
		3217	Mains import power 1	Mask: 8000h	Bit
		3218	Mains import power 2	Mask: 4000h	Bit
		3241	Mains export power 1	Mask: 2000h	Bit
		3242	Mains export power 2	Mask: 1000h	Bit
		2985	Mains overexcited 1	Mask: 0800h	Bit
		2986	Mains overexcited 2	Mask: 0400h	Bit
		3035	Mains underexcited 1	Mask: 0200h	Bit
		3036	Mains underexcited 2	Mask: 0100h	Bit
		3106	Mains df/dt	Mask: 0080h	Bit
		2934	Mns act.pwr mismatch	Mask: 0040h	Bit
		4958	Mains. Time dep. Voltage	Mask: 0020h	Bit
			internal	Mask: 0010h	Bit
		8834	Mains Voltage Increase	Mask: 0008h	Bit
			internal	Mask: 0004h	Bit
		3288	Mains QV Monitoring step 1	Mask: 0002h	Bit
		3289	Mains QV Monitoring step 2	Mask: 0001h	Bit
3	3,4	4189	Alarms Mains 1 latched (unacknowledged)		
		3217	Mains import power 1	Mask: 8000h	Bit
		3218	Mains import power 2	Mask: 4000h	Bit

## Appendix

Data Protocols > CANopen > Protocol 5011 (Alarm Value...

CAN		Parameter ID	Description	Multiplier	Units
Data byte 0 (Mux)	Data byte				
		3241	Mains export power 1	Mask: 2000h	Bit
		3242	Mains export power 2	Mask: 1000h	Bit
		2985	Mains overexcited 1	Mask: 0800h	Bit
		2986	Mains overexcited 2	Mask: 0400h	Bit
		3035	Mains underexcited 1	Mask: 0200h	Bit
		3036	Mains underexcited 2	Mask: 0100h	Bit
		3106	Mains df/dt	Mask: 0080h	Bit
		2934	Mns act.pwr mismatch	Mask: 0040h	Bit
		4958	Mains. Time dep. Voltage	Mask: 0020h	Bit
			internal	Mask: 0010h	Bit
		8834	Mains Voltage Increase	Mask: 0008h	Bit
			internal	Mask: 0004h	Bit
		3288	Mains QV Monitoring step 1	Mask: 0002h	Bit
		3289	Mains QV Monitoring step 2	Mask: 0001h	Bit
3	5,6		reserved		
<b>Engine</b>					
4	1,2	-	Alarms 1 active		
		2112	Overspeed 1	Mask: 8000h	Bit
		2113	Overspeed 2	Mask: 4000h	Bit
		2162	Underspeed 1	Mask: 2000h	Bit
		2163	Underspeed 2	Mask: 1000h	Bit
		2652	Unintended stop	Mask: 0800h	Bit
		2457	Speed det. alarm	Mask: 0400h	Bit
		2504	Shutdwn malfunct.	Mask: 0200h	Bit
		2603	GCB fail to close	Mask: 0100h	Bit
		2604	GCB fail to open	Mask: 0080h	Bit
		2623	MCB fail to close	Mask: 0040h	Bit
		2624	MCB fail to open	Mask: 0020h	Bit
		10017	CAN-Fault J1939	Mask: 0010h	Bit
		3325	Start fail	Mask: 0008h	Bit
		2560	Mainten. days exceeded	Mask: 0004h	Bit
		2561	Mainten. hours exceeded	Mask: 0002h	Bit
		10087	CANopen error at CAN Interface 1	Mask: 0001h	Bit
4	3,4	10133	Alarms 1 latched (unacknowledged)		
		2112	Overspeed 1	Mask: 8000h	Bit

CAN		Parameter ID	Description	Multiplier	Units
Data byte 0 (Mux)	Data byte				
		2113	Overspeed 2	Mask: 4000h	Bit
		2162	Underspeed 1	Mask: 2000h	Bit
		2163	Underspeed 2	Mask: 1000h	Bit
		2652	Unintended stop	Mask: 0800h	Bit
		2457	Speed det. Alarm	Mask: 0400h	Bit
		2504	Shutdwn malfunc.	Mask: 0200h	Bit
		2603	GCB fail to close	Mask: 0100h	Bit
		2604	GCB fail to open	Mask: 0080h	Bit
		2623	MCB fail to close	Mask: 0040h	Bit
		2624	MCB fail to open	Mask: 0020h	Bit
		10017	CAN-Fault J1939	Mask: 0010h	Bit
		3325	Start fail	Mask: 0008h	Bit
		2560	Mainten. days exceeded	Mask: 0004h	Bit
		2561	Mainten. hours exceeded	Mask: 0002h	Bit
		10087	CANopen error at CAN Interface 1	Mask: 0001h	Bit
4	5,6		Alarms 3 active		
		3089	internal	Mask: 8000h	Bit
		3090	internal	Mask: 4000h	Bit
		14575	Temperature deviation level 1	Mask: 0800h	Bit
		14576	Temperature deviation level 2	Mask: 0400h	Bit
		14584	Temperature deviation wire break	Mask: 0200h	Bit
5	1,2	-	Alarms 2 active		
		3064	GCB syn. Timeout	Mask: 8000h	Bit
		3074	MCB syn. Timeout	Mask: 4000h	Bit
		3084	internal	Mask: 2000h	Bit
		4056	Charge alt. low voltage (D+)	Mask: 1000h	Bit
		2944	Phase rotation mismatch	Mask: 0800h	Bit
		10084	CAN overload	Mask: 0400h	Bit
			internal	Mask: 0200h	Bit
			internal	Mask: 0100h	Bit
			internal	Mask: 0080h	Bit
			internal	Mask: 0040h	Bit
		10088	CANopen error at CAN Interface 2	Mask: 0020h	Bit
		4073	Parameter Alignment	Mask: 0010h	Bit
		4064	Missing members on CAN	Mask: 0008h	Bit

## Appendix

Data Protocols > CANopen > Protocol 5011 (Alarm Value...

CAN		Parameter ID	Description	Multiplier	Units
Data byte 0 (Mux)	Data byte				
		1714	EEPROM failure	Mask: 0004h	Bit
		15125	Red stop lamp DM1	Mask: 0002h	Bit
		15126	Amber warning lamp DM1	Mask: 0001h	Bit
5	3,4	10149	Alarms 2 latched (unacknowledged)		
		3064	GCB sync. Timeout	Mask: 8000h	Bit
		3074	MCB sync. Timeout	Mask: 4000h	Bit
		3084	internal	Mask: 2000h	Bit
		4056	Charge alt. low voltage (D+)	Mask: 1000h	Bit
		2944	Phase rotation mismatch	Mask: 0800h	Bit
		1009	CAN overload	Mask: 0400h	Bit
			internal	Mask: 0200h	Bit
			internal	Mask: 0100h	Bit
			internal	Mask: 0080h	Bit
			internal	Mask: 0040h	Bit
		10088	CANopen error at CAN Interface 2	Mask: 0020h	Bit
		4073	Parameter Alignment	Mask: 0010h	Bit
		4064	Missing members on CAN	Mask: 0008h	Bit
		1714	EEPROM failure	Mask: 0004h	Bit
		15125	Red stop lamp DM1	Mask: 0002h	Bit
		15126	Amber warning lamp DM1	Mask: 0001h	Bit
5	5,6		reserved		
			internal	Mask: 8000h	Bit
			internal	Mask: 4000h	Bit
			internal	Mask: 2000h	Bit
			internal	Mask: 1000h	Bit
		14575	Temperature deviation level 1	Mask: 0800h	Bit
		14576	Temperature deviation level 2	Mask: 0400h	Bit
		14584	Temperature deviation wire break	Mask: 0200h	Bit
			internal	Mask: 0100h	Bit
			internal	Mask: 0080h	Bit
			internal	Mask: 0040h	Bit
			internal	Mask: 0020h	Bit
			internal	Mask: 0010h	Bit
			internal	Mask: 0008h	Bit
			internal	Mask: 0004h	Bit

CAN		Parameter ID	Description	Multiplier	Units
Data byte 0 (Mux)	Data byte				
			internal	Mask: 0002h	Bit
			internal	Mask: 0001h	Bit
<b>Alarms</b>					
6	1,2		Alarms active		
		5183	Free alarm 4	Mask: 2000h	Bit
		5177	Free alarm 3	Mask: 1000h	Bit
		5171	Free alarm 2	Mask: 0800h	Bit
		5165	Free alarm 1	Mask: 0400h	Bit
		5159	Max. starts per time	Mask: 0200h	Bit
		5153	Neutral contactor failure	Mask: 0100h	Bit
		5147	Decoupling GCB↔MCB	Mask: 0080h	Bit
		5141	Meas.difference 4105 VDE-AR-N 4105	Mask: 0040h	Bit
		5135	Parameter alignment VDE-AR-N 4105	Mask: 0020h	Bit
		5129	Missing member VDE-AR-N 4105	Mask: 0010h	Bit
		5123	Busbar monitoring latched, Marine version only	Mask: 0008h	Bit
		5117	Plausibility GCB feedback latched, Marine version only	Mask: 0004h	Bit
		5111	Reactive load sharing mismatch latched, Marine version only	Mask: 0002h	Bit
		5105	Active load sharing mismatch latched, Marine version only	Mask: 0001h	Bit
6	3, 4		Alarms latched (unacknowledged)		
		5183	Free alarm 4	Mask: 2000h	Bit
		5177	Free alarm 3	Mask: 1000h	Bit
		5171	Free alarm 2	Mask: 0800h	Bit
		5165	Free alarm 1	Mask: 0400h	Bit
		5159	Max. starts per time	Mask: 0200h	Bit
		5153	Neutral contactor failure	Mask: 0100h	Bit
		5147	Decoupling GCB↔MCB	Mask: 0080h	Bit
		5141	Meas.difference 4105 VDE-AR-N 4105	Mask: 0040h	Bit
		5135	Parameter alignment VDE-AR-N 4105	Mask: 0020h	Bit
		5129	Missing member VDE-AR-N 4105	Mask: 0010h	Bit
		5123	Busbar monitoring latched, Marine version only	Mask: 0008h	Bit
		5117	Plausibility GCB feedback latched, Marine version only	Mask: 0004h	Bit
		5111	Reactive load sharing mismatch latched, Marine version only	Mask: 0002h	Bit
		5105	Active load sharing mismatch latched, Marine version only	Mask: 0001h	Bit
6	5,6		reserved		
<b>Flexible Thresholds</b>					

## Appendix

Data Protocols > CANopen > Protocol 5011 (Alarm Value...

CAN		Parameter ID	Description	Multiplier	Units
Data byte 0 (Mux)	Data byte				
7	1,2	-	Alarms Flexible thresholds 1-16 active		
		10033	Alarm flexible limit 16	Mask: 8000h	Bit
		10032	Alarm flexible limit 15	Mask: 4000h	Bit
		10031	Alarm flexible limit 14	Mask: 2000h	Bit
		10030	Alarm flexible limit 13	Mask: 1000h	Bit
		10029	Alarm flexible limit 12	Mask: 0800h	Bit
		10028	Alarm flexible limit 11	Mask: 0400h	Bit
		10027	Alarm flexible limit 10	Mask: 0200h	Bit
		10026	Alarm flexible limit 9	Mask: 0100h	Bit
		10025	Alarm flexible limit 8	Mask: 0080h	Bit
		10024	Alarm flexible limit 7	Mask: 0040h	Bit
		10023	Alarm flexible limit 6	Mask: 0020h	Bit
		10022	Alarm flexible limit 5	Mask: 0010h	Bit
		10021	Alarm flexible limit 4	Mask: 0008h	Bit
		10020	Alarm flexible limit 3	Mask: 0004h	Bit
		10019	Alarm flexible limit 2	Mask: 0002h	Bit
		10018	Alarm flexible limit 1	Mask: 0001h	Bit
7	3,4	-	Alarms Flexible thresholds 1-16 latched (unacknowledged)		
		10033	Alarm flexible limit 16	Mask: 8000h	Bit
		10032	Alarm flexible limit 15	Mask: 4000h	Bit
		10031	Alarm flexible limit 14	Mask: 2000h	Bit
		10030	Alarm flexible limit 13	Mask: 1000h	Bit
		10029	Alarm flexible limit 12	Mask: 0800h	Bit
		10028	Alarm flexible limit 11	Mask: 0400h	Bit
		10027	Alarm flexible limit 10	Mask: 0200h	Bit
		10026	Alarm flexible limit 9	Mask: 0100h	Bit
		10025	Alarm flexible limit 8	Mask: 0080h	Bit
		10024	Alarm flexible limit 7	Mask: 0040h	Bit
		10023	Alarm flexible limit 6	Mask: 0020h	Bit
		10022	Alarm flexible limit 5	Mask: 0010h	Bit
		10021	Alarm flexible limit 4	Mask: 0008h	Bit
		10020	Alarm flexible limit 3	Mask: 0004h	Bit
		10019	Alarm flexible limit 2	Mask: 0002h	Bit
		10018	Alarm flexible limit 1	Mask: 0001h	Bit
7	5,6		reserved		



CAN		Parameter ID	Description	Multiplier	Units
Data byte 0 (Mux)	Data byte				
8	1,2	-	Alarms Flexible thresholds 17-32 active		
		10049	Alarm flexible limit 32	Mask: 8000h	Bit
		10048	Alarm flexible limit 31	Mask: 4000h	Bit
		10047	Alarm flexible limit 30	Mask: 2000h	Bit
		10046	Alarm flexible limit 29	Mask: 1000h	Bit
		10045	Alarm flexible limit 28	Mask: 0800h	Bit
		10044	Alarm flexible limit 27	Mask: 0400h	Bit
		10043	Alarm flexible limit 26	Mask: 0200h	Bit
		10042	Alarm flexible limit 25	Mask: 0100h	Bit
		10041	Alarm flexible limit 24	Mask: 0080h	Bit
		10040	Alarm flexible limit 23	Mask: 0040h	Bit
		10039	Alarm flexible limit 22	Mask: 0020h	Bit
		10038	Alarm flexible limit 21	Mask: 0010h	Bit
		10037	Alarm flexible limit 20	Mask: 0008h	Bit
		10036	Alarm flexible limit 19	Mask: 0004h	Bit
		10035	Alarm flexible limit 18	Mask: 0002h	Bit
		10034	Alarm flexible limit 17	Mask: 0001h	Bit
8	3,4	-	Alarms Flexible thresholds 17-32 latched (unacknowledged)		
		10049	Alarm flexible limit 32	Mask: 8000h	Bit
		10048	Alarm flexible limit 31	Mask: 4000h	Bit
		10047	Alarm flexible limit 30	Mask: 2000h	Bit
		10046	Alarm flexible limit 29	Mask: 1000h	Bit
		10045	Alarm flexible limit 28	Mask: 0800h	Bit
		10044	Alarm flexible limit 27	Mask: 0400h	Bit
		10043	Alarm flexible limit 26	Mask: 0200h	Bit
		10042	Alarm flexible limit 25	Mask: 0100h	Bit
		10041	Alarm flexible limit 24	Mask: 0080h	Bit
		10040	Alarm flexible limit 23	Mask: 0040h	Bit
		10039	Alarm flexible limit 22	Mask: 0020h	Bit
		10038	Alarm flexible limit 21	Mask: 0010h	Bit
		10037	Alarm flexible limit 20	Mask: 0008h	Bit
		10036	Alarm flexible limit 19	Mask: 0004h	Bit
		10035	Alarm flexible limit 18	Mask: 0002h	Bit
		10034	Alarm flexible limit 17	Mask: 0001h	Bit
8	5,6		reserved		

## Appendix

Data Protocols > CANopen > Protocol 5011 (Alarm Value...

CAN		Parameter ID	Description	Multiplier	Units
Data byte 0 (Mux)	Data byte				
9	1,2		Alarms Flexible thresholds 33-40 active		
			internal	Mask: 8000h	Bit
			internal	Mask: 4000h	Bit
			internal	Mask: 2000h	Bit
			internal	Mask: 1000h	Bit
			internal	Mask: 0800h	Bit
			internal	Mask: 0400h	Bit
			internal	Mask: 0200h	Bit
			internal	Mask: 0100h	Bit
		10057	Alarm flexible limit 40	Mask: 0080h	Bit
		10056	Alarm flexible limit 39	Mask: 0040h	Bit
		10055	Alarm flexible limit 38	Mask: 0020h	Bit
		10054	Alarm flexible limit 37	Mask: 0010h	Bit
		10053	Alarm flexible limit 36	Mask: 0008h	Bit
		10052	Alarm flexible limit 35	Mask: 0004h	Bit
		10051	Alarm flexible limit 34	Mask: 0002h	Bit
		10050	Alarm flexible limit 33	Mask: 0001h	Bit
9	3,4		Alarms Flexible thresholds 33-40 latched (unacknowledged)		
			internal	Mask: 8000h	Bit
			internal	Mask: 4000h	Bit
			internal	Mask: 2000h	Bit
			internal	Mask: 1000h	Bit
			internal	Mask: 0800h	Bit
			internal	Mask: 0400h	Bit
			internal	Mask: 0200h	Bit
			internal	Mask: 0100h	Bit
		10057	Alarm flexible limit 40	Mask: 0080h	Bit
		10056	Alarm flexible limit 39	Mask: 0040h	Bit
		10055	Alarm flexible limit 38	Mask: 0020h	Bit
		10054	Alarm flexible limit 37	Mask: 0010h	Bit
		10053	Alarm flexible limit 36	Mask: 0008h	Bit
		10052	Alarm flexible limit 35	Mask: 0004h	Bit
		10051	Alarm flexible limit 34	Mask: 0002h	Bit
		10050	Alarm flexible limit 33	Mask: 0001h	Bit
9	5,6		0 (reserve)		

CAN		Parameter ID	Description	Multiplier	Units
Data byte 0 (Mux)	Data byte				
10	1,2		internal		
			internal	Mask: 8000h	Bit
			internal	Mask: 4000h	Bit
			internal	Mask: 2000h	Bit
			internal	Mask: 1000h	Bit
			internal	Mask: 0800h	Bit
			internal	Mask: 0400h	Bit
			internal	Mask: 0200h	Bit
			internal	Mask: 0100h	Bit
			internal	Mask: 0080h	Bit
			internal	Mask: 0040h	Bit
			internal	Mask: 0020h	Bit
			internal	Mask: 0010h	Bit
			internal	Mask: 0008h	Bit
			internal	Mask: 0004h	Bit
			internal	Mask: 0002h	Bit
			internal	Mask: 0001h	Bit
10	3,4		internal		
			internal	Mask: 8000h	Bit
			internal	Mask: 4000h	Bit
			internal	Mask: 2000h	Bit
			internal	Mask: 1000h	Bit
			internal	Mask: 0800h	Bit
			internal	Mask: 0400h	Bit
			internal	Mask: 0200h	Bit
			internal	Mask: 0100h	Bit
			internal	Mask: 0080h	Bit
			internal	Mask: 0040h	Bit
			internal	Mask: 0020h	Bit
			internal	Mask: 0010h	Bit
			internal	Mask: 0008h	Bit
			internal	Mask: 0004h	Bit
			internal	Mask: 0002h	Bit
			internal	Mask: 0001h	Bit
10	5,6		reserved		

## Appendix

Data Protocols > CANopen > Protocol 5011 (Alarm Value...

CAN		Parameter ID	Description	Multiplier	Units
Data byte 0 (Mux)	Data byte				
<b>Internal DC Analogue Values Wirebreak</b>					
11	1,2	-	Alarms Analog Inputs 1 active		
			internal	Mask: 8000h	Bit
			internal	Mask: 4000h	Bit
			internal	Mask: 2000h	Bit
			internal	Mask: 1000h	Bit
			internal	Mask: 0800h	Bit
			internal	Mask: 0400h	Bit
			internal	Mask: 0200h	Bit
			internal	Mask: 0100h	Bit
			internal	Mask: 0080h	Bit
			internal	Mask: 0040h	Bit
			internal	Mask: 0020h	Bit
			internal	Mask: 0010h	Bit
		1008	Batt. overvolt.2	Mask: 0008h	Bit
		1007	Batt. undervolt.2	Mask: 0004h	Bit
		1006	Batt. overvolt. 1	Mask: 0002h	Bit
		1005	Batt. undervolt. 1	Mask: 0001h	Bit
11	3,4	10136	Alarms Analog Inputs 1 latched (unacknowledged)		
			internal	Mask: 8000h	Bit
			internal	Mask: 4000h	Bit
			internal	Mask: 2000h	Bit
			internal	Mask: 1000h	Bit
			internal	Mask: 0800h	Bit
			internal	Mask: 0400h	Bit
			internal	Mask: 0200h	Bit
			internal	Mask: 0100h	Bit
			internal	Mask: 0080h	Bit
			internal	Mask: 0040h	Bit
			internal	Mask: 0020h	Bit
			internal	Mask: 0010h	Bit
		1008	Batt. overvolt.2	Mask: 0008h	Bit
		1007	Batt. undervolt.2	Mask: 0004h	Bit
		1006	Batt. overvolt. 1	Mask: 0002h	Bit
		1005	Batt. undervolt. 1	Mask: 0001h	Bit

CAN		Parameter ID	Description	Multiplier	Units
Data byte 0 (Mux)	Data byte				
11	5,6		reserved		
12	1,2	10137	Alarms Analog Inputs Wire Break active		
			internal	Mask: 0001h	Bit
		10014	Analog inp. 1, wire break	Mask: 0002h	Bit
		10015	Analog inp. 2, wire break	Mask: 0004h	Bit
		10060	Analog inp. 3, wire break	Mask: 0008h	Bit
		10061	internal	Mask: 0010h	Bit
		10062	internal	Mask: 0020h	Bit
		10063	internal	Mask: 0040h	Bit
		10064	internal	Mask: 0080h	Bit
		10065	internal	Mask: 0100h	Bit
		10066	internal	Mask: 0200h	Bit
		10067	internal	Mask: 0400h	Bit
			internal	Mask: 0800h	Bit
			internal	Mask: 1000h	Bit
			internal	Mask: 2000h	Bit
			internal	Mask: 4000h	Bit
			internal	Mask: 8000h	Bit
12	3, 4	10137	Alarms Analog Inputs Wire Break latched (unacknowledged)		
			internal	Mask: 0001h	Bit
		10014	Analog inp. 1, wire break	Mask: 0002h	Bit
		10015	Analog inp. 2, wire break	Mask: 0004h	Bit
		10060	Analog inp. 3, wire break	Mask: 0008h	Bit
		10061	internal	Mask: 0010h	Bit
		10062	internal	Mask: 0020h	Bit
		10063	internal	Mask: 0040h	Bit
		10064	internal	Mask: 0080h	Bit
		10065	internal	Mask: 0100h	Bit
		10066	internal	Mask: 0200h	Bit
		10067	internal	Mask: 0400h	Bit
			internal	Mask: 0800h	Bit
			internal	Mask: 1000h	Bit
			internal	Mask: 2000h	Bit
			internal	Mask: 4000h	Bit
			internal	Mask: 8000h	Bit

## Appendix

Data Protocols > CANopen > Protocol 5011 (Alarm Value...

CAN		Parameter ID	Description	Multiplier	Units
Data byte 0 (Mux)	Data byte				
12	5, 6		reserved		
<b>Internal Digital Inputs</b>					
13	1,2	-	Alarms Digital Inputs 1 active		
		10600	Digital Input 1	Mask: 8000h	Bit
		10601	Digital Input 2	Mask: 4000h	Bit
		10602	Digital Input 3	Mask: 2000h	Bit
		10603	Digital Input 4	Mask: 1000h	Bit
		10604	Digital Input 5	Mask: 0800h	Bit
		10605	Digital Input 6	Mask: 0400h	Bit
		10607	Digital Input 7	Mask: 0200h	Bit
		10608	Digital Input 8 (reply GCB)	Mask: 0100h	Bit
		10609	Digital Input 9	Mask: 0080h	Bit
		10610	Digital Input 10	Mask: 0040h	Bit
		10611	Digital Input 11	Mask: 0020h	Bit
		10612	Digital Input 12	Mask: 0010h	Bit
			internal	Mask: 0008h	Bit
			internal	Mask: 0004h	Bit
			internal	Mask: 0002h	Bit
			internal	Mask: 0001h	Bit
13	3,4	10132	Alarms Digital Inputs 1 latched (unacknowledged)		
		10600	Digital Input 1	Mask: 8000h	Bit
		10601	Digital Input 2	Mask: 4000h	Bit
		10602	Digital Input 3	Mask: 2000h	Bit
		10603	Digital Input 4	Mask: 1000h	Bit
		10604	Digital Input 5	Mask: 0800h	Bit
		10605	Digital Input 6	Mask: 0400h	Bit
		10607	Digital Input 7	Mask: 0200h	Bit
		10608	Digital Input 8 (reply GCB)	Mask: 0100h	Bit
		10609	Digital Input 9	Mask: 0080h	Bit
		10610	Digital Input 10	Mask: 0040h	Bit
		10611	Digital Input 11	Mask: 0020h	Bit
		10612	Digital Input 12	Mask: 0010h	Bit
			internal	Mask: 0008h	Bit
			internal	Mask: 0004h	Bit
			internal	Mask: 0002h	Bit

CAN		Parameter ID	Description	Multiplier	Units
Data byte 0 (Mux)	Data byte				
			internal	Mask: 0001h	Bit
13	5,6	10131	Alarm classes latched (unacknowledged)		
			internal	Mask: 8000h	Bit
			internal	Mask: 4000h	Bit
			internal	Mask: 2000h	Bit
			internal	Mask: 1000h	Bit
			internal	Mask: 0800h	Bit
			internal	Mask: 0400h	Bit
			internal	Mask: 0200h	Bit
			internal	Mask: 0100h	Bit
			internal	Mask: 0080h	Bit
			internal	Mask: 0040h	Bit
			Class F	Mask: 0020h	Bit
			Class E	Mask: 0010h	Bit
			Class D	Mask: 0008h	Bit
			Class C	Mask: 0004h	Bit
			Class B	Mask: 0002h	Bit
			Class A	Mask: 0001h	Bit
14	1,2	-	Alarms Digital Inputs 2 active		
		10613	internal	Mask: 8000h	Bit
		10614	internal	Mask: 4000h	Bit
		10615	internal	Mask: 2000h	Bit
		10616	internal	Mask: 1000h	Bit
		10617	internal	Mask: 0800h	Bit
		10618	internal	Mask: 0400h	Bit
		10619	internal	Mask: 0200h	Bit
		10620	internal	Mask: 0100h	Bit
		10621	internal	Mask: 0080h	Bit
		10622	internal	Mask: 0040h	Bit
		10623	internal	Mask: 0020h	Bit
			internal	Mask: 0010h	Bit
			internal	Mask: 0008h	Bit
			internal	Mask: 0004h	Bit
			internal	Mask: 0002h	Bit
			internal	Mask: 0001h	Bit

## Appendix









Data Protocols > CANopen > Protocol 5011 (Alarm Value...

CAN		Parameter ID	Description	Multiplier	Units
Data byte 0 (Mux)	Data byte				
14	3,4	-	Alarms Digital Inputs 2 latched (unacknowledged)		
		10613	internal	Mask: 8000h	Bit
		10614	internal	Mask: 4000h	Bit
		10615	internal	Mask: 2000h	Bit
		10616	internal	Mask: 1000h	Bit
		10617	internal	Mask: 0800h	Bit
		10618	internal	Mask: 0400h	Bit
		10619	internal	Mask: 0200h	Bit
		10620	internal	Mask: 0100h	Bit
		10621	internal	Mask: 0080h	Bit
		10622	internal	Mask: 0040h	Bit
		10623	internal	Mask: 0020h	Bit
			internal	Mask: 0010h	Bit
			internal	Mask: 0008h	Bit
			internal	Mask: 0004h	Bit
			internal	Mask: 0002h	Bit
			internal	Mask: 0001h	Bit
14	5,6		reserved		
<b>External Digital Inputs</b>					
15	1,2	-	Alarms External Digital Inputs active		
		16376	External Digital Input 16	Mask: 8000h	Bit
		16375	External Digital Input 15	Mask: 4000h	Bit
		16374	External Digital Input 14	Mask: 2000h	Bit
		16373	External Digital Input 13	Mask: 1000h	Bit
		16372	External Digital Input 12	Mask: 0800h	Bit
		16371	External Digital Input 11	Mask: 0400h	Bit
		16370	External Digital Input 10	Mask: 0200h	Bit
		16369	External Digital Input 9	Mask: 0100h	Bit
		16368	External Digital Input 8	Mask: 0080h	Bit
		16367	External Digital Input 7	Mask: 0040h	Bit
		16366	External Digital Input 6	Mask: 0020h	Bit
		16365	External Digital Input 5	Mask: 0010h	Bit
		16364	External Digital Input 4	Mask: 0008h	Bit
		16362	External Digital Input 3	Mask: 0004h	Bit
		16361	External Digital Input 2	Mask: 0002h	Bit



CAN		Parameter ID	Description	Multiplier	Units
Data byte 0 (Mux)	Data byte				
		16360	External Digital Input 1	Mask: 0001h	Bit
15	3,4	16377	Alarms External Digital Inputs latched (unacknowledged)		
		16376	External Digital Input 16	Mask: 8000h	Bit
		16375	External Digital Input 15	Mask: 4000h	Bit
		16374	External Digital Input 14	Mask: 2000h	Bit
		16373	External Digital Input 13	Mask: 1000h	Bit
		16372	External Digital Input 12	Mask: 0800h	Bit
		16371	External Digital Input 11	Mask: 0400h	Bit
		16370	External Digital Input 10	Mask: 0200h	Bit
		16369	External Digital Input 9	Mask: 0100h	Bit
		16368	External Digital Input 8	Mask: 0080h	Bit
		16367	External Digital Input 7	Mask: 0040h	Bit
		16366	External Digital Input 6	Mask: 0020h	Bit
		16365	External Digital Input 5	Mask: 0010h	Bit
		16364	External Digital Input 4	Mask: 0008h	Bit
		16362	External Digital Input 3	Mask: 0004h	Bit
		16361	External Digital Input 2	Mask: 0002h	Bit
		16360	External Digital Input 1	Mask: 0001h	Bit
15	5,6		reserved		
16	1,2	-	Alarm External Digital Inputs 1 active		
		16352	 P2 only: External Digital Input 32	Mask: 8000h	Bit
		16342	 P2 only: External Digital Input 31	Mask: 4000h	Bit
		16332	 P2 only: External Digital Input 30	Mask: 2000h	Bit
		16322	 P2 only: External Digital Input 29	Mask: 1000h	Bit
		16312	 P2 only: External Digital Input 28	Mask: 0800h	Bit
		16302	 P2 only: External Digital Input 27	Mask: 0400h	Bit
		16292	 P2 only: External Digital Input 26	Mask: 0200h	Bit
		16282	 P2 only: External Digital Input 25	Mask: 0100h	Bit
		16272	 P2 only: External Digital Input 34	Mask: 0080h	Bit
		16262	 P2 only: External Digital Input 23	Mask: 0040h	Bit
		16252	 P2 only: External Digital Input 22	Mask: 0020h	Bit
		16242	 P2 only: External Digital Input 21	Mask: 0010h	Bit
		16232	 P2 only: External Digital Input 20	Mask: 0008h	Bit
		16222	 P2 only: External Digital Input 19	Mask: 0004h	Bit

CAN		Parameter ID	Description	Multiplier	Units
Data byte 0 (Mux)	Data byte				
		16212	only: External Digital Input 18	Mask: 0002h	Bit
		16202	only: External Digital Input 17	Mask: 0001h	Bit
16	3,4	-	Alarm External Digital Inputs 1 latched (unacknowledged)		
		16352	only: External Digital Input 32	Mask: 8000h	Bit
		16342	only: External Digital Input 31	Mask: 4000h	Bit
		16332	only: External Digital Input 30	Mask: 2000h	Bit
		16322	only: External Digital Input 29	Mask: 1000h	Bit
		16312	only: External Digital Input 28	Mask: 0800h	Bit
		16302	only: External Digital Input 27	Mask: 0400h	Bit
		16292	only: External Digital Input 26	Mask: 0200h	Bit
		16282	only: External Digital Input 25	Mask: 0100h	Bit
		16272	only: External Digital Input 24	Mask: 0080h	Bit
		16262	only: External Digital Input 23	Mask: 0040h	Bit
		16252	only: External Digital Input 22	Mask: 0020h	Bit
		16242	only: External Digital Input 21	Mask: 0010h	Bit
		16232	only: External Digital Input 20	Mask: 0008h	Bit
		16222	only: External Digital Input 19	Mask: 0004h	Bit
		16212	only: External Digital Input 18	Mask: 0002h	Bit
		16202	only: External Digital Input 17	Mask: 0001h	Bit
16	5,6		reserved		
<b>External DC Analogue Values Wirebreak</b>					
17	1,2	-	Alarms External Analog Inputs Wire Break active		
		10221	only: Ext. Analog Inp. 01, wire break	Mask: 0001h	Bit
		10222	only: Ext. Analog Inp. 02, wire break	Mask: 0002h	Bit
		10223	only: Ext. Analog Inp. 03, wire break	Mask: 0004h	Bit
		10224	only: Ext. Analog Inp. 04, wire break	Mask: 0008h	Bit
		10225	only: Ext. Analog Inp. 05, wire break	Mask: 0010h	Bit
		10226	only: Ext. Analog Inp. 06, wire break	Mask: 0020h	Bit
		10227	only: Ext. Analog Inp. 07, wire break	Mask: 0040h	Bit
		10228	only: Ext. Analog Inp. 08, wire break	Mask: 0080h	Bit
		10229	only: Ext. Analog Inp. 09, wire break	Mask: 0100h	Bit
		10230	only: Ext. Analog Inp. 10, wire break	Mask: 0200h	Bit

CAN		Parameter ID	Description	Multiplier	Units
Data byte 0 (Mux)	Data byte				
		10231	 only: Ext. Analog Inp. 11, wire break	Mask: 0400h	Bit
		10232	 only: Ext. Analog Inp. 12, wire break	Mask: 0800h	Bit
		10233	 only: Ext. Analog Inp. 13, wire break	Mask: 1000h	Bit
		10234	 only: Ext. Analog Inp. 14, wire break	Mask: 2000h	Bit
		10235	 only: Ext. Analog Inp. 15, wire break	Mask: 4000h	Bit
		10236	 only: Ext. Analog Inp. 16, wire break	Mask: 8000h	Bit
17	3,4	-	Alarms External Analog Inputs Wire Break latched (unacknowledged)		
		10221	 only: Ext. Analog Inp. 01, wire break	Mask: 0001h	Bit
		10222	 only: Ext. Analog Inp. 02, wire break	Mask: 0002h	Bit
		10223	 only: Ext. Analog Inp. 03, wire break	Mask: 0004h	Bit
		10224	 only: Ext. Analog Inp. 04, wire break	Mask: 0008h	Bit
		10225	 only: Ext. Analog Inp. 05, wire break	Mask: 0010h	Bit
		10226	 only: Ext. Analog Inp. 06, wire break	Mask: 0020h	Bit
		10227	 only: Ext. Analog Inp. 07, wire break	Mask: 0040h	Bit
		10228	 only: Ext. Analog Inp. 08, wire break	Mask: 0080h	Bit
		10229	 only: Ext. Analog Inp. 09, wire break	Mask: 0100h	Bit
		10230	 only: Ext. Analog Inp. 10, wire break	Mask: 0200h	Bit
		10231	 only: Ext. Analog Inp. 11, wire break	Mask: 0400h	Bit
		10232	 only: Ext. Analog Inp. 12, wire break	Mask: 0800h	Bit
		10233	 only: Ext. Analog Inp. 13, wire break	Mask: 1000h	Bit
		10234	 only: Ext. Analog Inp. 14, wire break	Mask: 2000h	Bit
		10235	 only: Ext. Analog Inp. 15, wire break	Mask: 4000h	Bit
		10236	 only: Ext. Analog Inp. 16, wire break	Mask: 8000h	Bit
17	5,6		reserved		

### 9.2.2.8 Protocol 6000 (Load Share Message)

#### General information

The load share message contains all data, which is required for load/var sharing, load-dependent start/stop and dead bus detection.

Further data, which is exchanged between the control units concerns time synchronization and parameter alignment. Parameter alignment is intended for those parameters, which must be configured identically for all units participating in load sharing, to ensure a proper operation of load sharing or load-dependent start/stop.

In order to lower the bus load, the messages are divided into "fast", "normal", and "slow" refreshed data. The mux is identified accordingly with "F", "N", and "S" (refer to the following tables). The load share message contains one fast, two normal, and four slow messages, which are made up as in [“Load share bus communication” on page 621](#).

**Timing**

The time interval between two fast messages (T<sub>Fast</sub>, i.e. the time for refreshing a fast message) is configured with the parameter "Transfer rate LS fast message" (parameter 9921 [p. 369](#)). The time intervals between refreshing a normal or slow messages depend on this parameter as well according to the following sequence:

- S0 – F – N0 – F – N1 – F – S1 – F – N0 – F – N1 – F – S2 – F – N0 – F – N1 – F – S3 – F – N0 – F – N1 – F
- T<sub>Fast</sub> = time interval between refreshing the fast message
- T<sub>Normal</sub> = time interval between refreshing a normal message = 3 x T<sub>Fast</sub>
- T<sub>Slow</sub> = time interval between refreshing a slow message = 12 x T<sub>Fast</sub>

**Example**

- The parameter "Transfer rate LS fast message" (parameter 9921 [p. 369](#)) is configured to "0.10 s".
- The sequence of the sent messages for T<sub>Fast</sub> = 100 ms (i.e. 0.10 s) is shown in [“Load share bus communication” on page 621](#).
- This means that a new message is sent every 50 ms.

Time [ms]	0	50	100	150	200	250	300	350	400	450	500	550
Sent message	S0	F	N0	F	N1	F	S1	F	N0	F	N1	F
MUX #	0	3	1	3	2	3	4	3	1	3	2	3

Time [ms]	600	650	700	750	800	850	900	950	1000	1050	1100	1150
Sent message	S2	F	N0	F	N1	F	S3	F	N0	F	N1	F
MUX #	5	3	1	3	2	3	6	3	1	3	2	3

The maximum length of the CAN bus load share line depends on "Transfer rate LS fast message" (parameter 9921 [p. 369](#)).

The values in [“Load share line - max. length \(32 participants\)” on page 621](#) are valid for 32 participants and a bus load of approx. 40 %.

TFast [ms]	TNormal [ms]	TSlow [ms]	Baud rate	Distance
100	300	1200	250 kBaud	250 m
200	600	2400	125 kBaud	500 m
300	900	3800	50 kBaud	1000 m

Table 97: Load share line - max. length (32 participants)

## Load share bus communication

Load share bus communication - "fast" refreshed data					
MUX	Byte	Bit	Function	Remark	
F	0		3	MUX identifier	
	1		Generator real load capacity utilization rate, L-Byte	Integer [%], signed	
	2		Generator real load capacity utilization rate, H-Byte		
	3		Generator reactive load capacity utilization rate, L-Byte	Integer [%], signed	
	4		Generator reactive load capacity utilization rate, H-Byte		
	5	0		Active power load sharing is enabled	
		1		Reactive power load sharing is enabled	
		2		GCB is closed	
		3		MCB is closed	
		4		Reserved	
		5		Dead bus closure request is active	Dead bus detection
		6		Mains settling time is running	Back synchronization to mains
		7		Shutdown alarm is active (alarm class C,D,E,F)	
	6	0-4		Bus segment / node	Max. 32 nodes possible
		5		Not used	
		6		LDSS: add-on request enabled	Load dependent start / stop
		7		LDSS: add-off request enabled (reserved)	Load dependent start / stop
	7		Not used		

Load share bus communication - "normal" refreshed data				
MUX	Byte	Bit	Function	Remark
N0	0		1	MUX identifier
	1		Generator real load, L-Byte, L-Word	Long [W]
	2		Generator real load, H-Byte, L-Word	
	3		Generator real load, L-Byte, H-Word	
	4		Generator real load, H-Byte, H-Word	

Load share bus communication - "normal" refreshed data					
MUX	Byte	Bit	Function	Remark	
	5	0-3	Real load control state	2: Static 3: Isochronous 4: Base load control 5: Export/import control 10: Load share 0, 1, 6, 7, 8, 9, 11, ... : internal	
		4-7	Reactive load control state	2: Static 3: Isochronous 4: Reactive load control 5: Import/export reactive load 10: Reactive load share 0, 1, 6, 7, 8, 9, 11, ... : internal	
	6	0-3	Engine state	1: Locked out 2: Off 3: Preglow 4: Crank 5: Run 6: Cool down 7: Spin down 8: Start pause 9: Idle 0, 10, 11, ... : internal	
			4,5	Operating mode	0: Not available 1: STOP 2: MANUAL 3: AUTOMATIC
			6	Generator request	Generator is in AUTOMATIC mode and able to produce rated active power
		7	Not used		
		7	0..4	Neutral Interlocking Priority	The value of the parameter 1841 ↗ p. 234 Priority
	Not used				
	6		Neutral interlocking - wish to close	The device will close the Neutral Contactor (NC) switch. If the NC switch is closed the wish goes away.	
	7		Neutral interlocking is closed	The NC and the GCB switches are closed	

Load share bus communication - "normal" refreshed data					
MUX	Byte	Bit	Function	Remark	
N1	0		2	MUX identifier	
	1		Generator reactive load, L-Byte, L-Word	Long [var]	
	2		Generator reactive load, H-Byte, L-Word		
	3		Generator reactive load, L-Byte, H-Word		
	4		Generator reactive load, H-Byte, H-Word		
	5	0		Generator voltage and frequency ok	
				Busbar voltage and frequency ok	
				Mains voltage and frequency ok	
				Fourth system voltage and frequency ok	
				Not used	
				Not used	
				Not used	
				Not used	
	6	0		Command 1 to CB control	
				Command 2 to CB control	
				Command 3 to CB control	
				Command 4 to CB control	
				Command 5 to CB control	
				Command 6 to CB control	
				Not used	
7		Not used			

Load share bus communication - "slow" refreshed data				
MUX	Byte	Bit	Function	Remark
S0	0		0	MUX identifier
	1		Protocol-Identifier	
	2			
	3		Generator rated real power, L-Byte, L-Word	Long [0.1 kW]
	4		Generator rated real power, H-Byte, L-Word	
	5		Generator rated real power, L-Byte, H-Word	
	6		Generator rated real power, H-Byte, H-Word	
	7		Not used	
S1	0		4	MUX identifier
	1		Generator rated reactive power, L-Byte, L-Word	Long [0.1 kvar]

Load share bus communication - "slow" refreshed data					
MUX	Byte	Bit	Function	Remark	
	2		Generator rated reactive power, H-Byte, L-Word		
	3		Generator rated reactive power, L-Byte, H-Word		
	4		Generator rated reactive power, H-Byte, H-Word		
	5		0-4	Base segment	Max. number of nodes: 32 / 64 with bit 5
			5	Extended bit for Base segment	
			6-7	Not used	
	6		0-4	Priority	Up to 32
5-7			Not used		
7		Not used			
S2	0		5	MUX identifier	
	1		Operating hours L-Byte, L-Word	Long [h]	
	2		Operating hours H-Byte, L-Word		
	3		Operating hours L-Byte, H-Word		
	4		Operating hours H-Byte, H-Word		
	5		0	Alarm class A occurred	
			1	Alarm class B occurred	
			2	Alarm class C occurred	
			3	Alarm class D occurred	
			4	Alarm class E occurred	
			5	Alarm class F occurred	
			6	Warning alarm class occurred	
	7	Not used			
6		LSI connection	Load share interface		
7		Not used			
S3	0		6	MUX identifier	
	1		Remaining days before maintenance, L-Byte	Integer [d]	
	2		Remaining days before maintenance, H-Byte		
	3		Remaining operating hours before maintenance, L-Byte	Integer [h]	
	4		Remaining operating hours before maintenance, H-Byte		
	5		Checksum parameters L-Byte	Load share and load-dependent start / stop parameters	
	6		Checksum parameters H-Byte		
	7		Not used		



## 9.2.2.9 Protocol 65000 (External Discrete I/O 1 to 8)



*If this data protocol is addressed to an expansion board, it is used to issue a command to energize a discrete output of the expansion board (parameter 8005 is written).*

*If this data protocol is addressed to an easYgen, it is used to transmit the state of a discrete input of an expansion board (parameter 8014 is written).*

CAN		Parameter ID	Description	Multiplier	Units
Data byte 0 (Mux)	Data byte				
1	1	-	Discrete Inputs/Outputs 1 to 8		--
			0: Discrete I/O 1		Bit
			1: Discrete I/O 2		Bit
			2: Discrete I/O 3		Bit
			3: Discrete I/O 4		Bit
			4: Discrete I/O 5		Bit
			5: Discrete I/O 6		Bit
			6: Discrete I/O 7		Bit
			7: Discrete I/O 8		Bit
	2	-	internal		
	3,4,5,6	-	internal		

## 9.2.2.10 Protocol 65001 (External Discrete I/O 9 to 16)



*If this data protocol is addressed to an expansion board, it is used to issue a command to energize a discrete output of the expansion board (parameter 8005 is written).*

*If this data protocol is addressed to an easYgen, it is used to transmit the state of a discrete input of an expansion board (parameter 8014 is written).*

CAN		Parameter ID	Description	Multiplier	Units
Data byte 0 (Mux)	Data byte				
1	1	-	Discrete Inputs/Outputs 9 to 16		--
			0: Discrete I/O 9		Bit
			1: Discrete I/O 10		Bit

CAN		Parameter ID	Description	Multiplier	Units
Data byte 0 (Mux)	Data byte				
			2: Discrete I/O 11		Bit
			3: Discrete I/O 12		Bit
			4: Discrete I/O 13		Bit
			5: Discrete I/O 14		Bit
			6: Discrete I/O 15		Bit
			7: Discrete I/O 16		Bit
	2	-	internal		
	3,4,5,6	-	internal		

### 9.2.3 Modbus

#### 9.2.3.1 Protocol 5010 (Basic Visualization)



**P2** only: ... " applies to easYgen-3100/3200 Package P2 only.

Modbus		Parameter ID	Description	Multiplier	Units
Modicon start addr.	Start addr. (*1)				
450001	450000		Protocol-ID, always 5010		-
450002	450001	3181	Scaling Power (16 bits) Exponent 10x W (5;4;3;2)		
450003	450002	3182	Scaling Volts (16 bits) Exponent 10x V (2;1;0;-1)		
450004	450003	3183	Scaling Amps (16 bits) Exponent 10x A (0;-1)		
450005	450004		reserved		
450006	450005		reserved		
450007	450006		reserved		
450008	450007		reserved		
450009	450008		reserved		
<b>AC Generator And Busbar Values</b>					
450010	450009	144	Generator frequency	0.01	Hz
450011	450010	246	Total generator power	scaled defined by index 3181 (modicon Address 450002)	W

Modbus		Parameter ID	Description	Multiplier	Units
Modicon start addr.	Start addr. (*1)				
450012	450011	247	Total generator reactive power	scaled defined by index 3181 (modicon Address 450002)	var
450013	450012	160	Generator power factor	0.001	
450014	450013	248	Generator voltage L1-L2	scaled defined by index 3182 (modicon Address 450003)	V
450015	450014	249	Generator voltage L2-L3	scaled defined by index 3182 (modicon Address 450003)	V
450016	450015	250	Generator voltage L3-L1	scaled defined by index 3182 (modicon Address 450003)	V
450017	450016	251	Generator voltage L1-N	scaled defined by index 3182 (modicon Address 450003)	V
450018	450017	252	Generator voltage L2-N	scaled defined by index 3182 (modicon Address 450003)	V
450019	450018	253	Generator voltage L3-N	scaled defined by index 3182 (modicon Address 450003)	V
450020	450019	255	Generator current 1	scaled defined by index 3183 (modicon Address 450004)	A
450021	450020	256	Generator current 2	scaled defined by index 3183 (modicon Address 450004)	A
450022	450021	257	Generator current 3	scaled defined by index 3183 (modicon Address 450004)	A
450023	450022	209	Busbar 1: Frequency	0.01	Hz
450024	450023	254	Busbar 1: voltage L1-L2	scaled defined by index 3182 (modicon Address 450003)	V
450025	450024		reserved		
450026	450025		reserved		
450027	450026		reserved		
450028	450027		reserved		
450029	450028	5541	Setpoint frequency	1	Hz
450030	450029	5641	Setpoint power factor (cosphi)	1	
<b>AC Mains Values</b>					
450031	450030	147	Mains frequency	0.01	Hz

## Appendix











Data Protocols > Modbus > Protocol 5010 (Basic Visua...





Modbus		Parameter ID	Description	Multiplier	Units
Modicon start addr.	Start addr. (*1)				
450032	450031	258	Total mains power	scaled defined by index 3181 (modicon Address 450002)	W
450033	450032	259	Total mains reactive power	scaled defined by index 3181 (modicon Address 450002)	var
450034	450033	208	Mains power factor	0.001	
450035	450034	260	Mains voltage L1-L2	scaled defined by index 3182 (modicon Address 450003)	V
450036	450035	261	Mains voltage L2-L3	scaled defined by index 3182 (modicon Address 450003)	V
450037	450036	262	Mains voltage L3-L1	scaled defined by index 3182 (modicon Address 450003)	V
450038	450037	263	Mains voltage L1-N	scaled defined by index 3182 (modicon Address 450003)	V
450039	450038	264	Mains voltage L2-N	scaled defined by index 3182 (modicon Address 450003)	V
450040	450039	265	Mains voltage L3-N	scaled defined by index 3182 (modicon Address 450003)	V
450041	450040	266	Mains current L1	scaled defined by index 3183 (modicon Address 450004)	A
450042	450041		reserved		
450043	450042		reserved		
450044	450043		reserved		
450045	450044		reserved		
<b>AC System Values</b>					
450046	450045	239	Nominal real power in system	0.01	% (Reference value parameter 1825 p. 96.)

Modbus		Parameter ID	Description	Multiplier	Units
Modicon start addr.	Start addr. (*1)				
450047	450046	240	Real power in system	0.01	% (Reference value parameter 1825 ↗ p. 96.)
450048	450047	241	Reserve real power in system	0.01	% (Reference value parameter 1825 ↗ p. 96.)
450049	450048		reserved		
450050	450049		reserved		
450051	450050		reserved		
<b>DC Analogue Values (Engine Values)</b>					
450052	450051	10100	Engine Pickup speed	1	rpm
450053	450052	10110	Battery voltage	0.1	V
450054	450053	10159	AI Auxiliary excitation D+	0.1	V
450055	450054	2540	Engine, number of start requests	1	
450056	450055	2558	Hours until next maintenance	1	h
450057	450056	10111	Analog input 1	changeable	
450058	450057	10112	Analog input 2	changeable	
450059	450058	10115	Analog input 3	changeable	
450060	450059	10117	Analog input 4	changeable	
450061	450060	10151	Analog input 5	changeable	
450062	450061	10152	Analog input 6	changeable	
450063	450062	10153	Analog input 7	changeable	
450064	450063	10154	Analog input 8	changeable	
450065	450064	10155	Analog input 9	changeable	
450066	450065	10156	Analog input 10	changeable	
450067	450066		reserved		
450068	450067		reserved		
450069	450068	10310	Analog output 1	0,01	%
450070	450069	10311	Analog output 2	0,01	%
450071	450070		reserved		

## Appendix

Data Protocols > Modbus > Protocol 5010 (Basic Visua...

Modbus		Parameter ID	Description	Multiplier	Units
Modicon start addr.	Start addr. (*1)				
450072	450071	10318	Analog output 4	0,01	%
450073	450072	10319	Analog output 5	0,01	%
450074	450073	10320	Analog output 6	0,01	%
450075	450074	10170	 P2 only: External Analog input 1	changeable	
450076	450075	10171	 P2 only: External Analog input 2	changeable	
450077	450076	10172	 P2 only: External Analog input 3	changeable	
450078	450077	10173	 P2 only: External Analog input 4	changeable	
450079	450078	10174	 P2 only: External Analog input 5	changeable	
450080	450079	10175	 P2 only: External Analog input 6	changeable	
450081	450080	10176	 P2 only: External Analog input 7	changeable	
450082	450081	10177	 P2 only: External Analog input 8	changeable	
450083	450082	10178	 P2 only: External Analog input 9	changeable	
450084	450083	10179	 P2 only: External Analog input 10	changeable	
450085	450084	10180	 P2 only: External Analog input 11	changeable	
450086	450085	10181	 P2 only: External Analog input 12	changeable	
450087	450086	10182	 P2 only: External Analog input 13	changeable	
450088	450087	10183	 P2 only: External Analog input 14	changeable	
450089	450088	10184	 P2 only: External Analog input 15	changeable	
450090	450089	10185	 P2 only: External Analog input 16	changeable	
450091	450090	10245	 P2 only: External Analog Output 1	0,01	%
450092	450091	10255	 P2 only: External Analog Output 2	0,01	%
450093	450092	10265	 P2 only: External Analog Output 3	0,01	%
450094	450093	10275	 P2 only: External Analog Output 4	0,01	%
450095	450094	2556	Days until next maintenance	1	days
450096	450095		reserved		
450097	450096		reserved		
450098	450097		reserved		
450099	450098		reserved		
<b>Control And Status</b>					
450100	450099	1735	Control mode (STOP/AUTO/MANUAL)	Mask: 000Fh 1 = AUTO 2 = STOP 4 = MANUAL	(enum.)

Modbus		Parameter ID	Description	Multiplier	Units
Modicon start addr.	Start addr. (*1)				
450101	450100	10202	State Display	ID description refer to ↳ Chapter 9.5.3 "Status Messages" on page 735	(enum.)
450102	450101		reserved		
450103	450102	4153	ControlBits 1		
			Idle mode monitoring (suppresses under-volt,...)	Mask: 8000h	Bit
			Idle mode active	Mask: 4000h	Bit
			Start without closing GCB	Mask: 2000h	Bit
			internal	Mask: 1000h	Bit
			A manual START has been requested	Mask: 0800h	Bit
			A manual STOP has been requested	Mask: 0400h	Bit
			Cooldown is active	Mask: 0200h	Bit
			Auxiliary services generally active	Mask: 0100h	Bit
			Engine Monitoring delay timer has expired	Mask: 0080h	Bit
			Breaker delay timer has expired	Mask: 0040h	Bit
			Engine start is requested	Mask: 0020h	Bit
			Critical mode is active in automatic mode	Mask: 0010h	Bit
			Engine is released (speed governor is enabled)	Mask: 0008h	Bit
			Auxiliary services prerun is active	Mask: 0004h	Bit
			Auxiliary services postrun is active	Mask: 0002h	Bit
			internal activation of Lamp test	Mask: 0001h	Bit
450104	450103	4154	ControlBits 2		
			Crank (Starter) is active	Mask: 8000h	Bit
			Operating Magnet / Gasrelay is active	Mask: 4000h	Bit
			Preglow / Ignition is active	Mask: 2000h	Bit
			Mains settling timer is running	Mask: 1000h	Bit
			Emergency mode is currently active	Mask: 0800h	Bit
			internal	Mask: 0400h	Bit
			 only: Free PID Controller 3: Lower Command	Mask: 0200h	Bit
			 only: Free PID Controller 3: Raise Command	Mask: 0100h	Bit
			 only: Free PID Controller 2: Lower Command	Mask: 0080h	Bit
			 only: Free PID Controller 2: Raise Command	Mask: 0040h	Bit

## Appendix

Data Protocols > Modbus > Protocol 5010 (Basic Visua...









Modbus		Parameter ID	Description	Multiplier	Units
Modicon start addr.	Start addr. (*1)				
			Stopping Magnet is active	Mask: 0020h	Bit
			internal	Mask: 0010h	Bit
			The genset runs mains parallel	Mask: 0008h	Bit
			 only: Free PID Controller 1: Lower Command	Mask: 0004h	Bit
			 only: Free PID Controller 1: Raise Command	Mask: 0002h	Bit
			Increment Engine Start Counter	Mask: 0001h	Bit
450105	450104	4155	ControlBits 3		
			3-Position Controller Freq./Power raise	Mask: 8000h	Bit
			3-Position Controller Freq./Power lower	Mask: 4000h	Bit
			3-Position Controller Volt./ReactPow raise	Mask: 2000h	Bit
			3-Position Controller Volt./ReactPow lower	Mask: 1000h	Bit
			GCB is closed	Mask: 0800h	Bit
			MCB is closed	Mask: 0400h	Bit
			Power Derating is active	Mask: 0200h	Bit
			Synchronization GCB is active	Mask: 0100h	Bit
			Opening GCB is active	Mask: 0080h	Bit
			Closing GCB is active	Mask: 0040h	Bit
			Synchronization MCB is active	Mask: 0020h	Bit
			Opening MCB is active	Mask: 0010h	Bit
			Closing MCB is active	Mask: 0008h	Bit
			Unloading generator is active	Mask: 0004h	Bit
			Unloading mains is active	Mask: 0002h	Bit
			Power limited prerun	Mask: 0001h	Bit
450106	450105	4156	ControlBits 4		
			internal	Mask: 8000h	Bit
			internal	Mask: 4000h	Bit
			internal	Mask: 2000h	Bit
			internal	Mask: 1000h	Bit
			internal	Mask: 0800h	Bit
			Dead busbar closure request for GCB or MCB or GGB	Mask: 0400h	Bit
			Active power load share is active	Mask: 0200h	Bit
			Reactive power load share is active	Mask: 0100h	Bit
			Generator with a closed GCB is requested	Mask: 0080h	Bit



Modbus		Parameter ID	Description	Multiplier	Units
Modicon start addr.	Start addr. (*1)				
			LDSS: The Engine shall start	Mask: 0040h	Bit
			LDSS: The Engine shall stopped	Mask: 0020h	Bit
			LDSS: The Engine shall stopped, if possible	Mask: 0010h	Bit
			LDSS: Minimum Running Time is active	Mask: 0008h	Bit
			LDSS: The LDSS function is active	Mask: 0004h	Bit
			The Critical Mode Postrun is active	Mask: 0002h	Bit
			AUTOMATIC Run: Switch to Operating Mode STOP	Mask: 0001h	Bit
450107	450106		reserved		
450108	450107		reserved		
<b>Discrete Outputs</b>					
450109	450108	10107	Relay Outputs 1		
			Relay-Output 1 (inverted)	Mask: 8000h	Bit
			Relay-Output 2	Mask: 4000h	Bit
			Relay-Output 3	Mask: 2000h	Bit
			Relay-Output 4	Mask: 1000h	Bit
			Relay-Output 5	Mask: 0800h	Bit
			Relay-Output 6	Mask: 0400h	Bit
			Relay-Output 7	Mask: 0200h	Bit
			Relay-Output 8	Mask: 0100h	Bit
			Relay-Output 9	Mask: 0080h	Bit
			Relay-Output 10	Mask: 0040h	Bit
			Relay-Output 11	Mask: 0020h	Bit
			Relay-Output 12	Mask: 0010h	Bit
			internal	Mask: 0008h	Bit
			internal	Mask: 0004h	Bit
			internal	Mask: 0002h	Bit
			internal	Mask: 0001h	Bit
450110	450109		internal		
450111	450110	8005	Relay Outputs 3		
			External Discrete Output DO 16	Mask: 8000h	Bit
			External Discrete Output DO 15	Mask: 4000h	Bit
			External Discrete Output DO 14	Mask: 2000h	Bit
			External Discrete Output DO 13	Mask: 1000h	Bit
			External Discrete Output DO 12	Mask: 0800h	Bit
			External Discrete Output DO 11	Mask: 0400h	Bit

## Appendix

Data Protocols > Modbus > Protocol 5010 (Basic Visua...

Modbus		Parameter ID	Description	Multiplier	Units
Modicon start addr.	Start addr. (*1)				
			External Discrete Output DO 10	Mask: 0200h	Bit
			External Discrete Output DO 09	Mask: 0100h	Bit
			External Discrete Output DO 08	Mask: 0080h	Bit
			External Discrete Output DO 07	Mask: 0040h	Bit
			External Discrete Output DO 06	Mask: 0020h	Bit
			External Discrete Output DO 05	Mask: 0010h	Bit
			External Discrete Output DO 04	Mask: 0008h	Bit
			External Discrete Output DO 03	Mask: 0004h	Bit
			External Discrete Output DO 02	Mask: 0002h	Bit
			External Discrete Output DO 01	Mask: 0001h	Bit
450112	450111	8009	Relay Outputs 4		
			 only: External Discrete Output DO 32	Mask: 8000h	Bit
			 only: External Discrete Output DO 31	Mask: 4000h	Bit
			 only: External Discrete Output DO 30	Mask: 2000h	Bit
			 only: External Discrete Output DO 29	Mask: 1000h	Bit
			 only: External Discrete Output DO 28	Mask: 0800h	Bit
			 only: External Discrete Output DO 27	Mask: 0400h	Bit
			 only: External Discrete Output DO 26	Mask: 0200h	Bit
			 only: External Discrete Output DO 25	Mask: 0100h	Bit
			 only: External Discrete Output DO 24	Mask: 0080h	Bit
			 only: External Discrete Output DO 23	Mask: 0040h	Bit
			 only: External Discrete Output DO 22	Mask: 0020h	Bit
			 only: External Discrete Output DO 21	Mask: 0010h	Bit
			 only: External Discrete Output DO 20	Mask: 0008h	Bit
			 only: External Discrete Output DO 19	Mask: 0004h	Bit
			 only: External Discrete Output DO 18	Mask: 0002h	Bit
			 only: External Discrete Output DO 17	Mask: 0001h	Bit
450113	450112	4157	Command to CB-Control 1 (OR)	Mask: 8000h	Bit
			Command to CB-Control 2 (OR)	Mask: 4000h	Bit
			Command to CB-Control 3 (OR)	Mask: 2000h	Bit
			Command to CB-Control 4 (OR)	Mask: 1000h	Bit
			Command to CB-Control 5 (OR)	Mask: 0800h	Bit
			Command to CB-Control 6 (OR)	Mask: 0400h	Bit

Modbus		Parameter ID	Description	Multiplier	Units
Modicon start addr.	Start addr. (*1)				
			Gen excitation limit active	Mask: 0200h	Bit
			Neutral Interlocking	Mask: 0100h	Bit
			internal	Mask: 0080h	Bit
			internal	Mask: 0040h	Bit
			internal	Mask: 0020h	Bit
			internal	Mask: 0010h	Bit
			internal	Mask: 0008h	Bit
			internal	Mask: 0004h	Bit
			internal	Mask: 0002h	Bit
			internal	Mask: 0001h	Bit
450114	450113		reserved		
<b>Alarm Management</b>					
<b>General</b>					
450115	450114	10131	Alarm Class Latched		
			internal	Mask: 8000h	Bit
			internal	Mask: 4000h	Bit
			internal	Mask: 2000h	Bit
			internal	Mask: 1000h	Bit
			internal	Mask: 0800h	Bit
			internal	Mask: 0400h	Bit
			internal	Mask: 0200h	Bit
			internal	Mask: 0100h	Bit
			internal	Mask: 0080h	Bit
			internal	Mask: 0040h	Bit
			Alarm class F latched	Mask: 0020h	Bit
			Alarm class E latched	Mask: 0010h	Bit
			Alarm class D latched	Mask: 0008h	Bit
			Alarm class C latched	Mask: 0004h	Bit
			Alarm class B latched	Mask: 0002h	Bit
			Alarm class A latched	Mask: 0001h	Bit
450116	450115	10149	Alarms 2 latched (unacknowledged)		
		3064	GCB sync. Timeout	Mask: 8000h	Bit
		3074	MCB sync. Timeout	Mask: 4000h	Bit
		3084	internal	Mask: 2000h	Bit
		4056	Charge alt. low voltage (D+)	Mask: 1000h	Bit

## Appendix

Data Protocols > Modbus > Protocol 5010 (Basic Visua...

Modbus		Parameter ID	Description	Multiplier	Units
Modicon start addr.	Start addr. (*1)				
		2944	Phase rotation mismatch	Mask: 0800h	Bit
		10089	CAN bus overload	Mask: 0400h	Bit
		10083	internal	Mask: 0200h	Bit
		10082	internal	Mask: 0100h	Bit
		10086	internal	Mask: 0080h	Bit
		10085	internal	Mask: 0040h	Bit
		10088	CANopen error at CAN Interface 2	Mask: 0020h	Bit
		4073	Parameter Alignment	Mask: 0010h	Bit
		4064	Missing members on CAN	Mask: 0008h	Bit
		1714	EEPROM failure	Mask: 0004h	Bit
		15125	Red stop lamp DM1	Mask: 0002h	Bit
		15126	Amber warning lamp DM1	Mask: 0001h	Bit
450117	450116	-	Alarms 2 active (reserved)		
			internal	Mask: 8000h	Bit
			internal	Mask: 4000h	Bit
			internal	Mask: 2000h	Bit
			internal	Mask: 1000h	Bit
			internal	Mask: 0800h	Bit
			internal	Mask: 0400h	Bit
			internal	Mask: 0200h	Bit
			internal	Mask: 0100h	Bit
			internal	Mask: 0080h	Bit
			internal	Mask: 0040h	Bit
			internal	Mask: 0020h	Bit
			internal	Mask: 0010h	Bit
			internal	Mask: 0008h	Bit
			internal	Mask: 0004h	Bit
			internal	Mask: 0002h	Bit
			internal	Mask: 0001h	Bit
450118	450117	10190	Alarms 3 latched (unacknowledged)		
			internal	Mask: 8000h	Bit
			internal	Mask: 4000h	Bit
			internal	Mask: 2000h	Bit
			internal	Mask: 1000h	Bit
		14575	Temperature deviation level 1	Mask: 0800h	Bit

Modbus		Parameter ID	Description	Multiplier	Units
Modicon start addr.	Start addr. (*1)				
		14576	Temperature deviation level 2	Mask: 0400h	Bit
		14584	Temperature deviation wire break	Mask: 0200h	Bit
			internal	Mask: 0100h	Bit
			internal	Mask: 0080h	Bit
			internal	Mask: 0040h	Bit
			internal	Mask: 0020h	Bit
			internal	Mask: 0010h	Bit
			internal	Mask: 0008h	Bit
			internal	Mask: 0004h	Bit
			internal	Mask: 0002h	Bit
			internal	Mask: 0001h	Bit
450119	450118	-	Alarms 3 active (reserved)		
			internal	Mask: 8000h	Bit
			internal	Mask: 4000h	Bit
			internal	Mask: 2000h	Bit
			internal	Mask: 1000h	Bit
			internal	Mask: 0800h	Bit
			internal	Mask: 0400h	Bit
			internal	Mask: 0200h	Bit
			internal	Mask: 0100h	Bit
			internal	Mask: 0080h	Bit
			internal	Mask: 0040h	Bit
			internal	Mask: 0020h	Bit
			internal	Mask: 0010h	Bit
			internal	Mask: 0008h	Bit
			internal	Mask: 0004h	Bit
			internal	Mask: 0002h	Bit
			internal	Mask: 0001h	Bit
450120	450119		reserved		
<b>Engine</b>					
450121	450120	10133	Alarms 1 latched (unacknowledged)		
		2112	Overspeed 1	Mask: 8000h	Bit
		2113	Overspeed 2	Mask: 4000h	Bit
		2162	Underspeed 1	Mask: 2000h	Bit
		2163	Underspeed 2	Mask: 1000h	Bit

## Appendix

Data Protocols > Modbus > Protocol 5010 (Basic Visua...

Modbus		Parameter ID	Description	Multiplier	Units
Modicon start addr.	Start addr. (*1)				
		2652	Unintended stop	Mask: 0800h	Bit
		2457	Speed det. Alarm	Mask: 0400h	Bit
		2504	Shutdown malfunct.	Mask: 0200h	Bit
		2603	GCB fail to close	Mask: 0100h	Bit
		2604	GCB fail to open	Mask: 0080h	Bit
		2623	MCB fail to close	Mask: 0040h	Bit
		2624	MCB fail to open	Mask: 0020h	Bit
		10017	CAN-Fault J1939	Mask: 0010h	Bit
		3325	Start fail	Mask: 0008h	Bit
		2560	Mainten. days exceeded	Mask: 0004h	Bit
		2561	Mainten. hours exceeded	Mask: 0002h	Bit
		10087	CANopen error at CAN Interface 1	Mask: 0001h	Bit
450122	450121	-	Alarms 1 active (reserved)		
			internal	Mask: 8000h	Bit
			internal	Mask: 4000h	Bit
			internal	Mask: 2000h	Bit
			internal	Mask: 1000h	Bit
			internal	Mask: 0800h	Bit
			internal	Mask: 0400h	Bit
			internal	Mask: 0200h	Bit
			internal	Mask: 0100h	Bit
			internal	Mask: 0080h	Bit
			internal	Mask: 0040h	Bit
			internal	Mask: 0020h	Bit
			internal	Mask: 0010h	Bit
			internal	Mask: 0008h	Bit
			internal	Mask: 0004h	Bit
			internal	Mask: 0002h	Bit
			internal	Mask: 0001h	Bit
450123	450122	10136	Alarms Analog Inputs 1 latched (unacknowledged)		
			internal	Mask: 8000h	Bit
			internal	Mask: 4000h	Bit
			internal	Mask: 2000h	Bit
			internal	Mask: 1000h	Bit
			internal	Mask: 0800h	Bit

Modbus		Parameter ID	Description	Multiplier	Units
Modicon start addr.	Start addr. (*1)				
			internal	Mask: 0400h	Bit
			internal	Mask: 0200h	Bit
			internal	Mask: 0100h	Bit
			internal	Mask: 0080h	Bit
			internal	Mask: 0040h	Bit
			internal	Mask: 0020h	Bit
			internal	Mask: 0010h	Bit
		1008	Batt. overvolt.2	Mask: 0008h	Bit
		1007	Batt. undervolt.2	Mask: 0004h	Bit
		1006	Batt. overvolt.1	Mask: 0002h	Bit
		1005	Batt. undervolt.1	Mask: 0001h	Bit
450124	450123	-	Alarms Analog Inputs 1 active (reserved)		
			internal	Mask: 8000h	Bit
			internal	Mask: 4000h	Bit
			internal	Mask: 2000h	Bit
			internal	Mask: 1000h	Bit
			internal	Mask: 0800h	Bit
			internal	Mask: 0400h	Bit
			internal	Mask: 0200h	Bit
			internal	Mask: 0100h	Bit
			internal	Mask: 0080h	Bit
			internal	Mask: 0040h	Bit
			internal	Mask: 0020h	Bit
			internal	Mask: 0010h	Bit
			internal	Mask: 0008h	Bit
			internal	Mask: 0004h	Bit
			internal	Mask: 0002h	Bit
			internal	Mask: 0001h	Bit
450125	450124		reserved		
450126	450125		reserved		
<b>Generator</b>					
450127	450126	10134	Alarms Generator latched (unacknowledged)		
		1912	Gen. overfreq. 1	Mask: 8000h	Bit
		1913	Gen. overfreq. 2	Mask: 4000h	Bit
		1962	Gen. underfreq. 1	Mask: 2000h	Bit

## Appendix

Data Protocols > Modbus > Protocol 5010 (Basic Visua...

Modbus		Parameter ID	Description	Multiplier	Units
Modicon start addr.	Start addr. (*1)				
		1963	Gen. underfreq. 2	Mask: 1000h	Bit
		2012	Gen. overvolt. 1	Mask: 0800h	Bit
		2013	Gen. overvolt. 2	Mask: 0400h	Bit
		2062	Gen. undervolt. 1	Mask: 0200h	Bit
		2063	Gen. undervolt. 2	Mask: 0100h	Bit
		2218	Gen. overcurr. 1	Mask: 0080h	Bit
		2219	Gen. overcurr. 2	Mask: 0040h	Bit
		2220	Gen. overcurr. 3	Mask: 0020h	Bit
		2262	Gen. Rv/Rd pow.1	Mask: 0010h	Bit
		2263	Gen. Rv/Rd pow.2	Mask: 0008h	Bit
		2314	Gen. Overload IOP 1	Mask: 0004h	Bit
		2315	Gen. Overload IOP 2	Mask: 0002h	Bit
			internal	Mask: 0001h	Bit
450128	450127	-	Alarms Generator active (reserved)		
			internal	Mask: 8000h	Bit
			internal	Mask: 4000h	Bit
			internal	Mask: 2000h	Bit
			internal	Mask: 1000h	Bit
			internal	Mask: 0800h	Bit
			internal	Mask: 0400h	Bit
			internal	Mask: 0200h	Bit
			internal	Mask: 0100h	Bit
			internal	Mask: 0080h	Bit
			internal	Mask: 0040h	Bit
			internal	Mask: 0020h	Bit
			internal	Mask: 0010h	Bit
			internal	Mask: 0008h	Bit
			internal	Mask: 0004h	Bit
			internal	Mask: 0002h	Bit
			internal	Mask: 0001h	Bit
450129	450128	10138	Alarms Generator 1 latched (unacknowledged)		
		2412	Unbal. load 1	Mask: 8000h	Bit
		2413	Unbal. load 2	Mask: 4000h	Bit
		3907	Gen. Asymmetry	Mask: 2000h	Bit
		3263	Ground fault 1	Mask: 1000h	Bit



Modbus		Parameter ID	Description	Multiplier	Units
Modicon start addr.	Start addr. (*1)				
		3264	Ground fault 2	Mask: 0800h	Bit
		3955	Gen. phase rot. misw.	Mask: 0400h	Bit
		2924	Gen act. pwr mismatch	Mask: 0200h	Bit
		3124	Gen. unloading fault	Mask: 0100h	Bit
		4038	Inv. time ov.curr.	Mask: 0080h	Bit
		2664	Operating range failed,	Mask: 0040h	Bit
		2362	Gen. Overload MOP 1	Mask: 0020h	Bit
		2363	Gen. Overload MOP 2	Mask: 0010h	Bit
		2337	Gen. overexcited 1	Mask: 0008h	Bit
		2338	Gen. overexcited 2	Mask: 0004h	Bit
		2387	Gen. underexcited 1	Mask: 0002h	Bit
		2388	Gen. underexcited 2	Mask: 0001h	Bit
450130	450129	-	Alarms Generator 1 active (reserved)		
			internal	Mask: 8000h	Bit
			internal	Mask: 4000h	Bit
			internal	Mask: 2000h	Bit
			internal	Mask: 1000h	Bit
			internal	Mask: 0800h	Bit
			internal	Mask: 0400h	Bit
			internal	Mask: 0200h	Bit
			internal	Mask: 0100h	Bit
			internal	Mask: 0080h	Bit
			internal	Mask: 0040h	Bit
			internal	Mask: 0020h	Bit
			internal	Mask: 0010h	Bit
			internal	Mask: 0008h	Bit
			internal	Mask: 0004h	Bit
			internal	Mask: 0002h	Bit
			internal	Mask: 0001h	Bit
450131	450130		reserved		
450132	450131		reserved		
<b>Mains</b>					
450133	450132	10135	Alarms Mains latched (unacknowledged)		
		2862	Mains ov.freq. 1	Mask: 8000h	Bit
		2863	Mains ov.freq. 2	Mask: 4000h	Bit

## Appendix

Data Protocols > Modbus > Protocol 5010 (Basic Visua...

Modbus		Parameter ID	Description	Multiplier	Units
Modicon start addr.	Start addr. (*1)				
		2912	Mains un.freq. 1	Mask: 2000h	Bit
		2913	Mains un.freq. 2	Mask: 1000h	Bit
		2962	Mains ov.volt. 1	Mask: 0800h	Bit
		2963	Mains ov.volt. 2	Mask: 0400h	Bit
		3012	Mains un.volt. 1	Mask: 0200h	Bit
		3013	Mains un.volt. 2	Mask: 0100h	Bit
		3057	Mains phaseshift	Mask: 0080h	Bit
		3114	Mains decoupling	Mask: 0040h	Bit
			internal	Mask: 0020h	Bit
			internal	Mask: 0010h	Bit
			internal	Mask: 0008h	Bit
		3975	Mains phase rot. Miswired	Mask: 0004h	Bit
			internal	Mask: 0002h	Bit
			internal	Mask: 0001h	Bit
450134	450133	-	Alarms Mains active (reserved)		
			internal	Mask: 8000h	Bit
			internal	Mask: 4000h	Bit
			internal	Mask: 2000h	Bit
			internal	Mask: 1000h	Bit
			internal	Mask: 0800h	Bit
			internal	Mask: 0400h	Bit
			internal	Mask: 0200h	Bit
			internal	Mask: 0100h	Bit
			internal	Mask: 0080h	Bit
			internal	Mask: 0040h	Bit
			internal	Mask: 0020h	Bit
			internal	Mask: 0010h	Bit
			internal	Mask: 0008h	Bit
			internal	Mask: 0004h	Bit
			internal	Mask: 0002h	Bit
			internal	Mask: 0001h	Bit
450135	450134	4189	Alarms Mains 1 latched (unacknowledged)		
		3217	Mains import power 1	Mask: 8000h	Bit
		3218	Mains import power 2	Mask: 4000h	Bit
		3241	Mains export power 1	Mask: 2000h	Bit

Modbus		Parameter ID	Description	Multiplier	Units
Modicon start addr.	Start addr. (*1)				
		3242	Mains export power 2	Mask: 1000h	Bit
		2985	Mains overexcited 1	Mask: 0800h	Bit
		2986	Mains overexcited 2	Mask: 0400h	Bit
		3035	Mains underexcited 1	Mask: 0200h	Bit
		3036	Mains underexcited 2	Mask: 0100h	Bit
		3106	Mains df/dt	Mask: 0080h	Bit
		2934	Mns act. pwr mismatch	Mask: 0040h	Bit
		4958	Mains. Time dep. Voltage	Mask: 0020h	Bit
			internal	Mask: 0010h	Bit
		8834	Mains Voltage Increase	Mask: 0008h	Bit
			internal	Mask: 0004h	Bit
		3288	Mains QV Monitoring step 1	Mask: 0002h	Bit
		3289	Mains QV Monitoring step 2	Mask: 0001h	Bit
450136	450135	-	Alarms Mains 1 active (reserved)		
			internal	Mask: 8000h	Bit
			internal	Mask: 4000h	Bit
			internal	Mask: 2000h	Bit
			internal	Mask: 1000h	Bit
			internal	Mask: 0800h	Bit
			internal	Mask: 0400h	Bit
			internal	Mask: 0200h	Bit
			internal	Mask: 0100h	Bit
			internal	Mask: 0080h	Bit
			internal	Mask: 0040h	Bit
			internal	Mask: 0020h	Bit
			internal	Mask: 0010h	Bit
			internal	Mask: 0008h	Bit
			internal	Mask: 0004h	Bit
			internal	Mask: 0002h	Bit
			internal	Mask: 0001h	Bit
450137	450136		reserved		
450138	450137		reserved		
<b>Digital Inputs</b>					
450139	450138	10132	Alarms Digital Inputs 1 latched (unacknowledged)		
		10600	Digital Input 1	Mask: 8000h	Bit

## Appendix

Data Protocols > Modbus > Protocol 5010 (Basic Visua...

Modbus		Parameter ID	Description	Multiplier	Units
Modicon start addr.	Start addr. (*1)				
		10601	Digital Input 2	Mask: 4000h	Bit
		10602	Digital Input 3	Mask: 2000h	Bit
		10603	Digital Input 4	Mask: 1000h	Bit
		10604	Digital Input 5	Mask: 0800h	Bit
		10605	Digital Input 6	Mask: 0400h	Bit
		10607	Digital Input 7	Mask: 0200h	Bit
		10608	Digital Input 8 (reply GCB)	Mask: 0100h	Bit
		10609	Digital Input 9	Mask: 0080h	Bit
		10610	Digital Input 10	Mask: 0040h	Bit
		10611	Digital Input 11	Mask: 0020h	Bit
		10612	Digital Input 12	Mask: 0010h	Bit
			internal	Mask: 0008h	Bit
			internal	Mask: 0004h	Bit
			internal	Mask: 0002h	Bit
			internal	Mask: 0001h	Bit
450140	450139	-	Alarms Digital Inputs 1 active (reserved)		
			internal	Mask: 8000h	Bit
			internal	Mask: 4000h	Bit
			internal	Mask: 2000h	Bit
			internal	Mask: 1000h	Bit
			internal	Mask: 0800h	Bit
			internal	Mask: 0400h	Bit
			internal	Mask: 0200h	Bit
			internal	Mask: 0100h	Bit
			internal	Mask: 0080h	Bit
			internal	Mask: 0040h	Bit
			internal	Mask: 0020h	Bit
			internal	Mask: 0010h	Bit
			internal	Mask: 0008h	Bit
			internal	Mask: 0004h	Bit
			internal	Mask: 0002h	Bit
			internal	Mask: 0001h	Bit
450141	450140	16377	Alarms External Digital Inputs latched (unacknowledged)		
		16376	State external Digital Input 16	Mask: 8000h	Bit
		16375	External Digital Input 15	Mask: 4000h	Bit

Modbus		Parameter ID	Description	Multiplier	Units
Modicon start addr.	Start addr. (*1)				
		16374	External Digital Input 14	Mask: 2000h	Bit
		16373	External Digital Input 13	Mask: 1000h	Bit
		16372	External Digital Input 12	Mask: 0800h	Bit
		16371	External Digital Input 11	Mask: 0400h	Bit
		16370	External Digital Input 10	Mask: 0200h	Bit
		16369	External Digital Input 9	Mask: 0100h	Bit
		16368	External Digital Input 8	Mask: 0080h	Bit
		16367	External Digital Input 7	Mask: 0040h	Bit
		16366	External Digital Input 6	Mask: 0020h	Bit
		16365	External Digital Input 5	Mask: 0010h	Bit
		16364	External Digital Input 4	Mask: 0008h	Bit
		16362	External Digital Input 3	Mask: 0004h	Bit
		16361	External Digital Input 2	Mask: 0002h	Bit
		16360	External Digital Input 1	Mask: 0001h	Bit
450142	450141	-	Alarms External Digital Inputs active (reserved)		
			internal	Mask: 8000h	Bit
			internal	Mask: 4000h	Bit
			internal	Mask: 2000h	Bit
			internal	Mask: 1000h	Bit
			internal	Mask: 0800h	Bit
			internal	Mask: 0400h	Bit
			internal	Mask: 0200h	Bit
			internal	Mask: 0100h	Bit
			internal	Mask: 0080h	Bit
			internal	Mask: 0040h	Bit
			internal	Mask: 0020h	Bit
			internal	Mask: 0010h	Bit
			internal	Mask: 0008h	Bit
			internal	Mask: 0004h	Bit
			internal	Mask: 0002h	Bit
			internal	Mask: 0001h	Bit
450143	450142	-	Alarm External Digital Inputs 1 latched (unacknowledged)		
		16352	internal  only: External Digital Input 32	Mask: 8000h	Bit

## Appendix

Data Protocols > Modbus > Protocol 5010 (Basic Visua...

Modbus		Parameter ID	Description	Multiplier	Units
Modicon start addr.	Start addr. (*1)				
		16342	<input type="checkbox"/> P2 only: External Digital Input 31	Mask: 4000h	Bit
		16332	<input type="checkbox"/> P2 only: External Digital Input 30	Mask: 2000h	Bit
		16322	<input type="checkbox"/> P2 only: External Digital Input 29	Mask: 1000h	Bit
		16312	<input type="checkbox"/> P2 only: External Digital Input 28	Mask: 0800h	Bit
		16302	<input type="checkbox"/> P2 only: External Digital Input 27	Mask: 0400h	Bit
		16292	<input type="checkbox"/> P2 only: External Digital Input 26	Mask: 0200h	Bit
		16282	<input type="checkbox"/> P2 only: External Digital Input 25	Mask: 0100h	Bit
		16272	<input type="checkbox"/> P2 only: External Digital Input 24	Mask: 0080h	Bit
		16262	<input type="checkbox"/> P2 only: External Digital Input 23	Mask: 0040h	Bit
		16252	<input type="checkbox"/> P2 only: External Digital Input 22	Mask: 0020h	Bit
		16242	<input type="checkbox"/> P2 only: External Digital Input 21	Mask: 0010h	Bit
		16232	<input type="checkbox"/> P2 only: External Digital Input 20	Mask: 0008h	Bit
		16222	<input type="checkbox"/> P2 only: External Digital Input 19	Mask: 0004h	Bit
		16212	<input type="checkbox"/> P2 only: External Digital Input 18	Mask: 0002h	Bit
		16202	<input type="checkbox"/> P2 only: External Digital Input 17	Mask: 0001h	Bit
450144	450143	-	Alarm External Digital Inputs 1 active (reserved)		
			internal	Mask: 8000h	Bit
			internal	Mask: 4000h	Bit
			internal	Mask: 2000h	Bit
			internal	Mask: 1000h	Bit
			internal	Mask: 0800h	Bit
			internal	Mask: 0400h	Bit
			internal	Mask: 0200h	Bit
			internal	Mask: 0100h	Bit
			internal	Mask: 0080h	Bit
			internal	Mask: 0040h	Bit
			internal	Mask: 0020h	Bit
			internal	Mask: 0010h	Bit
			internal	Mask: 0008h	Bit
			internal	Mask: 0004h	Bit
			internal	Mask: 0002h	Bit
			internal	Mask: 0001h	Bit
450145	450144	-	internal		

Modbus		Parameter ID	Description	Multiplier	Units
Modicon start addr.	Start addr. (*1)				
450146	450145	-	Alarms Digital Inputs 2 active (reserved)		
			reserved		
			reserved		
			reserved		
			reserved		
			reserved		
			reserved		
			reserved		
			reserved		
			reserved		
			reserved		
			reserved		
			internal	Mask: 0010h	Bit
			internal	Mask: 0008h	Bit
			internal	Mask: 0004h	Bit
			internal	Mask: 0002h	Bit
			internal	Mask: 0001h	Bit
450147	450146		reserved		
450148	450147		reserved		
450149	450148		reserved		
450150	450149		reserved		
<b>Flexible Thresholds</b>					
450151	450150	-	Alarms Flexible thresholds 1-16 latched (unacknowledged)		
		10033	Alarm flexible limit 16	Mask: 8000h	Bit
		10032	Alarm flexible limit 15	Mask: 4000h	Bit
		10031	Alarm flexible limit 14	Mask: 2000h	Bit
		10030	Alarm flexible limit 13	Mask: 1000h	Bit
		10029	Alarm flexible limit 12	Mask: 0800h	Bit
		10028	Alarm flexible limit 11	Mask: 0400h	Bit
		10027	Alarm flexible limit 10	Mask: 0200h	Bit
		10026	Alarm flexible limit 9	Mask: 0100h	Bit
		10025	Alarm flexible limit 8	Mask: 0080h	Bit
		10024	Alarm flexible limit 7	Mask: 0040h	Bit
		10023	Alarm flexible limit 6	Mask: 0020h	Bit
		10022	Alarm flexible limit 5	Mask: 0010h	Bit

## Appendix

Data Protocols > Modbus > Protocol 5010 (Basic Visua...

Modbus		Parameter ID	Description	Multiplier	Units
Modicon start addr.	Start addr. (*1)				
		10021	Alarm flexible limit 4	Mask: 0008h	Bit
		10020	Alarm flexible limit 3	Mask: 0004h	Bit
		10019	Alarm flexible limit 2	Mask: 0002h	Bit
		10018	Alarm flexible limit 1	Mask: 0001h	Bit
450152	450151	-	Alarms Flexible thresholds 1-16 active (reserved)		
			internal	Mask: 8000h	Bit
			internal	Mask: 4000h	Bit
			internal	Mask: 2000h	Bit
			internal	Mask: 1000h	Bit
			internal	Mask: 0800h	Bit
			internal	Mask: 0400h	Bit
			internal	Mask: 0200h	Bit
			internal	Mask: 0100h	Bit
			internal	Mask: 0080h	Bit
			internal	Mask: 0040h	Bit
			internal	Mask: 0020h	Bit
			internal	Mask: 0010h	Bit
			internal	Mask: 0008h	Bit
			internal	Mask: 0004h	Bit
			internal	Mask: 0002h	Bit
			internal	Mask: 0001h	Bit
450153	450152	-	Alarms Flexible thresholds 17-32 latched (unacknowledged)		
		10049	Alarm flexible limit 32	Mask: 8000h	Bit
		10048	Alarm flexible limit 31	Mask: 4000h	Bit
		10047	Alarm flexible limit 30	Mask: 2000h	Bit
		10046	Alarm flexible limit 29	Mask: 1000h	Bit
		10045	Alarm flexible limit 28	Mask: 0800h	Bit
		10044	Alarm flexible limit 27	Mask: 0400h	Bit
		10043	Alarm flexible limit 26	Mask: 0200h	Bit
		10042	Alarm flexible limit 25	Mask: 0100h	Bit
		10041	Alarm flexible limit 24	Mask: 0080h	Bit
		10040	Alarm flexible limit 23	Mask: 0040h	Bit
		10039	Alarm flexible limit 22	Mask: 0020h	Bit
		10038	Alarm flexible limit 21	Mask: 0010h	Bit









Modbus		Parameter ID	Description	Multiplier	Units
Modicon start addr.	Start addr. (*1)				
		10037	Alarm flexible limit 20	Mask: 0008h	Bit
		10036	Alarm flexible limit 19	Mask: 0004h	Bit
		10035	Alarm flexible limit 18	Mask: 0002h	Bit
		10034	Alarm flexible limit 17	Mask: 0001h	Bit
450154	450153	-	Alarms Flexible thresholds 17-32 active (reserved)		
			internal	Mask: 8000h	Bit
			internal	Mask: 4000h	Bit
			internal	Mask: 2000h	Bit
			internal	Mask: 1000h	Bit
			internal	Mask: 0800h	Bit
			internal	Mask: 0400h	Bit
			internal	Mask: 0200h	Bit
			internal	Mask: 0100h	Bit
			internal	Mask: 0080h	Bit
			internal	Mask: 0040h	Bit
			internal	Mask: 0020h	Bit
			internal	Mask: 0010h	Bit
			internal	Mask: 0008h	Bit
			internal	Mask: 0004h	Bit
			internal	Mask: 0002h	Bit
			internal	Mask: 0001h	Bit
450155	450154		Alarms Flexible thresholds 33-40 latched (unacknowledged)		
			internal	Mask: 8000h	Bit
			internal	Mask: 4000h	Bit
			internal	Mask: 2000h	Bit
			internal	Mask: 1000h	Bit
			internal	Mask: 0800h	Bit
			internal	Mask: 0400h	Bit
			internal	Mask: 0200h	Bit
			internal	Mask: 0100h	Bit
		10057	Alarm flexible limit 40	Mask: 0080h	Bit
		10056	Alarm flexible limit 39	Mask: 0040h	Bit
		10055	Alarm flexible limit 38	Mask: 0020h	Bit
		10054	Alarm flexible limit 37	Mask: 0010h	Bit

## Appendix









Data Protocols > Modbus > Protocol 5010 (Basic Visua...

Modbus		Parameter ID	Description	Multiplier	Units
Modicon start addr.	Start addr. (*1)				
		10053	Alarm flexible limit 36	Mask: 0008h	Bit
		10052	Alarm flexible limit 35	Mask: 0004h	Bit
		10051	Alarm flexible limit 34	Mask: 0002h	Bit
		10050	Alarm flexible limit 33	Mask: 0001h	Bit
450156	450155		Alarms Flexible thresholds 33-40 active (reserved)		
			internal	Mask: 8000h	Bit
			internal	Mask: 4000h	Bit
			internal	Mask: 2000h	Bit
			internal	Mask: 1000h	Bit
			internal	Mask: 0800h	Bit
			internal	Mask: 0400h	Bit
			internal	Mask: 0200h	Bit
			internal	Mask: 0100h	Bit
			internal	Mask: 0080h	Bit
			internal	Mask: 0040h	Bit
			internal	Mask: 0020h	Bit
			internal	Mask: 0010h	Bit
			internal	Mask: 0008h	Bit
			internal	Mask: 0004h	Bit
			internal	Mask: 0002h	Bit
			internal	Mask: 0001h	Bit
450157	450156		reserved		
450158	450157		reserved		
450159	450158		reserved		
<b>DC Analogue Values Wirebreak</b>					
450160	450159	10137	Alarms Analog Inputs Wire Break latched (unacknowledged)		
			internal	Mask: 0001h	Bit
		10014	Analog inp. 1, wire break	Mask: 0002h	Bit
		10015	Analog inp. 2, wire break	Mask: 0004h	Bit
		10060	Analog inp. 3, wire break	Mask: 0008h	Bit
		10061	internal	Mask: 0010h	Bit
			internal	Mask: 0020h	Bit
			internal	Mask: 0040h	Bit
			internal	Mask: 0080h	Bit

Modbus		Parameter ID	Description	Multiplier	Units
Modicon start addr.	Start addr. (*1)				
			internal	Mask: 0100h	Bit
			internal	Mask: 0200h	Bit
			internal	Mask: 0400h	Bit
			internal	Mask: 0800h	Bit
			internal	Mask: 1000h	Bit
			internal	Mask: 2000h	Bit
			internal	Mask: 4000h	Bit
			internal	Mask: 8000h	Bit
450161	450160		Alarms Analog Inputs Wire Break active (reserved)		
			internal	Mask: 0001h	Bit
			internal	Mask: 0002h	Bit
			internal	Mask: 0004h	Bit
			internal	Mask: 0008h	Bit
			internal	Mask: 0010h	Bit
			internal	Mask: 0020h	Bit
			internal	Mask: 0040h	Bit
			internal	Mask: 0080h	Bit
			internal	Mask: 0100h	Bit
			internal	Mask: 0200h	Bit
			internal	Mask: 0400h	Bit
			internal	Mask: 0800h	Bit
			internal	Mask: 1000h	Bit
			internal	Mask: 2000h	Bit
			internal	Mask: 4000h	Bit
			internal	Mask: 8000h	Bit
450162	450161	-	Alarms External Analog Inputs Wire Break latched (unacknowledged)		
		10221	 only: Ext. Analog Inp. 1, wire break	Mask: 0001h	Bit
		10222	 only: Ext. Analog Inp.2, wire break	Mask: 0002h	Bit
		10223	 only: Ext. Analog Inp. 3, wire break	Mask: 0004h	Bit
		10224	 only: Ext. Analog Inp. 4, wire break	Mask: 0008h	Bit
		10225	 only: Ext. Analog Inp. 5, wire break	Mask: 0010h	Bit
		10226	 only: Ext. Analog Inp. 6, wire break	Mask: 0020h	Bit
		10227	 only: Ext. Analog Inp. 7, wire break	Mask: 0040h	Bit

## Appendix

Data Protocols > Modbus > Protocol 5010 (Basic Visua...

Modbus		Parameter ID	Description	Multiplier	Units
Modicon start addr.	Start addr. (*1)				
		10228	 only: Ext. Analog Inp. 8, wire break	Mask: 0080h	Bit
		10229	 only: Ext. Analog Inp. 9, wire break	Mask: 0100h	Bit
		10230	 only: Ext. Analog Inp. 10, wire break	Mask: 0200h	Bit
		10231	 only: Ext. Analog Inp. 11, wire break	Mask: 0400h	Bit
		10232	 only: Ext. Analog Inp. 12, wire break	Mask: 0800h	Bit
		10233	 only: Ext. Analog Inp. 13, wire break	Mask: 1000h	Bit
		10234	 only: Ext. Analog Inp. 14, wire break	Mask: 2000h	Bit
		10235	 only: Ext. Analog Inp. 15, wire break	Mask: 4000h	Bit
		10236	 only: Ext. Analog Inp. 16, wire break	Mask: 8000h	Bit
450163	450162	-	Alarms External Analog Inputs Wire Break active (reserved)		
			internal	Mask: 0001h	Bit
			internal	Mask: 0002h	Bit
			internal	Mask: 0004h	Bit
			internal	Mask: 0008h	Bit
			internal	Mask: 0010h	Bit
			internal	Mask: 0020h	Bit
			internal	Mask: 0040h	Bit
			internal	Mask: 0080h	Bit
			internal	Mask: 0100h	Bit
			internal	Mask: 0200h	Bit
			internal	Mask: 0400h	Bit
			internal	Mask: 0800h	Bit
			internal	Mask: 1000h	Bit
			internal	Mask: 2000h	Bit
			internal	Mask: 4000h	Bit
			internal	Mask: 8000h	Bit
450164	450163		reserved		
450165	450164		reserved		
<b>Alarms</b>					
450166	450165	5195	internal	Mask: 8000h	Bit
		5189	internal	Mask: 4000h	Bit
		5183	Free alarm 4	Mask: 2000h	Bit
		5177	Free alarm 3	Mask: 1000h	Bit
		5171	Free alarm 2	Mask: 0800h	Bit

Modbus		Parameter ID	Description	Multiplier	Units
Modicon start addr.	Start addr. (*1)				
		5165	Free alarm 1	Mask: 0400h	Bit
		5159	internal	Mask: 0200h	Bit
		5153	Neutral contactor reply mismatch	Mask: 0100h	Bit
		5147	Decoupling GCB↔MCB	Mask: 0080h	Bit
		5141	Meas. difference 4105 VDE-AR-N 4105	Mask: 0040h	Bit
		5135	Parameter alignment VDE-AR-N 4105	Mask: 0020h	Bit
		5129	Missing member VDE-AR-N 4105	Mask: 0010h	Bit
			internal	Mask: 0008h	Bit
			internal	Mask: 0004h	Bit
			internal	Mask: 0002h	Bit
			internal	Mask: 0001h	Bit
450167	450166	-	special Alarms active (reserved)		
			internal	Mask: 8000h	Bit
			internal	Mask: 4000h	Bit
			internal	Mask: 2000h	Bit
			internal	Mask: 1000h	Bit
			internal	Mask: 0800h	Bit
			internal	Mask: 0400h	Bit
			internal	Mask: 0200h	Bit
			internal	Mask: 0100h	Bit
			internal	Mask: 0080h	Bit
			internal	Mask: 0040h	Bit
			internal	Mask: 0020h	Bit
			internal	Mask: 0010h	Bit
			internal	Mask: 0008h	Bit
			internal	Mask: 0004h	Bit
			internal	Mask: 0002h	Bit
			internal	Mask: 0001h	Bit
450168	450167		reserved		
450169	450168		reserved		
450170	450169		reserved		
450171	450170		reserved		
<b>Engine Management</b>					
<b>Active Diagnostic Trouble Code (DM1)</b>					
450172	450171	15400	SPN of 1. entry	low 16 bits of 19 bits of SPN	

## Appendix

Data Protocols > Modbus > Protocol 5010 (Basic Visua...

Modbus		Parameter ID	Description	Multiplier	Units
Modicon start addr.	Start addr. (*1)				
450173	450172	15401 15402	FMI / OC of 1. entry	Hi-Byte: FMI Lo-Byte: OC	
450174	450173	15403	SPN of 2. entry	low 16 bits of 19 bits of SPN	
450175	450174	15404 15405	FMI / OC of 2. entry	Hi-Byte: FMI Lo-Byte: OC	
450176	450175	15406	SPN of 3. entry	low 16 bits of 19 bits of SPN	
450177	450176	15407 15408	FMI / OC of 3. entry	Hi-Byte: FMI Lo-Byte: OC	
450178	450177	15409	SPN of 4. entry	low 16 bits of 19 bits of SPN	
450179	450178	15410 15411	FMI / OC of 4. entry	Hi-Byte: FMI Lo-Byte: OC	
450180	450179	15412	SPN of 5. entry	low 16 bits of 19 bits of SPN	
450181	450180	15413 15414	FMI / OC of 5. entry	Hi-Byte: FMI Lo-Byte: OC	
450182	450181	15415	SPN of 6. entry	low 16 bits of 19 bits of SPN	
450183	450182	15416 15418	FMI / OC of 6. entry	Hi-Byte: FMI Lo-Byte: OC	
450184	450183	15419	SPN of 7. entry	low 16 bits of 19 bits of SPN	
450185	450184	15420 15421	FMI / OC of 7. entry	Hi-Byte: FMI Lo-Byte: OC	
450186	450185	15422	SPN of 8. entry	low 16 bits of 19 bits of SPN	
450187	450186	15423 15424	FMI / OC of 8. entry	Hi-Byte: FMI Lo-Byte: OC	
450188	450187	15425	SPN of 9. entry	low 16 bits of 19 bits of SPN	
450189	450188	15426 15427	FMI / OC of 9. entry	Hi-Byte: FMI Lo-Byte: OC	
450190	450189	15428	SPN of 10. entry	low 16 bits of 19 bits of SPN	
450191	450190	15429 15430	FMI / OC of 10. entry	Hi-Byte: FMI Lo-Byte: OC	
<b>DM1 Lamp Status</b>					
450192	450191	15395	J1939 Lamp Status DM1		
			internal	Mask 8000h	
			internal	Mask 4000h	
			On Malfunction Lamp	Mask 2000h	
			Off Malfunction Lamp	Mask 1000h	
			internal	Mask 0800h	
			internal	Mask 0400h	
			On Red Stop Lamp	Mask 0200h	
			Off Red Stop Lamp	Mask 0100h	
			internal	Mask 0080h	
			internal	Mask 0040h	
			On Amber Warning Lamp	Mask 0020h	
			Off Amber Warning Lamp	Mask 0010h	
			internal	Mask 0008h	
			internal	Mask 0004h	

Modbus		Parameter ID	Description	Multiplier	Units
Modicon start addr.	Start addr. (*1)				
			On Protect Lamp	Mask 0002h	
			Off Protect Lamp	Mask 0001h	
<b>DM2 Lamp Status</b>					
450193	450192	15445	J1939 Lamp Status DM2		
			internal	Mask 8000h	
			internal	Mask 4000h	
			On Malfunction Lamp	Mask 2000h	
			Off Malfunction Lamp	Mask 1000h	
			internal	Mask 0800h	
			internal	Mask 0400h	
			On Red Stop Lamp	Mask 0200h	
			Off Red Stop Lamp	Mask 0100h	
			internal	Mask 0080h	
			internal	Mask 0040h	
			On Amber Warning Lamp	Mask 0020h	
			Off Amber Warning Lamp	Mask 0010h	
			internal	Mask 0008h	
			internal	Mask 0004h	
			On Protect Lamp	Mask 0002h	
			Off Protect Lamp	Mask 0001h	
<b>Special Failure Codes</b>					
450194	450193	15109	J1939 MTU ADEC ECU Failure Codes	1	
450195	450194		reserved		
450196	450195	15304	J1939 Engine Stop Information (e.g., DEUTZ-specific EMR2 J1939-Message). Please refer to specific ECU documentation for details.	"Missing" Value="65535" "Error" Value="65279" Engine stop information value is 0 to 250	
450197	450196		reserved		
450198	450197	15305	J1939 DLN2-Message Scania S6		
			Engine Coolant Temperature		
			J1939-Message not available	Mask 8000h	
			Sensor fault	Mask 4000h	
			High Temperature.	Mask 2000h	
			NOT High Temperature	Mask 1000h	
			Engine Oil Pressure		
		J1939-Message not available	Mask 0800h		

## Appendix

Data Protocols > Modbus > Protocol 5010 (Basic Visua...

Modbus		Parameter ID	Description	Multiplier	Units
Modicon start addr.	Start addr. (*1)				
			Sensor fault	Mask 0400h	
			Low Pressure	Mask 0200h	
			NOT Low Pressure	Mask 0100h	
			High Engine Oil Level		
			J1939-Message not available	Mask 0080h	
			Sensor fault	Mask 0040h	
			High Level	Mask 0020h	
			NOT High Level	Mask 0010h	
			Low Engine Oil Level		
			J1939-Message not available	Mask 0008h	
			Sensor fault	Mask 0004h	
			Low Level	Mask 0002h	
			NOT Low Level	Mask 0001h	
450199	450198		reserved		
450200	450199		reserved		
450201	450200		reserved		
<b>Values</b>					
450202	450201	15308	Engine Speed (SPN 190)	1	rpm
450203	450202	15202	Engine Coolant Temperature (SPN 110)	1	°C
450204	450203	15203	Fuel temperature (SPN 174)	1	°C
450205	450204	15309	Engine Oil Temperature 1 (SPN 175)	0,1	°C
450206	450205	15205	Engine Oil Pressure (SPN 100)	1	kPa
450207	450206	15307	Fuel Rate (SPN 183)	0,1	L/h
450208	450207	15206	Coolant Level (SPN 111)	0,1	%
450209	450208	15207	Throttle position (SPN 91)	0,1	%
450210	450209	15208	Load at current Speed (SPN 92)	1	%
450211	450210	15210	Engine oil level (SPN 98)	0,1	%
450212	450211	15214	Boost pressure (SPN 102)	1	kPa
450213	450212	15215	Intake Manifold 1 Temp (SPN 105)	1	°C
450214	450213	15212	Barometric Pressure (SPN 108)	0,1	kPa
450215	450214	15213	Air inlet temperature (SPN 172)	1	°C
450216	450215	15209	Actual engine torque (SPN 513)	1	%
450217	450216	15299	Exhaust Gas Temp.(SPN 173)	0,1	°C
450218	450217	15217	Engine Intercooler Temp (SPN52)	1	°C
450219	450218	15218	Fuel Delivery Pressure (SPN94)	1	kPa



Modbus		Parameter ID	Description	Multiplier	Units
Modicon start addr.	Start addr. (*1)				
450220	450219	15219	Fuel Filter Differential Pressure (SPN95)	1	kPa
450221	450220	15220	Crankcase Pressure (SPN101)	1	kPa
450222	450221	15221	Turbo Air Inlet Pressure (SPN106)	1	kPa
450223	450222	15222	Air Filter 1 Differential Pressure (SPN107)	0,01	kPa
450224	450223	15223	Coolant Pressure (SPN109)	1	kPa
450225	450224	15224	Transmission Oil Pressure (SPN127)	1	kPa
450226	450225	15225	Fuel Rail Pressure (SPN157)	0,1	MPa
450227	450226	15226	Ambient Air Temperature (SPN171)	0,1	°C
450228	450227	15227	Turbo Oil Temperature (SPN176)	0,1	°C
450229	450228	15228	Transmission Oil Temperature (SPN177)	0,1	°C
450230	450229	15229	Auxiliary Temperature 1 (SPN441)	1	°C
450231	450230	15230	Auxiliary Temperature 2 (SPN442)	1	°C
450232	450231	15209	Actual Engine Torque (SPN513)	1	%
450233	450232	15231	Alternator Bear. 1 Temperature (SPN1122)	1	°C
450234	450233	15232	Alternator Bear. 2 Temperature (SPN1123)	1	°C
450235	450234	15233	Alternator Wind. 1 Temperature (SPN1124)	1	°C
450236	450235	15234	Alternator Wind. 2 Temperature (SPN1125)	1	°C
450237	450236	15235	Alternator Wind. 3 Temperature (SPN1126)	1	°C
450238	450237	15236	Intake Manifold 2 Temperature (SPN1131)	1	°C
450239	450238	15237	Intake Manifold 3 Temperature (SPN1132)	1	°C
450240	450239	15238	Intake Manifold 4 Temperature (SPN1133)	1	°C
450241	450240	15239	Engine Intercooler Thermostat Opening (SPN1134)	0,1	%
450242	450241	15240	Engine Oil Temperature 2 (SPN1135)	0,1	°C
450243	450242	15241	Engine ECU Temperature (SPN1136)	0,1	°C
450244	450243	15242	Exhaust Gas Port 1 Temperatures (SPN1137)	0,1	°C
450245	450244	15243	Exhaust Gas Port 2 Temperatures (SPN1138)	0,1	°C
450246	450245	15244	Exhaust Gas Port 3 Temperatures (SPN1139)	0,1	°C
450247	450246	15245	Exhaust Gas Port 4 Temperatures (SPN1140)	0,1	°C
450248	450247	15246	Exhaust Gas Port 5 Temperatures (SPN1141)	0,1	°C
450249	450248	15247	Exhaust Gas Port 6 Temperatures (SPN1142)	0,1	°C

## Appendix

Data Protocols > Modbus > Protocol 5010 (Basic Visua...

Modbus		Parameter ID	Description	Multiplier	Units
Modicon start addr.	Start addr. (*1)				
450250	450249	15248	Exhaust Gas Port 7 Temperatures (SPN1143)	0,1	°C
450251	450250	15249	Exhaust Gas Port 8 Temperatures (SPN1144)	0,1	°C
450252	450251	15250	Exhaust Gas Port 9 Temperatures (SPN1145)	0,1	°C
450253	450252	15251	Exhaust Gas Port 10 Temperatures (SPN1146)	0,1	°C
450254	450253	15252	Exhaust Gas Port 11 Temperatures (SPN1147)	0,1	°C
450255	450254	15253	Exhaust Gas Port 12 Temperatures (SPN1148)	0,1	°C
450256	450255	15254	Exhaust Gas Port 13 Temperatures (SPN1149)	0,1	°C
450257	450256	15255	Exhaust Gas Port 14 Temperatures (SPN1150)	0,1	°C
450258	450257	15256	Exhaust Gas Port 15 Temperatures (SPN1151)	0,1	°C
450259	450258	15257	Exhaust Gas Port 16 Temperatures (SPN1152)	0,1	°C
450260	450259	15258	Exhaust Gas Port 17 Temperatures (SPN1153)	0,1	°C
450261	450260	15259	Exhaust Gas Port 18 Temperatures (SPN1154)	0,1	°C
450262	450261	15260	Exhaust Gas Port 19 Temperatures (SPN1155)	0,1	°C
450263	450262	15261	Exhaust Gas Port 20 Temperatures (SPN1156)	0,1	°C
450264	450263	15262	Main Bearing 1 Temperatures (SPN1157)	0,1	°C
450265	450264	15263	Main Bearing 2 Temperatures (SPN1158)	0,1	°C
450266	450265	15264	Main Bearing 3 Temperatures (SPN1159)	0,1	°C
450267	450266	15265	Main Bearing 4 Temperatures (SPN1160)	0,1	°C
450268	450267	15266	Main Bearing 5 Temperatures (SPN1161)	0,1	°C
450269	450268	15267	Main Bearing 6 Temperatures (SPN1162)	0,1	°C
450270	450269	15268	Main Bearing 7 Temperatures (SPN1163)	0,1	°C
450271	450270	15269	Main Bearing 8 Temperatures (SPN1164)	0,1	°C
450272	450271	15270	Main Bearing 9 Temperatures (SPN1165)	0,1	°C
450273	450272	15271	Main Bearing 10 Temperatures (SPN1166)	0,1	°C
450274	450273	15272	Main Bearing 11 Temperatures (SPN1167)	0,1	°C
450275	450274	15273	Turbo 1 Compressor Inlet Temperatures (SPN1172)	0,1	°C

Modbus		Parameter ID	Description	Multiplier	Units
Modicon start addr.	Start addr. (*1)				
450276	450275	15274	Turbo 2 Compressor Inlet Temperatures (SPN1173)	0,1	°C
450277	450276	15275	Turbo 3 Compressor Inlet Temperatures (SPN1174)	0,1	°C
450278	450277	15276	Turbo 4 Compressor Inlet Temperatures (SPN1175)	0,1	°C
450279	450278	15277	Turbo 1 Compressor Inlet Pressure (SPN1176)	1	kPa
450280	450279	15278	Turbo 2 Compressor Inlet Pressure (SPN1177)	1	kPa
450281	450280	15279	Turbo 3 Compressor Inlet Pressure (SPN1178)	1	kPa
450282	450281	15280	Turbo 4 Compressor Inlet Pressure (SPN1179)	1	kPa
450283	450282	15281	Turbo 1 Turbine Inlet Temperature (SPN1180)	0,1	°C
450284	450283	15282	Turbo 2 Turbine Inlet Temperature (SPN 1181)	0,1	°C
450285	450284	15283	Turbo 3 Turbine Inlet Temperature (SPN 1182)	0,1	°C
450286	450285	15284	Turbo 4 Turbine Inlet Temperature (SPN1183)	0,1	°C
450287	450286	15285	Turbo 1 Turbine Outlet Temperature (SPN1184)	0,1	°C
450288	450287	15286	Turbo 2 Turbine Outlet Temperature (SPN1185)	0,1	°C
450289	450288	15287	Turbo 3 Turbine Outlet Temperature (SPN 1186)	0,1	°C
450290	450289	15288	Turbo 4 Turbine Outlet Temperature (SPN1187)	0,1	°C
450291	450290	15289	Engine Aux. Coolant Pressure (SPN1203)	1	kPa
450292	450291	15290	Pre-filter Oil Pressure (SPN1208)	1	kPa
450293	450292	15291	Engine Aux. Coolant Temperature (SPN1212)	1	°C
450294	450293	15292	Fuel Filter Differential Pressure (SPN1382)	1	kPa
450295	450294	15293	Battery 1 Temperature (SPN1800)	1	°C
450296	450295	15294	Battery 2 Temperature (SPN1801)	1	°C
450297	450296	15295	Intake Manifold 5 Temperature (SPN1802)	1	°C
450298	450297	15296	Intake Manifold 6 Temperature (SPN1803)	1	°C
450299	450298	15297	Right Exhaust Gas Temperature (SPN2433)	0.1	°C
450300	450299	15298	Left Exhaust Gas Temperature (SPN2434)	0.1	°C

## Appendix

Data Protocols > Modbus > Protocol 5010 (Basic Visua...

Modbus		Parameter ID	Description	Multiplier	Units
Modicon start addr.	Start addr. (*1)				
450301	450300	15310	Engine Turbocharger 1 Compressor Outlet Temperature (SPN2629)	0.1	°C
450302	450301	15311	Engine Derate Request (SPN3644)	0.1	%
450303	450302	15312	Batterie Potential (SPN0158)	0.1	V
450304	450303	15313	Aftertreatment 1 Diesel Exhaust Fluid Tank 1 Level (SPN1761)	0.1	%
450305	450304	15314	Aftertreatment 1 Diesel Exhaust Fluid Tank 1 Temperature (SPN3031)	1	°C
450306	450305	15315	Aftertreatment 1 Diesel Exhaust Fluid Tank 2 Level (SPN4367)	0.1	%
450307	450306	15316	Aftertreatment 1 Diesel Exhaust Fluid Tank 2 Temperature (SPN4368)	1	°C
450308	450307		reserved		
450309	450308		reserved		
450310	450309		reserved		
450311	450310		reserved		
450312	450311		reserved		
450313	450312		reserved		
450314	450313		reserved		
450315	450314		reserved		
450316	450315		reserved		
450317	450316		reserved		
450318	450317		reserved		
450319	450318		reserved		
450320	450319		reserved		
450321	450320		reserved		
450322	450321		reserved		
<b>AC Generator And Busbar Values (Long - 32 bits)</b>					
450323	450322	135	Total gen. power	1	W
450325	450324	136	Total gen. reactive power	1	var
450327	450326	137	Total gen. apparent power	1	VA
450329	450328	170	Av. Gen. Wye-Voltage	0.1	V
450331	450330	171	Av. Gen. Delta-Voltage	0.1	V
450333	450332	216	Av. Busbar 1 Delta-Voltage	0.1	V
450335	450334	185	Av. Gen. Current	0.001	A
450337	450336	111	Gen. current 1	0.001	A
450339	450338	112	Gen. current 2	0.001	A

Modbus		Parameter ID	Description	Multiplier	Units
Modicon start addr.	Start addr. (*1)				
450341	450340	113	Gen. current 3	0.001	A
450343	450342	161	Meas. ground current	0.001	A
450345	450344	159	Calculated ground current	0.001	A
450347	450346	108	Gen. voltage L1-L2	0.1	V
450349	450348	109	Gen. voltage L2-L3	0.1	V
450351	450350	110	Gen. voltage L3-L1	0.1	V
450353	450352	114	Gen. voltage L1-N	0.1	V
450355	450354	115	Gen. voltage L2-N	0.1	V
450357	450356	116	Gen. voltage L3-N	0.1	V
450359	450358	125	Gen. active power 1-N	1	W
450361	450360	126	Gen. active power 2-N	1	W
450363	450362	127	Gen. active power 3-N	1	W
450365	450364	182	Busbar 1: voltage L1-L2	0.1	V
450367	450366	2520	Gen. real energy	0,01	MWh
450369	450368	2522	Gen. positive reactive energy	0,01	Mvarh
450371	450370	2568	Gen. hours of operation	0,01	h
450373	450372	5542	Setpoint active power	0,1	kW
450375	450374	5640	Setpoint voltage	1	V
450377	450376		reserved		
450379	450378		reserved		
450381	450380		reserved		
450383	450382		reserved		
<b>AC Mains Values (Long - 32 bits)</b>					
450385	450384	140	Total mains power	1	W
450387	450386	150	Total mains reactive power	1	var
450389	450388	173	Av. Mains Wye-Voltage	0.1	V
450391	450390	174	Av. Mains Delta-Voltage	0.1	V
450393	450392	207	Av. Mains Current	0.001	A
450395	450394	134	Mains current L1	0.001	A
450397	450396		reserved		
450399	450398		reserved		
450401	450400	118	Mains voltage L1-L2	0.1	V
450403	450402	119	Mains voltage L2-L3	0.1	V
450405	450404	120	Mains voltage L3-L1	0.1	V
450407	450406	121	Mains voltage L1-N	0.1	V

## Appendix

Data Protocols > Modbus > Protocol 5010 (Basic Visua...

Modbus		Parameter ID	Description	Multiplier	Units
Modicon start addr.	Start addr. (*1)				
450409	450408	122	Mains voltage L2-N	0.1	V
450411	450410	123	Mains voltage L3-N	0.1	V
<b>AC System Values (Long - 32 bits)</b>					
450413	450412	217	Reserve real power in system (only valid if LDSS is on)	1	kW
450415	450414	218	Real power in system (only valid if LDSS is on)	1	kW
450417	450416	219	Nominal real power in system (only valid if LDSS is on)	1	kW
450419	450418		reserved		
450421	450420		reserved		
450423	450422		reserved		
<b>Engine Management (Long - 32 bits)</b>					
<b>Active Diagnostic Trouble Code (DM1)</b>					
450425	450424	15400	SPN of 1. entry	full 19 bits of SPN	
450427	450426	15403	SPN of 2. entry	full 19 bits of SPN	
450429	450428	15406	SPN of 3. entry	full 19 bits of SPN	
450431	450430	15409	SPN of 4. entry	full 19 bits of SPN	
450433	450432	15412	SPN of 5. entry	full 19 bits of SPN	
450435	450434	15415	SPN of 6. entry	full 19 bits of SPN	
450437	450436	15419	SPN of 7. entry	full 19 bits of SPN	
450439	450438	15422	SPN of 8. entry	full 19 bits of SPN	
450441	450440	15425	SPN of 9. entry	full 19 bits of SPN	
450443	450442	15428	SPN of 10. entry	full 19 bits of SPN	
<b>Values</b>					
450445	450444	15201	Total engine hours (j1939-HOURS)	1	h
450447	450446		reserved		
450449	450448		reserved		
450451	450450		reserved		
450453	450452		reserved		
<b>LS5 (Long - 32 bits)</b>					
450455	450454		reserved		
450457	450456		reserved		
450459	450458		reserved		
450461	450460		reserved		

## 9.2.4 Additional Data Identifier

### 9.2.4.1 Transmit Data

#### Remote control word 1



#### **Object 21F7h (Parameter 503)**

*This object is required for remote control. The data type is UNSIGNED16.*

*The internal parameter 503 of the easYgen must be set to react on the remote control instructions. This is performed by sending rising signals for the respective bits (refer to Fig. 300 for the priority of start and stop signals).*

Parameter no.	Object ID	Name	Unit	Data type	Note
503	21F7h	Control word 1	Bit field	unsigned16	
		Bit 15	Not used		
		Bit 14	Not used		
		Bit 13	Not used		
		Bit 12	Not used		
		Bit 11	Not used		
		Bit 10	Not used		
		Bit 9	Shutdown command		To acknowledge, a 0 must be written and then a 1
		Bit 8	Not used		
		Bit 7	Not used		
		Bit 6	Not used		
		Bit 5	Not used		
		Bit 4	Ext. Acknowledge (rising edge) Must be set twice to acknowledge		To acknowledge, a 0 must be written and then a 1
		Bit 3	Must always be set to 0		
		Bit 2	Must always be set to 0		
		Bit 1	Stop bit (rising edge)		To stop, a 0 must be written and then a 1
		Bit 0	Start bit (rising edge)		To start, a 0 must be written and then a 1

Table 98: Remote control telegram

Bit 0 Start bit	With the rising edge of the bit, the easYgen activates the remote request command (LogicsManager input command variable 04.13).  The condition of the start command will be stored and may be used as command variable for the LogicsManager.
Bit 1 Stop bit	With the rising edge of the bit, the easYgen deactivates the remote request command (LogicsManager input command variable 04.13).  The condition of the start command will be stored and may be used as command variable for the LogicsManager.
Bit 4 "Reset alarms"	This bit controls the LogicsManager input command variable 04.14. The remote acknowledge bit must be set and reset twice to acknowledge an alarm completely. The first rising edge disables the horn and the second rising edge resets the alarm.
Bit 9 "Shutdown command"	This bit is directly influencing the LogicsManager command variable: "03.40 Remote Shutdown" and can be taken to create an engine shut down and/or an alarm over an internal flag.
Remote start /stop	The command variable "04.13 Remote request" changes to "1" (high) if the start bit is enabled and changes back to "0" (low) if the stop bit is enabled.
Ext. acknowledge	The command variable "04.14 Remote acknowledge" is the reflection of the control bit. The easYgen deactivates the horn with the first change from "0" to "1" of the logical output "External acknowledge", and acknowledges all alarm messages, which have occurred and are no longer active, with the second change from "0" to "1".

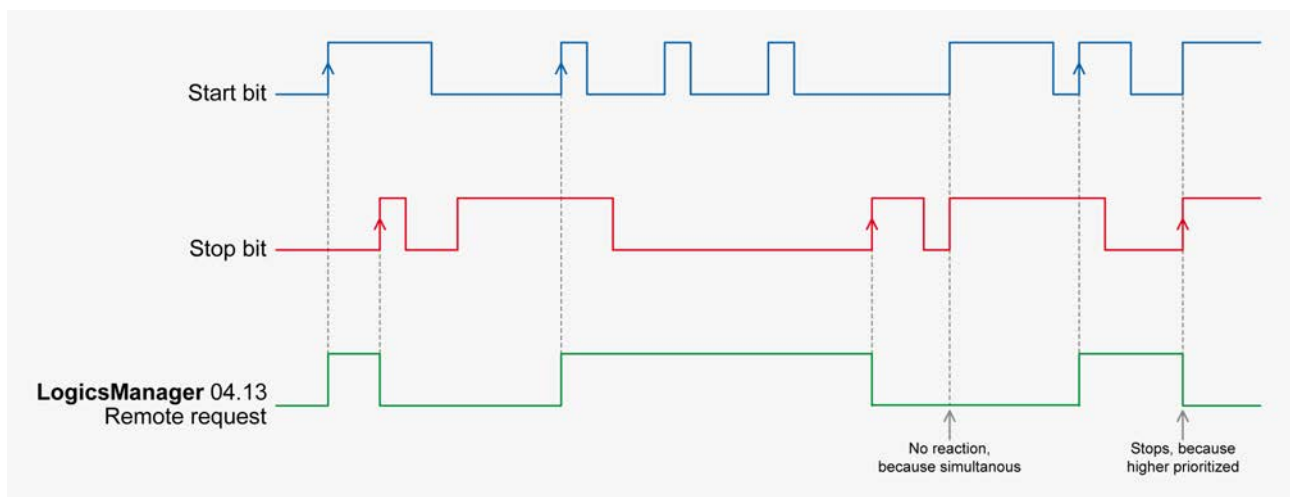

Fig. 300: : Remote control - start/stop priority

Fig. 300 shows the reaction of the command variable on the various status changes of the bits.



*The easYgen does **not** react on the disabling of the start bit, but only on the enabling of the stop bit. This has the advantage that it is not required to maintain the connection established for the whole time in case of a remote start via a modem.*



## Remote control word 2

**Object 21F8h (Parameter 504)**

*This object is required for remote control. The data type is UNSIGNED16.*

Bit 15 = 1	
Bit 14 = 1	
Bit 13 = 1	
Bit 12 = 1	
Bit 11 = 1	
Bit 10 = 1	
Bit 9 = 1	
Bit 8 = 1	
Bit 7 = 1	Request active power setpoint 2 – this bit activates the LogicsManager command variable [04.40] "Remote power setpoint 2" and is dedicated for switching from active power setpoint 1 to active power setpoint 2
Bit 6 = 1	Request power factor setpoint 2 – this bit activates the LogicsManager command variable [04.39] "Remote PF setpoint 2" and is dedicated for switching from power factor setpoint 1 to power factor setpoint 2
Bit 5 = 1	Request frequency setpoint 2 – this bit activates the LogicsManager command variable [04.38] "Remote frequency setpoint 2" and is dedicated for switching from frequency setpoint 1 to frequency setpoint 2
Bit 4 = 1	Request voltage setpoint 2 – this bit activates the LogicsManager command variable [04.37] "Remote voltage setpoint 2" and is dedicated for switching from voltage setpoint 1 to voltage setpoint 2
Bit 3 = 1	
Bit 2 = 1	
Bit 1 = 1	
Bit 0 = 1	

## Remote control word 3

**Object 21F9h (Parameter 505)**

*This object is required for remote control. These remote control bits can be used by a PLC to send control signals via SDO or PDO, which can then be used as command variables in the LogicsManager to control the easYgen. The data type is UNSIGNED16.*

Bit 15 = 1 (ID 541)	Remote control bit 16 (command variable 04.59)
Bit 14 = 1 (ID 542)	Remote control bit 15 (command variable 04.58)
Bit 13 = 1 (ID 543)	Remote control bit 14 (command variable 04.57)
Bit 12 = 1 (ID 544)	Remote control bit 13 (command variable 04.56)

Bit 11 = 1 (ID 545)	Remote control bit 12 (command variable 04.55)
Bit 10 = 1 (ID 546)	Remote control bit 11 (command variable 04.54)
Bit 9 = 1 (ID 547)	Remote control bit 10 (command variable 04.53)
Bit 8 = 1 (ID 548)	Remote control bit 9 (command variable 04.52)
Bit 7 = 1 (ID 549)	Remote control bit 8 (command variable 04.51)
Bit 6 = 1 (ID 550)	Remote control bit 7 (command variable 04.50)
Bit 5 = 1 (ID 551)	Remote control bit 6 (command variable 04.49)
Bit 4 = 1 (ID 552)	Remote control bit 5 (command variable 04.48)
Bit 3 = 1 (ID 553)	Remote control bit 4 (command variable 04.47)
Bit 2 = 1 (ID 554)	Remote control bit 3 (command variable 04.46)
Bit 1 = 1 (ID 555)	Remote control bit 2 (command variable 04.45)
Bit 0 = 1 (ID 556)	Remote control bit 1 (command variable 04.44)

**Remote active power setpoint**



**Object 21FBh (Parameter 507)**

*This value may be used as data source "[05.06] Interface pwr. setp." via the Analog Manager. No password is required to write this value.*

*This object is required to transmit the active power setpoint for active power control.*

*The data type is INTEGER32.*

*The value is scaled in [kW \* 10].*

*Example*

- 100 kW = 1000 = 03E8h

**Remote power factor setpoint**



**Object 21FCh (Parameter 508)**

*This value may be used as data source "[05.12] Interface PF setp." via the Analog Manager. No password is required to write this value.*

*This object is required to transmit the power factor setpoint for power factor control.*

*The data type is INTEGER16.*

*The valid range for this value is [-710 to 1000 to 710].*

*Example*

- PF (cosphi) = c0.71 (capacitive) = -710 = FD3Ah
  - PF (cosphi) = 1.00 = 1000 = 03E8h
  - PF (cosphi) = i0.71 (inductive) = 710 = 02C6h
- Remote Frequency Setpoint - Object 21FDh*

**Remote frequency setpoint****Object 21FDh (Parameter 509)**

*This value may be used as data source "[05.03] Interface freq. setp." via the Analog Manager. No password is required to write this value.*

*This object is required to transmit the frequency setpoint for frequency control.*

*The data type is INTEGER16.*

*The valid range for this value is [Hz \* 100].*

*Example*

*– 50.00 Hz = 5000 = 1388h*

**Remote voltage setpoint****Object 21FEh (Parameter 510)**

*This value may be used as data source "[05.09] Interface volt.setp." via the Analog Manager. No password is required to write this value.*

*This object is required to transmit the voltage setpoint for voltage control.*

*The data type is UNSIGNED32.*

*The value is scaled in [V].*

*Example*

*– 400 V = 400 = 190h*

*– 10000 V = 10000 = 2710h*

**External DI request (1 to 16)****Object 3F4Dh (Parameter 8014)**

*This object is required to receive the state of the external discrete inputs 1 to 16 (e.g. of a Phoenix expansion card). The data type is UNSIGNED16.*

Bit 15	External discrete input 16 [Dlex16]
Bit 14	External discrete input 15 [Dlex15]
Bit 13	External discrete input 14 [Dlex14]
Bit 12	External discrete input 13 [Dlex13]
Bit 11	External discrete input 12 [Dlex12]
Bit 10	External discrete input 11 [Dlex11]
Bit 9	External discrete input 10 [Dlex10]
Bit 8	External discrete input 9 [Dlex09]
Bit 7	External discrete input 8 [Dlex08]
Bit 6	External discrete input 7 [Dlex07]
Bit 5	External discrete input 6 [Dlex06]

Bit 4	External discrete input 5 [Dlex05]
Bit 3	External discrete input 4 [Dlex04]
Bit 2	External discrete input 3 [Dlex03]
Bit 1	External discrete input 2 [Dlex02]
Bit 0	External discrete input 1 [Dlex01]

**External DI request (17 to 32)**

 **P2**: applicable with package 2 only.



**Object 3F4Dh (Parameter 8015)**

*This object is required to receive the state of the external discrete inputs 17 to 32 (e.g. of a Phoenix expansion card). The data type is UNSIGNED16.*

Bit 15	External discrete input 32 [Dlex32]
Bit 14	External discrete input 31 [Dlex31]
Bit 13	External discrete input 30 [Dlex30]
Bit 12	External discrete input 29 [Dlex29]
Bit 11	External discrete input 28 [Dlex28]
Bit 10	External discrete input 27 [Dlex27]
Bit 9	External discrete input 26 [Dlex26]
Bit 8	External discrete input 25 [Dlex25]
Bit 7	External discrete input 24 [Dlex24]
Bit 6	External discrete input 23 [Dlex23]
Bit 5	External discrete input 22 [Dlex22]
Bit 4	External discrete input 21 [Dlex21]
Bit 3	External discrete input 20 [Dlex20]
Bit 2	External discrete input 19 [Dlex19]
Bit 1	External discrete input 18 [Dlex18]
Bit 0	External discrete input 17 [Dlex17]

**External Analog Inputs**

 **P2**: applicable with package 2 only.



**Object 4008h ff, Subindex 1 (Parameter 8200 ff)**

*This unscaled value is transmitted by the external expansion board. The easYgen must be configured to format this value accordingly. The data type is UNSIGNED16.*

The external analog inputs 1 to 16 have the following parameter IDs:

AI #	1	2	3	4	5	6	7	8
Object	4008	4009	400A	400B	400C	400D	400E	400F
ID	8200	8201	8202	8203	8204	8205	8206	8207

AI #	9	10	11	12	13	14	15	16
Object	4010	4011	4012	4013	4014	4015	4016	4017
ID	8208	8209	8210	8211	8212	8213	8214	8215

#### 9.2.4.2 Receive Data

##### External DO control (1 to 16)



##### **Object 34F5h (Parameter 8005)**

*This object is required to control the external outputs (relays) 1 to 16 (e.g. of a Phoenix expansion card). The data data type is UNSIGNED16.*

Bit 15	External discrete output 16 [Rex16]
Bit 14	External discrete output 15 [Rex15]
Bit 13	External discrete output 14 [Rex14]
Bit 12	External discrete output 13 [Rex13]
Bit 11	External discrete output 12 [Rex12]
Bit 10	External discrete output 11 [Rex11]
Bit 9	External discrete output 10 [Rex10]
Bit 8	External discrete output 9 [Rex09]
Bit 7	External discrete output 8 [Rex08]
Bit 6	External discrete output 7 [Rex07]
Bit 5	External discrete output 6 [Rex06]
Bit 4	External discrete output 5 [Rex05]
Bit 3	External discrete output 4 [Rex04]
Bit 2	External discrete output 3 [Rex03]
Bit 1	External discrete output 2 [Rex02]
Bit 0	External discrete output 1 [Rex01]

##### External DO control (17 to 32)

P2: applicable with package 2 only.



**Object 34F9h (Parameter 8009)**

*This object is required to control the external outputs (relays) 17 to 32 (e.g. of a Phoenix expansion card). The data type is UNSIGNED16.*

Bit 15	External discrete output 32 [Rex32]
Bit 14	External discrete output 31 [Rex31]
Bit 13	External discrete output 30 [Rex30]
Bit 12	External discrete output 29 [Rex29]
Bit 11	External discrete output 28 [Rex28]
Bit 10	External discrete output 27 [Rex27]
Bit 9	External discrete output 26 [Rex26]
Bit 8	External discrete output 25 [Rex25]
Bit 7	External discrete output 24 [Rex24]
Bit 6	External discrete output 23 [Rex23]
Bit 5	External discrete output 22 [Rex22]
Bit 4	External discrete output 21 [Rex21]
Bit 3	External discrete output 20 [Rex20]
Bit 2	External discrete output 19 [Rex19]
Bit 1	External discrete output 18 [Rex18]
Bit 0	External discrete output 17 [Rex17]

**External Analog Outputs**

P2: applicable with package 2 only.



**Object 4008h ff, Subindex 1 (Parameter ID 10246 ff)**

*This unscaled value is transmitted by the external expansion board. The easYgen must be configured to format this value accordingly. The data type is UNSIGNED16.*

The external analog outputs 1 to 4 have the following parameter IDs:

AI #	1	2	3	4
Object	4806hex	4810hex	481Ahex	4824hex
ID	10246	10256	10266	10276

## 9.3 Analog Manager Reference



For a description of the configuration parameters for the analog output refer to the [Chapter 4.5.7 “Analog Outputs” on page 254](#)

For a description of the configuration parameters for the flexible limits refer to [Chapter 4.4.5 “Flexible Limits” on page 194](#).

### 9.3.1 Data Sources

To enhance flexibility of programming the functions of the easYgen-3000 Series, an analog manager is used.

All analog values, which are delivered by the easYgen may be used as data sources for the analog outputs (refer to [Chapter 4.5.7 “Analog Outputs” on page 254](#)), the flexible limit monitoring (refer to [Chapter 4.4.5 “Flexible Limits” on page 194](#)), and the controller setpoints (refer to [Chapter 4.5.12 “Configure Controller” on page 300](#)).



- Every data source is indicated by a group number and a sub-number.
- Some values are percentage values and relate to reference values.

#### 9.3.1.1 Group 00: Internal Values

Analog input #	Data source	Reference value
00.01	Engine speed	Rated speed
00.02	Voltage bias	0 to 10000
00.03	Speed bias	0 to 10000
00.04	Battery voltage	Battery voltage 24 V
00.05	Analog input D+ (auxiliary excitation)	Battery voltage 24 V
00.06	Calculated ground current	Generator rated current
00.07	Measured ground current	Ground current transformer ratio setting (parameter 1810 <a href="#">p. 101</a> )
00.08	PID 1 bias	0 to 10000
00.09	PID 2 bias	0 to 10000
00.10	PID 3 bias	0 to 10000
00.11	System active nominal power	System rated active power (parameter 1825 <a href="#">p. 96</a> ), (own segment)

Analog input #	Data source	Reference value
00.12	System total real power	System rated active power (parameter 1825 ↗ p. 96), (own segment)
00.13	System reserve real power	System rated active power (parameter 1825 ↗ p. 96), (own segment)

**9.3.1.2 Group 01: Generator Values**

Analog input #	Data source	Reference value
01.01	Generator voltage wye average (phase-neutral)	Generator rated voltage
01.02	Generator voltage L1-N	Generator rated voltage
01.03	Generator voltage L2-N	Generator rated voltage
01.04	Generator voltage L3-N	Generator rated voltage
01.05	Generator voltage delta average (phase-phase)	Generator rated voltage
01.06	Generator voltage L1-L2	Generator rated voltage
01.07	Generator voltage L2-L3	Generator rated voltage
01.08	Generator voltage L3-L1	Generator rated voltage
01.09	Generator frequency	Rated frequency
01.10	Generator frequency L1-L2	Rated frequency
01.11	Generator frequency L2-L3	Rated frequency
01.12	Generator frequency L3-L1	Rated frequency
01.13	Generator current average	Generator rated current
01.14	Generator current L1	Generator rated current
01.15	Generator current L2	Generator rated current
01.16	Generator current L3	Generator rated current
01.17	Generator maximum current L1	Generator rated current
01.18	Generator maximum current L2	Generator rated current
01.19	Generator maximum current L3	Generator rated current
01.20	Generator power factor	Power factor 1
01.21	Generator power factor L1	Power factor 1
01.22	Generator power factor L2	Power factor 1
01.23	Generator power factor L3	Power factor 1
01.24	Generator total real power	Generator rated real power
01.25	Generator real power L1-N	Generator rated real power
01.26	Generator real power L2-N	Generator rated real power
01.27	Generator real power L3-N	Generator rated real power
01.28	Generator total reactive power	Generator rated reactive power
01.29	Generator reactive power L1-N	Generator rated reactive power



Analog input #	Data source	Reference value
01.30	Generator reactive power L2-N	Generator rated reactive power
01.31	Generator reactive power L3-N	Generator rated reactive power
01.32	Generator total apparent power	Generator rated real and reactive power
01.33	Generator apparent power L1-N	Generator rated real and reactive power
01.34	Generator apparent power L2-N	Generator rated real and reactive power
01.35	Generator apparent power L3-N	Generator rated real and reactive power

### 9.3.1.3 Group 02: Mains Values

Analog input #	Data source	Reference value
02.01	Mains voltage wye average (phase-neutral)	Mains rated voltage
02.02	Mains voltage L1-N	Mains rated voltage
02.03	Mains voltage L2-N	Mains rated voltage
02.04	Mains voltage L3-N	Mains rated voltage
02.05	Mains voltage delta average (phase-phase)	Mains rated voltage
02.06	Mains voltage L1-L2	Mains rated voltage
02.07	Mains voltage L2-L3	Mains rated voltage
02.08	Mains voltage L3-L1	Mains rated voltage
02.09	Mains frequency	Rated frequency
02.10	Mains frequency L1-L2	Rated frequency
02.11	Mains frequency L2-L3	Rated frequency
02.12	Mains frequency L3-L1	Rated frequency
02.13	Mains current average	Mains rated current
02.14	Mains current L1	Mains rated current
02.17	Maximum mains current L1	Mains rated current
02.20	Mains power factor	Power factor 1
02.21	Mains power factor L1	Power factor 1
02.24	Mains total power	Mains rated real power
02.25	Mains power L1-N	Mains rated real power
02.28	Mains total reactive power	Mains rated reactive power
02.29	Mains reactive power L1-N	Mains rated reactive power
02.32	Mains total apparent power	Mains rated real and reactive power
02.33	Mains apparent power L1-N	Mains rated real and reactive power
02.36	External mains active power	Mains rated active power
02.37	External mains reactive power	Mains rated reactive power
02.38	External mains power factor	Power factor 1

**9.3.1.4 Group 03: Busbar 1 Values**



Analog input #	Data source	Reference value
03.01	Busbar 1 average voltage	Busbar 1 rated voltage
03.02	Busbar 1 voltage L1-L2	Busbar 1 rated voltage
03.05	Busbar 1 frequency	Rated frequency
03.06	Busbar 1 frequency L1-L2	Rated frequency

**9.3.1.5 Group 05: Controller Setpoints**

Analog input #	Data source	Reference value
05.01	Internal frequency setpoint 1	
05.02	Internal frequency setpoint 2	
05.03	Interface frequency setpoint	
05.04	Internal power setpoint 1	
05.05	Internal power setpoint 2	
05.06	Interface power setpoint	
05.07	Internal voltage setpoint 1	
05.08	Internal voltage setpoint 2	
05.09	Interface voltage setpoint	
05.10	Internal power factor setpoint 1	
05.11	Internal power factor setpoint 2	
05.12	Interface power factor setpoint	
05.13	Discrete f +/-	
05.14	Discrete P +/-	
05.15	Discrete V +/-	
05.16	Discrete PF +/-	
05.17	Used frequency setpoint	
05.18	Used frequency setpoint ramp	
05.19	Used power setpoint	
05.20	Used power setpoint ramp	
05.21	Used voltage setpoint	
05.22	Used voltage setpoint ramp	
05.23	Used PF setpoint	
05.24	Used PF setpoint ramp	
05.25	Internal PID 1 setpoint	
05.26	Internal PID 1 setpoint	
05.27	Internal PID 1 setpoint	

Analog input #	Data source	Reference value
05.28	f dependent derating power	
05.29	PF characteristic	
05.30	Internal pwr. setp.3	Internal power setpoint 3

### 9.3.1.6 Group 06: DC Analog Input Values

Analog input #	Data source	Reference value
06.01	Analog input 1	Display value format (  "Display value format" on page 675)
06.02	Analog input 2	Display value format (  "Display value format" on page 675)
06.03	Analog input 3	Display value format (  "Display value format" on page 675)

If the analog input type (parameter 1000  p. 237) is configured to VDO or Pt100, the following display value formats apply:

Analog input type	Display value format	Example value	Example format
VDO 5 bar	0.01 bar	5.0 bar	500
VDO 10 bar	0.01 bar	6.6 bar	660
VDO 120°C	1 °C	69 °C	69
VDO 150°C	1 °C	73 °C	73
Pt100	1 °C	103 °C	103

Table 99: Display value format

### 9.3.1.7 Group 07: Engine Values 1 (J1939)

Analog input #	Data source	Reference value
07.01	SPN 52: Engine Intercooler	
07.02	SPN 91: Throttle Position	
07.03	SPN 92: Load At Current Speed	
07.04	SPN 94: Fuel Delivery Pressure	
07.05	SPN 95: Fuel Filter Difference Pressure	
07.06	SPN 98: Engine Oil Level	
07.07	SPN 100: Engine Oil Pressure	
07.08	SPN 101: Crankcase Pressure	
07.09	SPN 102: Boost Pressure	
07.10	SPN 105: Intake Manifold 1 Temperature	

## Appendix

Analog Manager Reference > Data Sources > Group 07: Engine Values 1 ...









Analog input #	Data source	Reference value
07.11	SPN 106: Turbo Air Inlet Pressure	
07.12	SPN 107: Air Filter 1 Difference Pressure	
07.13	SPN 108: Barometric Pressure	
07.14	SPN 109: Coolant Pressure	
07.15	SPN 110: Engine Coolant Temperature	
07.16	SPN 111: Coolant Level	
07.17	SPN 127: Transmission Oil Pressure	
07.18	SPN 157: Fuel Rail Pressure	
07.19	SPN 171: Ambient Air Temperature	
07.20	SPN 172: Air Inlet Temperature	
07.21	SPN 173: Exhaust Gas Temperature	
07.22	SPN 174: Fuel Temperature	
07.23	SPN 175: Engine Oil Temperature 1	
07.24	SPN 176: Turbo Oil Temperature	
07.25	SPN 177: Transmission Oil Temperature	
07.26	SPN 183: Fuel Rate	
07.27	SPN 190: Engine Speed	
07.28	SPN 441: Auxiliary Temperature 1	
07.29	SPN 442: Auxiliary Temperature 2	
07.30	SPN 513: Actual Engine Torque	
07.31	SPN 1122: Alternator Bearing 1 Temperature	
07.32	SPN 1123: Alternator Bearing 2 Temperature	
07.33	SPN 1124: Alternator Winding 1 Temperature	
07.34	SPN 1125: Alternator Winding 2 Temperature	
07.35	SPN 1126: Alternator Winding 3 Temperature	
07.36	SPN 1131: Intake Manifold 2 Temperature	
07.37	SPN 1132: Intake Manifold 3 Temperature	
07.38	SPN 1133: Intake Manifold 4 Temperature	
07.39	SPN 1134: Engine Thermostat	
07.40	SPN 1135: Engine Oil Temperature 2	
07.41	SPN 1136: Engine ECU Temperature	
07.42	SPN 1137: Exhaust Gas Port 1 Temperature	
07.43	SPN 1138: Exhaust Gas Port 2 Temperature	
07.44	SPN 1139: Exhaust Gas Port 3 Temperature	
07.45	SPN 1140: Exhaust Gas Port 4 Temperature	
07.46	SPN 1141: Exhaust Gas Port 5 Temperature	
07.47	SPN 1142: Exhaust Gas Port 6 Temperature	

Analog input #	Data source	Reference value
07.48	SPN 1143: Exhaust Gas Port 7 Temperature	
07.49	SPN 1144: Exhaust Gas Port 8 Temperature	
07.50	SPN 1145: Exhaust Gas Port 9 Temperature	
07.51	SPN 1146: Exhaust Gas Port 10 Temperature	
07.52	SPN 1147: Exhaust Gas Port 11 Temperature	
07.53	SPN 1148: Exhaust Gas Port 12 Temperature	
07.54	SPN 1149: Exhaust Gas Port 13 Temperature	
07.55	SPN 1150: Exhaust Gas Port 14 Temperature	
07.56	SPN 1151: Exhaust Gas Port 15 Temperature	
07.57	SPN 1152: Exhaust Gas Port 16 Temperature	
07.58	SPN 1153: Exhaust Gas Port 17 Temperature	
07.59	SPN 1154: Exhaust Gas Port 18 Temperature	
07.60	SPN 1155: Exhaust Gas Port 19 Temperature	
07.61	SPN 1156: Exhaust Gas Port 20 Temperature	
07.62	SPN 1157: Main Bearing 1 Temperature	
07.63	SPN 1158: Main Bearing 2 Temperature	
07.64	SPN 1159: Main Bearing 3 Temperature	
07.65	SPN 1160: Main Bearing 4 Temperature	
07.66	SPN 1161: Main Bearing 5 Temperature	
07.67	SPN 1162: Main Bearing 6 Temperature	
07.68	SPN 1163: Main Bearing 7 Temperature	
07.69	SPN 1164: Main Bearing 8 Temperature	
07.70	SPN 1165: Main Bearing 9 Temperature	
07.71	SPN 1166: Main Bearing 10 Temperature	
07.72	SPN 1167: Main Bearing 11 Temperature	
07.73	SPN 1172: Turbo 1 Compressor Inlet Temperature	
07.74	SPN 1173: Turbo 2 Compressor Inlet Temperature	
07.75	SPN 1174: Turbo 3 Compressor Inlet Temperature	
07.76	SPN 1175: Turbo 4 Compressor Inlet Temperature	
07.77	SPN 1176: Turbo 1 Compressor Inlet pressure	
07.78	SPN 1177: Turbo 2 Compressor Inlet pressure	
07.79	SPN 1178: Turbo 3 Compressor Inlet pressure	
07.80	SPN 1179: Turbo 4 Compressor Inlet pressure	
07.81	SPN 1180: Turbo 1 Inlet Temperature	
07.82	SPN 1181: Turbo 2 Inlet Temperature	
07.83	SPN 1182: Turbo 3 Inlet Temperature	
07.84	SPN 1183: Turbo 4 Inlet Temperature	

Analog input #	Data source	Reference value
07.85	SPN 1184: Turbo 1 Outlet Temperature	
07.86	SPN 1185: Turbo 2 Outlet Temperature	
07.87	SPN 1186: Turbo 3 Outlet Temperature	
07.88	SPN 1187: Turbo 4 Outlet Temperature	
07.89	SPN 1203: Engine Auxiliary Coolant Pressure	
07.90	SPN 1208: Pre-Filter Oil Pressure	
07.91	SPN 1212: Engine Auxiliary Coolant Temperature	
07.92	SPN 1382: Fuel Filter Difference Pressure	
07.93	SPN 1800: Battery 1 Temperature	
07.94	SPN 1801: Battery 2 Temperature	
07.95	SPN 1802: Intake Manifold 5 Temperature	
07.96	SPN 1803: Intake Manifold 6 Temperature	
07.97	SPN 2433: Right Exhaust Gas Temperature	
07.98	SPN 2434: Left Exhaust Gas Temperature	
07.99	SPN 2629: Turbo 1 Compressor Outlet Temperature	

**9.3.1.8 Group 08: External Analog Input Values**

 **P2**: the following External AI's are applicable with package 2 only

Analog input #	Data source	Reference value
08.01	Ext. analog input 1	Display value format (  "Display value format" on page 675)
08.02	Ext. analog input 2	Display value format (  "Display value format" on page 675)
08.03	Ext. analog input 3	Display value format (  "Display value format" on page 675)
08.04	Ext. analog input 4	Display value format (  "Display value format" on page 675)
08.05	Ext. analog input 5	Display value format (  "Display value format" on page 675)
08.06	Ext. analog input 6	Display value format (  "Display value format" on page 675)
08.07	Ext. analog input 7	Display value format (  "Display value format" on page 675)
08.08	Ext. analog input 8	Display value format (  "Display value format" on page 675)
08.09	Ext. analog input 9	Display value format (  "Display value format" on page 675)

Analog input #	Data source	Reference value
08.10	Ext. analog input 10	Display value format ( <a href="#">↪ "Display value format" on page 675</a> )
08.11	Ext. analog input 11	Display value format ( <a href="#">↪ "Display value format" on page 675</a> )
08.12	Ext. analog input 12	Display value format ( <a href="#">↪ "Display value format" on page 675</a> )
08.13	Ext. analog input 13	Display value format ( <a href="#">↪ "Display value format" on page 675</a> )
08.14	Ext. analog input 14	Display value format ( <a href="#">↪ "Display value format" on page 675</a> )
08.15	Ext. analog input 15	Display value format ( <a href="#">↪ "Display value format" on page 675</a> )
08.16	Ext. analog input 16	Display value format ( <a href="#">↪ "Display value format" on page 675</a> )

### 9.3.1.9 Group 09: Engine Values 2 (J1939)

Analog input #	Data source	Reference value
09.01	SPN 3644: Engine Derate Request	Gen. rated active power [kW] (parameter 1752 <a href="#">↪ p. 95</a> )
09.02	SPN 0158: Battery Potential Switched	Battery voltage 24 V
09.08	SPN 1761: Aftertr.1 Exh.Tank1 Lev.	
09.09	SPN 3031: Aftertr.1 Exh.Tank1 Temp.	
09.10	SPN 4367: Aftertr.1 Exh.Tank2 Lev.	
09.11	SPN 4368: Aftertr.1 Exh.Tank2 Temp.	

## 9.3.2 Reference Values

### 9.3.2.1 Generator Rated Voltage

All generator voltage values (wye, delta, and average values) refer to the generator rated voltage (parameter 1766 [↪ p. 95](#)).

**Analog output example**

- The generator rated voltage (parameter 1766 ↪ p. 95) is configured to 400 V.
- The source value at maximum output is configured to 110.00 % (of the rated voltage i.e. 440 V).
- The source value at minimum output is configured to 10.00 % (of the rated voltage i.e. 40 V).
- The analog output range is configured to 0 to 20 mA.
- If a generator voltage of 40 V (or below) is measured, the analog output issues its lower limit (i.e. 0 mA).
- If a generator voltage of 440 V (or above) is measured, the analog output issues its upper limit (i.e. 20 mA).
- If a generator voltage of 240 V is measured, the analog output issues 50 % of its upper limit (i.e. 10 mA).
- If a generator voltage of 400 V is measured, the analog output issues 90 % of its upper limit (i.e. 18 mA).

**Flexible limit example**

- The generator rated voltage (parameter 1766 ↪ p. 95) is configured to 400 V.
- If the flexible limit is to be configured to 110.00 % (of the rated voltage i.e. 440 V), it must be entered as 11000.

**9.3.2.2 Mains Rated Voltage**

All mains voltage values (wye, delta, average, and peak values) refer to the mains rated voltage (parameter 1768 ↪ p. 95).

**Analog output example**

- The mains rated voltage (parameter 1768 ↪ p. 95) is configured to 400 V.
- The source value at maximum output is configured to 110.00 % (of the rated voltage i.e. 440 V).
- The source value at minimum output is configured to 10.00 % (of the rated voltage i.e. 40 V).
- The analog output range is configured to 0 to 20 mA.
- If a mains voltage of 40 V (or below) is measured, the analog output issues its lower limit (i.e. 0 mA).
- If a mains voltage of 440 V (or above) is measured, the analog output issues its upper limit (i.e. 20 mA).
- If a mains voltage of 240 V is measured, the analog output issues 50 % of its upper limit (i.e. 10 mA).
- If a mains voltage of 400 V is measured, the analog output issues 90 % of its upper limit (i.e. 18 mA).

**Flexible limit example**

- The mains rated voltage (parameter 1768 ↪ p. 95) is configured to 400 V.
- If the flexible limit is to be configured to 110.00 % (of the rated voltage i.e. 440 V), it must be entered as 11000.

**9.3.2.3 Rated Frequency**

All frequency values (generator, mains, busbar 1) refer to the rated system frequency (parameter 1750 ↪ p. 95).



**Analog output example**

- The rated system frequency (parameter 1750 ↵ p. 95) is configured to 50 Hz.
- The source value at maximum output is configured to 110.00 % (of the rated frequency i.e. 55 Hz).
- The source value at minimum output is configured to 90.00 % (of the rated frequency i.e. 45 Hz).
- The analog output range is configured to 0 to 20 mA.
- If a frequency of 45 Hz (or below) is measured, the analog output issues its lower limit (i.e. 0 mA).
- If a frequency of 55 Hz (or above) is measured, the analog output issues its upper limit (i.e. 20 mA).
- If a frequency of 50 Hz is measured, the analog output issues 50 % of its upper limit (i.e. 10 mA).
- If a frequency of 51 Hz is measured, the analog output issues 60 % of its upper limit (i.e. 12 mA).

**Flexible limit example**

- The rated system frequency (parameter 1750 ↵ p. 95) is configured to 50 Hz.
- If the flexible limit is to be configured to 105.00 % (of the rated frequency i.e. 52.5 Hz), it must be entered as 10500.

**9.3.2.4 Generator Rated Active Power**

All generator active power values refer to the generator rated active power (parameter 1752 ↵ p. 95).

**Analog output example**

- The generator rated active power (parameter 1752 ↵ p. 95) is configured to 500 kW.
- The source value at maximum output is configured to 120.00 % (of the rated active power i.e. 600 kW).
- The source value at minimum output is configured to 0.00 % (of the rated active power i.e. 0 kW).
- The analog output range is configured to 0 to 20 mA.
- If an active power of 0 kW is measured, the analog output issues its lower limit (i.e. 0 mA).
- If an active power of 600 kW (or above) is measured, the analog output issues its upper limit (i.e. 20 mA).
- If an active power of 300 kW is measured, the analog output issues 50 % of its upper limit (i.e. 10 mA).
- If an active power of 120 kW is measured, the analog output issues 20 % of its upper limit (i.e. 4 mA).

**Flexible limit example**

- The generator rated active power (parameter 1752 ↵ p. 95) is configured to 500 kW.
- If the flexible limit is to be configured to 120.00 % (of the rated active power i.e. 600 kW), it must be entered as 12000.

**9.3.2.5 Generator Rated Reactive Power**

All generator reactive power values refer to the generator rated reactive power (parameter 1758 ↵ p. 95).

**Analog output example**

- The generator rated reactive power (parameter 1758 ↪ p. 95) is configured to 500 kvar.
- The source value at maximum output is configured to 120.00 % (of the rated reactive power i.e. 600 kvar).
- The source value at minimum output is configured to 0.00 % (of the rated reactive power i.e. 0 kvar).
- The analog output range is configured to 0 to 20 mA.
- If a reactive power of 0 kvar is measured, the analog output issues its lower limit (i.e. 0 mA).
- If a reactive power of 600 kvar (or above) is measured, the analog output issues its upper limit (i.e. 20 mA).
- If a reactive power of 300 kvar is measured, the analog output issues 50 % of its upper limit (i.e. 10 mA).
- If a reactive power of 120 kvar is measured, the analog output issues 20 % of its upper limit (i.e. 4 mA).

**Flexible limit example**

- The generator rated reactive power (parameter 1758 ↪ p. 95) is configured to 500 kvar.
- If the flexible limit is to be configured to 120.00 % (of the rated reactive power i.e. 600 kvar), it must be entered as 12000.



*The above example is valid for inductive/lagging power. If capacitive/leading power is to be output, the settings for the source value at min/max output must be negative.*

**9.3.2.6 Mains Rated Voltage**

All mains active power values refer to the mains rated active power (parameter 1748 ↪ p. 95).

**Analog output example**

- The mains rated active power (parameter 1748 ↪ p. 95) is configured to 500 kW.
- The source value at maximum output is configured to 120.00% (of the rated active power i.e. 600 kW).
- The source value at minimum output is configured to 0.00% (of the rated active power i.e. 0 kW)
- The analog output range is configured to 0 to 20 mA.
- If a real power of 0 kW is measured, the analog output issues its lower limit (i.e. 0 mA).
- If a real power of 600 kW (or above) is measured, the analog output issues its upper limit (i.e. 20 mA).
- If a real power of 300 kW is measured, the analog output issues 50 % of its upper limit (i.e. 10 mA).
- If a real power of 120 kW is measured, the analog output issues 20 % of its upper limit (i.e. 4 mA).

**Flexible limit example**

- The mains rated active power (parameter 1748 ↗ p. 95) is configured to 500 kW.
- If the flexible limit is to be configured to 120.00% (of the rated active power i.e. 600 kW), it must be entered as 12000.

**9.3.2.7 Mains Rated Reactive Power**

All mains reactive power values refer to the mains rated reactive power (parameter 1746 ↗ p. 96).

**Analog output example**

- The mains rated reactive power (parameter 1746 ↗ p. 96) is configured to 500 kvar.
- The source value at maximum output is configured to 120.00 % (of the rated reactive power i.e. 600 kvar).
- The source value at minimum output is configured to 0.00 % (of the rated reactive power i.e. 0 kvar).
- The analog output range is configured to 0 to 20 mA.
- If a reactive power of 0 kvar is measured, the analog output issues its lower limit (i.e. 0 mA).
- If a reactive power of 600 kvar (or above) is measured, the analog output issues its upper limit (i.e. 20 mA).
- If a reactive power of 300 kvar is measured, the analog output issues 50 % of its upper limit (i.e. 10 mA).
- If a reactive power of 120 kvar is measured, the analog output issues 20 % of its upper limit (i.e. 4 mA).

**Flexible limit example**

- The mains rated reactive power (parameter 1746 ↗ p. 96) is configured to 500 kvar.
- If the flexible limit is to be configured to 120.00 % (of the rated reactive power i.e. 600 kvar), it must be entered as 12000.

**9.3.2.8 Generator Rated Apparent Power**

All generator apparent power values refer to the generator rated active power (parameter 1752 ↗ p. 95) and generator rated reactive power (parameter 1758 ↗ p. 95).

The generator rated apparent power S is calculated using the real power P and the reactive power Q according to this formula:

- $S = \sqrt{P^2 + Q^2}$

**Analog output example**

- The generator rated active power (parameter 1752 ↗ p. 95) is configured to 200 kW.
- The generator rated reactive power (parameter 1758 ↗ p. 95) is configured to 200 kvar.
- The generator rated apparent power is:  
 $S = \sqrt{(200^2 + 200^2)} = 282.84 \text{ kVA}$ .
- The source value at maximum output is configured to 120.00% (of the rated apparent power i.e. 339.41 kVA).
- The source value at minimum output is configured to 0.00% (of the rated apparent power i.e. 0 kVA).
- The analog output range is configured to 0 to 20 mA.
- If an apparent power of 0 kVA is measured, the analog output issues its lower limit (i.e. 0 mA).
- If an apparent power of 339.41 kVA (or above) is measured, the analog output issues its upper limit (i.e. 20 mA).
- If an apparent power of 169.71 kVA is measured, the analog output issues 50 % of its upper limit (i.e. 10 mA).
- If an apparent power of 67.88 kVA is measured, the analog output issues 20 % of its upper limit (i.e. 4 mA).

**Flexible limit example**

- The generator rated active power (parameter 1752 ↗ p. 95) is configured to 200 kW.
- The generator rated reactive power (parameter 1758 ↗ p. 95) is configured to 200 kvar.
- The generator rated apparent power is:  
 $S = \sqrt{(200^2 + 200^2)} = 282.84 \text{ kVA}$ .
- If the flexible limit is to be configured to 120.00% (of the rated apparent power i.e. 339.41 kVA), it must be entered as 12000.

**9.3.2.9 Mains Rated Apparent Power**

All mains apparent power values refer to the mains rated active power (parameter 1748 ↗ p. 95) and mains rated reactive power (parameter 1746 ↗ p. 96).

The mains rated apparent power  $S$  is calculated using the real power  $P$  and the reactive power  $Q$  according to this formula:

- $S = \sqrt{(P^2 + Q^2)}$

**Analog output example**

- The mains rated active power (parameter 1748 ↗ p. 95) is configured to 200 kW.
- The mains rated reactive power (parameter 1746 ↗ p. 96) is configured to 200 kvar.
- The mains rated apparent power is:  
 $S = \sqrt{(200^2 + 200^2)} = 282.84 \text{ kVA}$ .
- The source value at maximum output is configured to 120.00 % (of the rated apparent power i.e. 339.41 kVA).
- The source value at minimum output is configured to 0.00 % (of the rated apparent power i.e. 0 kVA).
- The analog output range is configured to 0 to 20 mA.
- If an apparent power of 0 kVA is measured, the analog output issues its lower limit (i.e. 0 mA).
- If an apparent power of 339.41 kVA (or above) is measured, the analog output issues its upper limit (i.e. 20 mA).
- If an apparent power of 169.71 kVA is measured, the analog output issues 50 % of its upper limit (i.e. 10 mA).
- If an apparent power of 67.88 kVA is measured, the analog output issues 20 % of its upper limit (i.e. 4 mA).

**Flexible limit example**

- The mains rated active power (parameter 1748 ↗ p. 95) is configured to 200 kW.
- The mains rated reactive power (parameter 1746 ↗ p. 96) is configured to 200 kvar.
- The mains rated apparent power is:  
 $S = \sqrt{(200^2 + 200^2)} = 282.84 \text{ kVA}$ .
- If the flexible limit is to be configured to 120.00 % (of the rated apparent power i.e. 339.41 kVA), it must be entered as 12000.

**9.3.2.10 Generator / Mains Power Factor**

The power factor is scaled linear over a range from 0001 to 9999 according to the following:

- Power factor leading 0.01 corresponds with a value of 0001 (i.e. 00.01 % of the value range).
- Power factor leading 0.50 corresponds with a value of 2500 (i.e. 25.00 % of the value range).
- Power factor leading 0.80 corresponds with a value of 4000 (i.e. 40.00 % of the value range).
- Power factor 1.00 corresponds with a value of 5000 (i.e. 50.00 % of the value range).
- Power factor lagging 0.80 corresponds with a value of 6000 (i.e. 60.00 % of the value range).
- Power factor lagging 0.50 corresponds with a value of 7500 (i.e. 75.00 % of the value range).
- Power factor lagging 0.01 corresponds with a value of 9999 (i.e. 99.99 % of the value range).

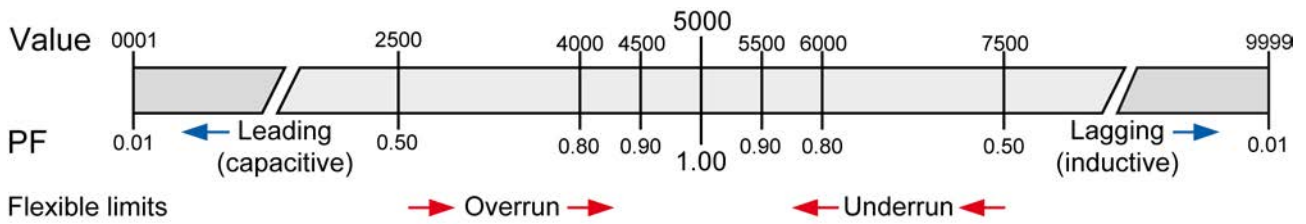

Fig. 301: Power factor scaling

**Analog output example**

- The source value at maximum output is configured to 10000.
- The source value at minimum output is configured to 00000.
- The analog output range is configured to 0 to 20 mA.
- If a power factor of leading 0.8 is measured, the analog output issues 40 % of its upper limit (i.e. 8 mA).
- If a power factor of leading 1 is measured, the analog output issues 50 % of its upper limit (i.e. 10 mA).
- If a power factor of lagging 0.9 is measured, the analog output issues 55 % of its upper limit (i.e. 11 mA).

**Flexible limit example**

- If a power factor of leading 0.95 is measured, the issued value is 4750.
- If a power factor of leading 1 is measured, the issued value is 5000.
- If a power factor of lagging 0.8 is measured, the issued value is 6000.

**9.3.2.11 Generator Rated Current**

All generator current values (line, average, and peak values) refer to the generator rated current (parameter 1754 ↪ p. 95).

**Analog output example**

- The generator rated current (parameter 1754 ↪ p. 95) is configured to 1000 A.
- The source value at maximum output is configured to 110.00 % (of the rated current i.e. 1100 A).
- The source value at minimum output is configured to 10.00 % (of the rated current i.e. 100 A).
- The analog output range is configured to 0 to 20 mA.
- If a generator current of 100 A (or below) is measured, the analog output issues its lower limit (i.e. 0 mA).
- If a generator current of 1100 A (or above) is measured, the analog output issues its upper limit (i.e. 20 mA).
- If a generator current of 600 A is measured, the analog output issues 50 % of its upper limit (i.e. 10 mA).
- If a generator current of 300 A is measured, the analog output issues 20 % of its upper limit (i.e. 4 mA).

**Flexible limit example**

- The generator rated current (parameter 1754 ↪ p. 95) is configured to 1000 A.
- If the flexible limit is to be configured to 110.00 % (of the rated current i.e. 1100 A), it must be entered as 11000.

### 9.3.2.12 Mains Rated Current

All mains current values (line, average, and peak values) refer to the mains rated current (parameter 1785 ↗ p. 96).

#### Analog output example

- The mains rated current (parameter 1785 ↗ p. 96) is configured to 1000 A.
- The source value at maximum output is configured to 110.00 % (of the rated current i.e. 1100 A).
- The source value at minimum output is configured to 10.00 % (of the rated current i.e. 100 A).
- The analog output range is configured to 0 to 20 mA.
- If a mains current of 100 A (or below) is measured, the analog output issues its lower limit (i.e. 0 mA).
- If a mains current of 1100 A (or above) is measured, the analog output issues its upper limit (i.e. 20 mA).
- If a mains current of 600 A is measured, the analog output issues 50 % of its upper limit (i.e. 10 mA).
- If a mains current of 300 A is measured, the analog output issues 20 % of its upper limit (i.e. 4 mA).

#### Flexible limit example

- The mains rated current (parameter 1785 ↗ p. 96) is configured to 1000 A.
- If the flexible limit is to be configured to 110.00 % (of the rated current i.e. 1100 A), it must be entered as 11000.

### 9.3.2.13 Rated Speed

The measured speed refers to the rated speed (parameter 1601 ↗ p. 95).

#### Analog output example

- The rated speed (parameter 1601 ↗ p. 95) is configured to 1500 rpm.
- The source value at maximum output is configured to 120.00 % (of the rated speed i.e. 1800 rpm).
- The source value at minimum output is configured to 0.00 % (of the rated speed i.e. 0 rpm).
- The analog output range is configured to 0 to 20 mA.
- If a speed of 0 rpm is measured, the analog output issues its lower limit (i.e. 0 mA).
- If a speed of 1800 rpm (or above) is measured, the analog output issues its upper limit (i.e. 20 mA).
- If a speed of 900 rpm is measured, the analog output issues 50 % of its upper limit (i.e. 10 mA).
- If a speed of 1500 rpm is measured, the analog output issues ~83 % of its upper limit (i.e. 16.7 mA).

#### Flexible limit example

- The rated speed (parameter 1601 ↗ p. 95) is configured to 1500 rpm.
- If the flexible limit is to be configured to 120.00 % (of the rated speed i.e. 1800 rpm), it must be entered as 12000.

### 9.3.2.14 Battery Voltage

The measured battery and auxiliary excitation voltage refer to the fix rated battery voltage of 24 V.

#### Analog output example

- The source value at maximum output is configured to 120.00 % (of the rated voltage i.e. 28.8 V).
- The source value at minimum output is configured to 20.00 % (of the rated voltage i.e. 4.8 V).
- The analog output range is configured to 0 to 20 mA.
- If a battery voltage of 4.8 V (or below) is measured, the analog output issues its lower limit (i.e. 0 mA).
- If a battery voltage of 28.8 V (or above) is measured, the analog output issues its upper limit (i.e. 20 mA).
- If a battery voltage of 16.8 V is measured, the analog output issues 50 % of its upper limit (i.e. 10 mA).
- If a battery voltage of 24 V is measured, the analog output issues 80 % of its upper limit (i.e. 16 mA).

#### Flexible limit example

- If the flexible limit is to be configured to 120.00 % (of the rated voltage i.e. 28.8 V), it must be entered as 12000.

### 9.3.2.15 Busbar 1 Rated Voltage

The busbar 1 delta voltage values refer to the busbar 1 rated voltage (parameter 1781 ↗ p. 95).

#### Analog output example

- The busbar 1 rated voltage (parameter 1781 ↗ p. 95) is configured to 400 V.
- The source value at maximum output is configured to 110.00 % (of the rated voltage i.e. 440 V).
- The source value at minimum output is configured to 10.00 % (of the rated voltage i.e. 40 V).
- The analog output range is configured to 0 to 20 mA.
- If a busbar 1 voltage of 40 V (or below) is measured, the analog output issues its lower limit (i.e. 0 mA).
- If a busbar 1 voltage of 440 V (or above) is measured, the analog output issues its upper limit (i.e. 20 mA).
- If a busbar 1 voltage of 240 V is measured, the analog output issues 50 % of its upper limit (i.e. 10 mA).
- If a busbar 1 voltage of 400 V is measured, the analog output issues 90 % of its upper limit (i.e. 18 mA).

#### Flexible limit example

- The busbar 1 rated voltage (parameter 1781 ↗ p. 95) is configured to 400 V.
- If the flexible limit is to be configured to 110.00 % (of the rated voltage i.e. 440 V), it must be entered as 11000.

### 9.3.2.16 Display Value Format

The analog input values refer to the display value format (refer to parameter 1035 ↗ p. 241).



Delimiters like decimal points or commas are ignored. If the display value format is 0.01 bar for example, a value of 5 bar corresponds with 00500.

#### Analog output example

- An analog input is configured to VDO 120 °C characteristic.
- The source value at maximum output is configured to 00100 (i.e. 100 °C).
- The source value at minimum output is configured to 00020 (i.e. 20 °C).
- The analog output range is configured to 0 to 20 mA.
- If a value of 20 °C (or below) is measured, the analog output issues its lower limit (i.e. 0 mA).
- If a value of 100 °C (or above) is measured, the analog output issues its upper limit (i.e. 20 mA).
- If a value of 60 °C is measured, the analog output issues 50 % of its upper limit (i.e. 10 mA).
- If a value of 84 °C is measured, the analog output issues 80 % of its upper limit (i.e. 16 mA).

#### Flexible limit example

- An analog input is configured to VDO 10 bar characteristic.
- If the flexible limit is to be configured to 5.23 bar, it must be entered as 00523.

See the fixed display value formats below:

Analog input type	Display value format	Example value	Example format
VDO 5 bar	0.01 bar	5.0 bar	500
VDO 10 bar	0.01 bar	6.6 bar	660
VDO 120 °C	1 °C	69 °C	69
VDO 150 °C	1 °C	73 °C	73
Pt100	1 °C	103 °C	103

Table 100: Display value format

## 9.4 LogicsManager Reference

### 9.4.1 LogicsManager Overview

The LogicsManager is used to customize the sequence of events in the control unit such as the start command of the engine or the operation of control unit relay outputs. For example, the start routine may be programmed so that it requires the closing of a discrete input or a preset time of day.

Depending on the application mode of the unit, the number of available relays that may be programmed with the LogicsManager will vary.

Two independent time delays are provided for the configured action to take place and be reset.



Please do not use the output of an equation as input at the same time. Such a configuration could decrease the performance of the interface.

**Structure and description of the LogicsManager**

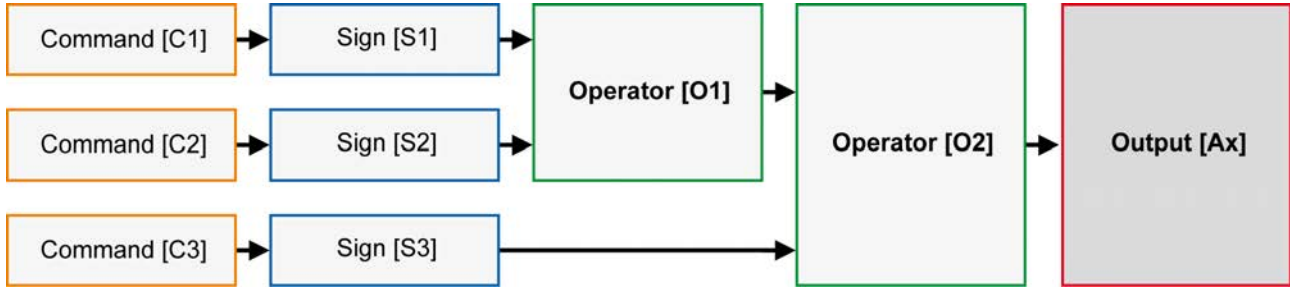

Fig. 302: LogicsManager - function overview

- **Command (variable)**  
 A list of over 400 parameters and functions is provided for the command inputs.  
 Examples of the parameters that may be configured into these commands are generator undervoltage thresholds 1 and 2, start fail, and cool down.  
 These command variables are used to control the output function or relay.  
 Refer to [Chapter 9.4.4 "Logical Command Variables"](#) on page 697 for a complete list of all command variables.
- **Sign**  
 The sign field can be used to invert the state of the command or to fix its output to a logical true or false if the command is not needed. Setting the sign to the NOT state changes the output of the command variable from true to false or vice versa.
- **Operator**  
 A logical device such as AND or OR.
- **(Logical) output**  
 The action or control sequence that occurs when all parameters set into the LogicsManager are met.  
 For a complete list of all logical outputs refer to [Chapter 9.4.3 "Logical Outputs"](#) on page 693.

[Sx] - Sign {x}		
	Value {[Cx]}	The value [Cx] is passed 1:1.
	NOT Value {[Cx]}	The opposite of the value [Cx] is passed.
	0 [False; always "0"]	The value [Cx] is ignored and this logic path will always be FALSE.
	1 [True; always "1"]	The value [Cx] is ignored and this logic path will always be TRUE.

Table 101: Signs

[Ox] - Operator {x}	
AND	Logical AND
NAND	Logical negated AND
OR	Logical OR
NOR	Logical negated OR
XOR	Exclusive OR
NXOR	Exclusive negated OR

Table 102: Operators



For the various display formats of the corresponding logical symbols refer to [Chapter 9.4.2 "Logical Symbols"](#) on page 691.

### Configuration of the command chain

Using the values specified in the above table, the chain of commands of the LogicsManager (for example: operating the relays, setting the flags, specification of the automatic functions) is configured as follows:

$$[Ax] = ( ( [C1] \& [S1] ) \& [O1] \& ( [C2] \& [S2] ) ) \& [O2] \& ( [C3] \& [S3] )$$

### Programming example for the LogicsManager

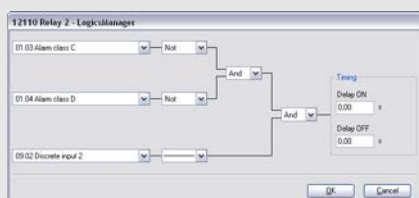

Fig. 303: Programming example (ToolKit)

- Relay [R2] shall energize, whenever "Discrete input [DI 02]" is energized "AND" the control does "NOT" have a fault that is "Alarm class C" "AND" does "NOT" have a fault that is "Alarm class D"

## 9.4.2 Logical Symbols

The following symbols are used for the graphical programming of the LogicsManager. The easYgen displays symbols according to the IEC standard by default.

- Use parameter 4117 [p. 375](#)/[p. 377](#) to change display mode to ASA standard.

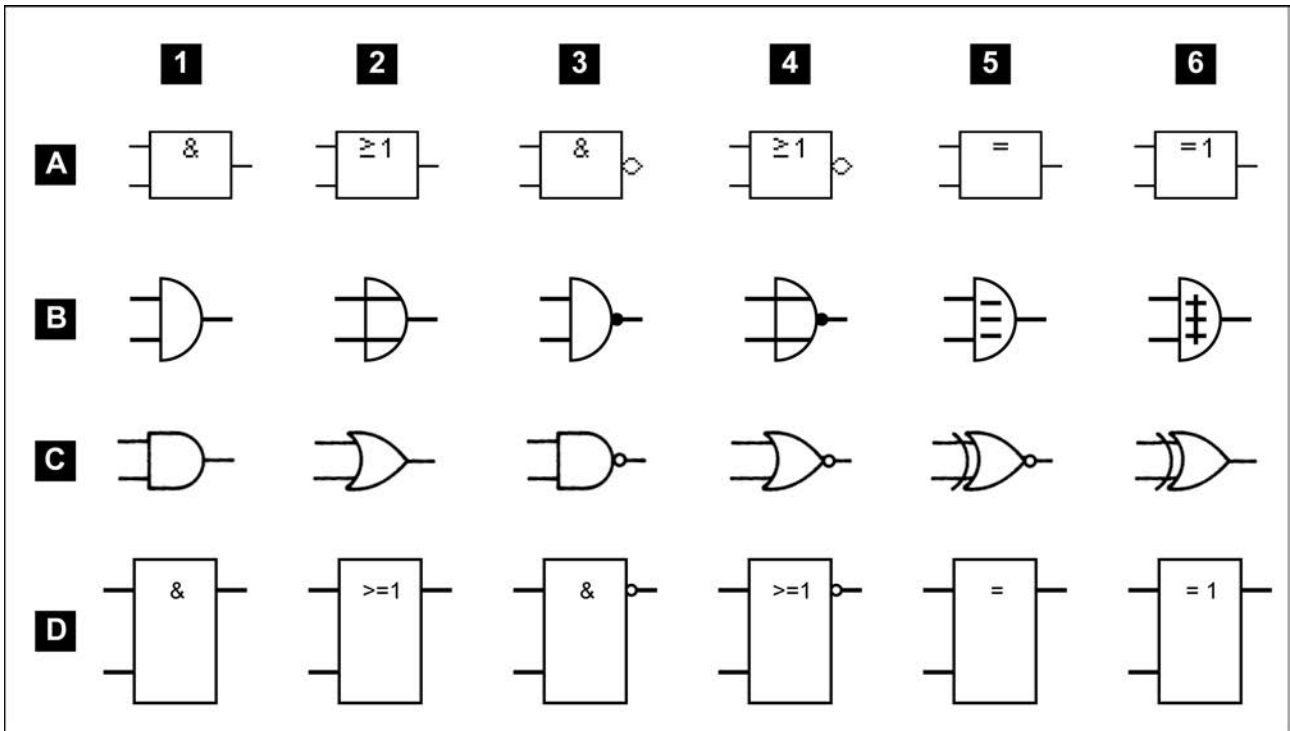

Fig. 304: Logical symbols

Row	... according to standard:
A	easYgen (default: IEC)
B	DIN 40 700
C	ASA US MIL (configurable)
D	IEC617-12

Meaning of the columns					
1	2	3	4	5	6
AND	OR	NAND	NOR	NXOR	XOR

AND				OR				NAND				NOR				NXOR				XOR			
x1	x2	y		x1	x2	y		x1	x2	y		x1	x2	y		x1	x2	y		x1	x2	y	
0	0	0		0	0	0		0	0	1		0	0	1		0	0	1		0	0	0	
0	1	0		0	1	1		0	1	1		0	1	0		0	1	0		0	1	1	
1	0	0		1	0	1		1	0	1		1	0	0		1	0	0		1	0	1	
1	1	1		1	1	1		1	1	0		1	1	0		1	1	1		1	1	0	

Table 103: Truth table

### 9.4.3 Logical Outputs

The logical outputs or combinations may be grouped into three categories:

- Internal logical flags
- Internal functions
- Relay outputs



*The numbers of the logical outputs in the third column may again be used as input variable for other outputs in the LogicsManager.*

#### Internal flags

16 internal logical flags may be programmed to activate/deactivate functions. This permits more than 3 commands to be included in a logical function. They may be used like "auxiliary flags".

Name	Function	Number
Flag 1	Internal flag 1	00.01
Flag 2	Internal flag 2	00.02
Flag 3	Internal flag 3	00.03
Flag 4	Internal flag 4	00.04
Flag 5	Internal flag 5	00.05
Flag 6	Internal flag 6	00.06
Flag 7	Internal flag 7	00.07
Flag 8	Internal flag 8	00.08
Flag 9	Internal flag 9	00.30
Flag 10	Internal flag 10	00.31
Flag 11	Internal flag 11	00.32
Flag 12	Internal flag 12	00.33
Flag 13	Internal flag 13	00.34
Flag 14	Internal flag 14	00.35
Flag 15	Internal flag 15	00.36
Flag 16	Internal flag 16	00.37

#### Internal functions

The following logical functions may be used to activate/deactivate functions.

Name	Function	Number
Start request in AUTO	Start in AUTOMATIC operating mode (parameter 12120 ↗ p. 279)	00.09
Stop request in AUTO	Stop in AUTOMATIC operating mode (parameter 12190 ↗ p. 279)	00.10

Name	Function	Number
Inhibit emergency run	Blocking or interruption of an emergency power operating in AUTOMATIC operating mode (parameter 12200 ↗ p. 277)	00.11
Undelay close GCB	Immediately closing of the GCB after engine start without waiting for the engine delayed monitoring and generator stable timer to expire (parameter 12210 ↗ p. 228)	00.12
Constant idle run	Enables idle/rated speed modes (parameter 12550 ↗ p. 275).	00.14
External acknowledge	The alarm acknowledgement is performed from an external source (parameter 12490 ↗ p. 200)	00.15
Operation mode AUTO	Activation of the AUTOMATIC operating mode (parameter 12510 ↗ p. 280 )	00.16
Operation mode MAN	Activation of the MANUAL operating mode (parameter 12520 ↗ p. 280)	00.17
Operation mode STOP	Activation of the STOP operating mode (parameter 12530 ↗ p. 280)	00.18
Start without load	Starting the engine without closing the GCB (parameter 12540 ↗ p. 279)	00.19
Automatic idle mode	Automatic idle mode (blocks the undervoltage, underfrequency, and underspeed monitoring for a configured time automatically, parameter 12570 ↗ p. 275)	00.20
Discrete f/P +	Raise frequency / real power setpoint (parameter 12900 ↗ p. 351)	00.21
Discrete f/P -	Lower frequency / real power setpoint (parameter 12901 ↗ p. 351)	00.22
Discrete V/PF +	Raise voltage / power factor setpoint (parameter 12902 ↗ p. 351)	00.23
Discrete V/PF -	Lower voltage / power factor setpoint (parameter 12903 ↗ p. 351)	00.24
Freq. Droop active	Activation of the frequency droop (parameter 12904 ↗ p. 307)	00.25
Volt. Droop active	Activation of the voltage droop (parameter 12905 ↗ p. 327)	00.26
Ext. mains decoupling requested	Activation of the mains decoupling function (parameter 12922 ↗ p. 141)	00.27
Critical mode	Activation of critical mode operation (parameter 12220 ↗ p. 299)	00.28
Firing speed	Firing (ignition) speed is reached (parameter 12500 ↗ p. 270)	00.29
Synchronization mode CHECK	Activation of CHECK synchronization mode (parameter 12906 ↗ p. 234)	00.38
Synchroniz. mode PERMISSIVE	Activation of PERMISSIVE synchronization mode (parameter 12907 ↗ p. 233)	00.39
Synchronization mode RUN	Activation of RUN synchronization mode (parameter 12908 ↗ p. 234)	00.40
Frequency setpoint 2	Activates the frequency setpoint 2 (parameter 12918 ↗ p. 306)	00.81
Load setpoint 2	Activates the load setpoint 2 (parameter 12919 ↗ p. 312)	00.82
Voltage setpoint 2	Activates the voltage setpoint 2 (parameter 12920 ↗ p. 326)	00.83
Power factor setpoint 2	Activates the power factor setpoint 2 (parameter 12921 ↗ p. 333)	00.84
Enable MCB	Enables the MCB (parameter 12923 ↗ p. 231)	00.85
Load-dependent start/stop	Activation of load-dependent start/stop (parameter 12930 ↗ p. 285)	00.86
Segment no.2 act	Assigns the genset to load share segm. #2 (parameter 12929 ↗ p. 344)	00.87
Segment no.3 act	Assigns the genset to load share segm. #3 (parameter 12928 ↗ p. 344)	00.88
Segment no.4 act	Assigns the genset to load share segm. #4 (parameter 12927 ↗ p. 344)	00.89
LDSS Priority 2	Sets the LDSS priority to 2 (parameter 12926 ↗ p. 285)	00.90
LDSS Priority 3	Sets the LDSS priority to 3 (parameter 12925 ↗ p. 286)	00.91

Name	Function	Number
LDSS Priority 4	Sets the LDSS priority to 4 (parameter 12924 ↗ p. 286)	00.92
Transition mode 1	Activates breaker transition mode 1 (parameter 12931 ↗ p. 223)	00.93
Transition mode 2	Activates breaker transition mode 2 (parameter 12932 ↗ p. 224)	00.94

### Priority hierarchy of the logical outputs

The following table contains the priority relationships between the start conditions of the logical outputs in the LogicsManager:

Prioritized function	Overrides	Reaction
Critical mode	Stop req. in Auto	A start will still be performed.
	Start req. in Auto	The behavior of the system depends on the configuration of the related parameters.
Stop req. in Auto	Start req. in Auto	No start will be performed.
	Emergency power	No start will be performed.
	Idle mode	No start will be performed.
Start w/o load	Start req. in Auto	The GCB remains open / will be opened.
Emergency power	Start w/o load	The GCB will be closed nevertheless.
	Critical mode	The GCB will be closed nevertheless. The alarm class management is still performed like for the critical mode. If emergency power is already enabled and the critical mode will be enabled then, a pause time may be configured for the emergency power operation.
Inhibit emergency run	Emergency power	No start will be performed.
	Emergency power during Start w/o load	The generator keeps on running without taking over load.

### Relay outputs

All relays may be controlled directly by the LogicsManager depending on the respective application mode.

Name	Function	Number
Relay 1 (Ready for operation OFF)	If this logical output becomes true, the relay output 1 will be activated	00.41
Relay 2	If this logical output becomes true, the relay output 2 will be activated	00.42
Relay 3	If this logical output becomes true, the relay output 3 will be activated	00.43
Relay 4	If this logical output becomes true, the relay output 4 will be activated	00.44
Relay 5	If this logical output becomes true, the relay output 5 will be activated	00.45
Relay 6	If this logical output becomes true, the relay output 6 will be activated	00.46
Relay 7	If this logical output becomes true, the relay output 7 will be activated	00.47
Relay 8	If this logical output becomes true, the relay output 8 will be activated	00.48
Relay 9	If this logical output becomes true, the relay output 9 will be activated	00.49

Name	Function	Number
Relay 10	If this logical output becomes true, the relay output 10 will be activated	00.50
Relay 11	If this logical output becomes true, the relay output 11 will be activated	00.51
Relay 12	If this logical output becomes true, the relay output 12 will be activated	00.52

Name	Function	Number
External DO 1	If this logical output becomes true, the external relay output 1 will be activated	00.63
External DO 2	If this logical output becomes true, the external relay output 2 will be activated	00.64
External DO 3	If this logical output becomes true, the external relay output 3 will be activated	00.65
External DO 4	If this logical output becomes true, the external relay output 4 will be activated	00.66
External DO 5	If this logical output becomes true, the external relay output 5 will be activated	00.67
External DO 6	If this logical output becomes true, the external relay output 6 will be activated	00.68
External DO 7	If this logical output becomes true, the external relay output 7 will be activated	00.69
External DO 8	If this logical output becomes true, the external relay output 8 will be activated	00.70
External DO 9	If this logical output becomes true, the external relay output 9 will be activated	00.71
External DO 10	If this logical output becomes true, the external relay output 10 will be activated	00.72
External DO 11	If this logical output becomes true, the external relay output 11 will be activated	00.73
External DO 12	If this logical output becomes true, the external relay output 12 will be activated	00.74
External DO 13	If this logical output becomes true, the external relay output 13 will be activated	00.75
External DO 14	If this logical output becomes true, the external relay output 14 will be activated	00.76
External DO 15	If this logical output becomes true, the external relay output 15 will be activated	00.77
External DO 16	If this logical output becomes true, the external relay output 16 will be activated	00.78

Name	Function	Number
 P2 package P2 only		
External DO 17	If this logical output becomes true, the external relay output 1 will be activated	23.01
External DO 18	If this logical output becomes true, the external relay output 2 will be activated	23.02
External DO 19	If this logical output becomes true, the external relay output 3 will be activated	23.03
External DO 20	If this logical output becomes true, the external relay output 4 will be activated	23.04
External DO 21	If this logical output becomes true, the external relay output 5 will be activated	23.05
External DO 22	If this logical output becomes true, the external relay output 6 will be activated	23.06
External DO 23	If this logical output becomes true, the external relay output 7 will be activated	23.07
External DO 24	If this logical output becomes true, the external relay output 8 will be activated	23.08
External DO 25	If this logical output becomes true, the external relay output 9 will be activated	23.09
External DO 26	If this logical output becomes true, the external relay output 10 will be activated	23.10
External DO 27	If this logical output becomes true, the external relay output 11 will be activated	23.11





Name	Function	Number
External DO 28	If this logical output becomes true, the external relay output 12 will be activated	23.12
External DO 29	If this logical output becomes true, the external relay output 13 will be activated	23.13
External DO 30	If this logical output becomes true, the external relay output 14 will be activated	23.14
External DO 31	If this logical output becomes true, the external relay output 15 will be activated	23.15
External DO 32	If this logical output becomes true, the external relay output 16 will be activated	23.16

Relay		Application mode (parameter 3401 ↗ p. 222)			
No.	Term.	None <b>A01</b>	GCBopen <b>A02</b>	GCB <b>A03</b>	GCB/MCB <b>A04</b>
Internal relay outputs, board #1					
[R 01]	41/42	'Ready for operation'; additionally programmable with LogicsManager <b>CAUTION!</b> Only relay [R 01] has an inverse logic. The relay opens (all other relays close), if the logical output of the LogicsManager becomes TRUE.			
[R 02]	43/46	LogicsManager; pre-assigned with 'Centralized alarm (horn)'			
[R 03]	44/46	LogicsManager; pre-assigned with 'Starter'			
[R 04]	45/46	LogicsManager; pre-assigned with 'Diesel: Fuel solenoid, Gas: Gas valve'			
[R 05]	47/48	LogicsManager; pre-assigned with 'Diesel: Preglow, Gas: Ignition'			
[R 06]	49/50	LogicsManager		Command: close GCB	
[R 07]	51/52	LogicsManager	Command: open GCB		
[R 08]	53/54	LogicsManager			Command: close MCB
[R 09]	55/56	LogicsManager			Command: open MCB
[R 10]	57/60	LogicsManager; pre-assigned with 'Auxiliary services'			
[R 11]	58/60	LogicsManager; pre-assigned with 'Alarm class A, B active'			
[R 12]	59/60	LogicsManager; pre-assigned with 'Alarm class C, D, E, F active'			

#### 9.4.4 Logical Command Variables

The logical command variables are grouped into different categories

- Group 00: Flags condition 1
- Group 01: Alarm system
- Group 02: Systems condition
- Group 03: Engine control
- Group 04: Applications condition
- Group 05: Engine related alarms
- Group 06: Generator related alarms
- Group 07: Mains related alarms
- Group 08: System related alarms
- Group 09: Discrete inputs
- Group 10: Analog inputs
- Group 11: Clock and timer

- Group 12: External DIs 1
- Group 13: Discrete outputs
- Group 14: External DOs 1
- Group 15: Flexible limits
- Group 17: Alarm system 2
- Group 22: External DIs 2,  package 2 only
- Group 23: External DOs 2,  package 2 only
- Group 24: Flags condition 2
- Group 25: Ext. Analog inputs



**Devices, packages, and versions**

The following tables are describing a full set of parameters. Please ignore data your device does not support.





**ID Numbers**

The following tables list the "ID" numbers used e.g. for Modbus communication.

**9.4.4.1 Group 00: Flags Condition 1**

- Flags condition 1
- Logic command variables 00.01-00.99

Internal Flags are the result of the output of the logic ladders from Flag 1 to 16. Flags are internal logic that can be sent to other flags or Command variables.

No.	ID	Name	Function	Note
00.01	0	LM: Flag 1	Internal flag 1	Internal calculation Refer to  "Internal flags" on page 693.
00.02	1	LM: Flag 2	Internal flag 2	
00.03	2	LM: Flag 3	Internal flag 3	
00.04	3	LM: Flag 4	Internal flag 4	
00.05	4	LM: Flag 5	Internal flag 5	
00.06	5	LM: Flag 6	Internal flag 6	
00.07	6	LM: Flag 7	Internal flag 7	
00.08	7	LM: Flag 8	Internal flag 8	
00.09	8	LM: Start request in AUTO	Start in AUTOMATIC operating mode	Internal calculation Refer to parameter 12120  p. 279.
00.10	9	LM: Stop request in AUTO	Stop in AUTOMATIC operating mode	Internal calculation Refer to parameter 12190  p. 279.

No.	ID	Name	Function	Note
00.11	10	LM: Inhibit emergency run	Blocking or interruption of an emergency power operation in AUTOMATIC operating mode	Internal calculation Refer to parameter 12200 ↗ p. 277.
00.12	11	LM: Undelay close GCB	Immediately closing of the GCB without waiting for the engine delayed monitoring timer to expire	Internal calculation Refer to parameter 12210 ↗ p. 228.
00.13	12	Reserved		
00.14	13	LM: Constant idle run	Constant idle speed mode enabled (blocks alarm for undervoltage, underfrequency, and underspeed constantly)	Internal calculation Refer to parameter 12550 ↗ p. 275.
00.15	14	LM: External acknowledge	The alarm acknowledgement is performed from an external source	Internal calculation Refer to parameter 12490 ↗ p. 200.
00.16	15	LM: Operation mode AUTO	Activation of the AUTOMATIC operating mode	Internal calculation Refer to parameter 12510 ↗ p. 280.
00.17	16	LM: Operation mode MAN	Activation of the MANUAL op. mode	Internal calculation Refer to parameter 12520 ↗ p. 280.
00.18	17	LM: Operation mode STOP	Activation of the STOP operating mode	Internal calculation Refer to parameter 12530 ↗ p. 280.
00.19	18	LM: Start w/o load	Starting the engine without closing the GCB	Internal calculation Refer to parameter 12540 ↗ p. 279.
00.20	19	LM: Automatic idle mode	Automatic idle speed mode (blocks alarm for undervoltage, underfrequency, and underspeed automatically for a set time)	Internal calculation Refer to parameter 12570 ↗ p. 275.
00.21	20	LM: Discrete f/P +	Raise frequency / real power set-point	Internal calculation Refer to parameter 12900 ↗ p. 351.
00.22	21	LM: Discrete f/P -	Lower frequency / real power set-point	Internal calculation Refer to parameter 12901 ↗ p. 351.
00.23	22	LM: Discrete V/PF +	Raise voltage / power factor set-point	Internal calculation Refer to parameter 12902 ↗ p. 351.
00.24	23	LM: Discrete V/PF -	Lower voltage / power factor set-point	Internal calculation Refer to parameter 12903 ↗ p. 351.
00.25	24	LM: Freq. Droop active	Frequency droop active	Internal calculation Refer to parameter 12904 ↗ p. 307.

## Appendix

No.	ID	Name	Function	Note
00.26	25	LM: Volt. Droop active	Voltage droop active	Internal calculation Refer to parameter 12905 ↗ p. 327.
00.27	26	LM: External mains decoupling	External mains failure detected	Internal calculation Refer to parameter 12922 ↗ p. 141.
00.28	27	LM: Critical mode	Activation of critical mode operation	Internal calculation Refer to parameter 12220 ↗ p. 299.
00.29	28	LM: Firing speed	Firing (ignition) speed is reached.	Internal calculation Refer to parameter 12500 ↗ p. 270.
00.30	29	LM: Flag 9	Internal flag 9	Internal calculation Refer to ↗ “Internal flags” on page 693.
00.31	30	LM: Flag 10	Internal flag 10	
00.32	31	LM: Flag 11	Internal flag 11	
00.33	32	LM: Flag 12	Internal flag 12	
00.34	33	LM: Flag 13	Internal flag 13	
00.35	34	LM: Flag 14	Internal flag 14	
00.36	35	LM: Flag 15	Internal flag 15	
00.37	36	LM: Flag 16	Internal flag 16	
00.38	37	LM: Syn. mode CHECK	Activation of CHECK synch. mode	Internal calculation Refer to parameter 12906 ↗ p. 234.
00.39	38	LM: Syn. mode PERMIS.	Activation of PERMISSIVE synch. mode	Internal calculation Refer to parameter 12907 ↗ p. 233.
00.40	39	LM: Syn. mode RUN	Activation of RUN synch. mode	Internal calculation Refer to parameter 12908 ↗ p. 234.
00.41	40	LM: Relay 1		TRUE, if the LogicsManager condition driving this relay is fulfilled.
00.42	41	LM: Relay 2		
00.43	42	LM: Relay 3		
00.44	43	LM: Relay 4		
00.45	44	LM: Relay 5		
00.46	45	LM: Relay 6		
00.47	46	LM: Relay 7		
00.48	47	LM: Relay 8		
00.49	48	LM: Relay 9		
00.50	49	LM: Relay 10		
00.51	50	LM: Relay 11		

No.	ID	Name	Function	Note
00.52	51	LM: Relay 12		
00.53	52	Reserved		
00.54	53	Reserved		
00.55	54	Reserved		
00.56	55	Reserved		
00.57	56	Reserved		
00.58	57	Reserved		
00.59	58	Reserved		
00.60	59	Reserved		
00.61	60	Reserved		
00.62	61	Reserved		
00.63	62	LM: External relay DO 1		TRUE, if the LogicsManager condition driving this relay is fulfilled
00.64	63	LM: External relay DO 2		
00.65	64	LM: External relay DO 3		
00.66	65	LM: External relay DO 4		
00.67	66	LM: External relay DO 5		
00.68	67	LM: External relay DO 6		
00.69	68	LM: External relay DO 7		
00.70	69	LM: External relay DO 8		
00.71	70	LM: External relay DO 9		
00.72	71	LM: External relay DO 10		
00.73	72	LM: External relay DO 11		
00.74	73	LM: External relay DO 12		
00.75	74	LM: External relay DO 13		
00.76	75	LM: External relay DO 14		
00.77	76	LM: External relay DO 15		
00.78	77	LM: External relay DO 16		
00.79	78	Reserved		
00.80	79	Reserved		
00.81	80	LM: Setpoint 2 frequency	Activation of frequency setpoint 2	Internal calculation Refer to parameter 12918 ↗ p. 306.
00.82	81	LM: Setpoint 2 load	Activation of load setpoint 2	Internal calculation Refer to parameter 12919 ↗ p. 312.
00.83	82	LM: Setpoint 2 voltage	Activation of voltage setpoint 2	Internal calculation Refer to parameter 12920 ↗ p. 326.

No.	ID	Name	Function	Note
00.84	83	LM: Setpoint 2 power factor	Activation of power factor setpoint 2	Internal calculation Refer to parameter 12921 ↗ p. 333.
00.85	84	LM: Enable MCB	MCB is enabled	Internal calculation Refer to parameter 12923 ↗ p. 231.
00.86	85	LM: LD start/stop	Activation of load-dependent start/stop	Internal calculation Refer to parameter 12930 ↗ p. 285.
00.87	86	LM: Segment no.2 act	Assigns the genset to load share segm. 2	Internal calculation Refer to parameter 12929 ↗ p. 344.
00.88	87	LM: Segment no.3 act	Assigns the genset to load share segm. 3	Internal calculation Refer to parameter 12928 ↗ p. 344.
00.89	88	LM: Segment no.4 act	Assigns the genset to load share segm. 4	Internal calculation Refer to parameter 12927 ↗ p. 344.
00.90	89	LM: LDSS Priority 2	Sets the LDSS priority to 2	Internal calculation Refer to parameter 12926 ↗ p. 285.
00.91	90	LM: LDSS Priority 3	Sets the LDSS priority to 3	Internal calculation Refer to parameter 12925 ↗ p. 286.
00.92	91	LM: LDSS Priority 4	Sets the LDSS priority to 4	Internal calculation Refer to parameter 12924 ↗ p. 286.
00.93	92	LM: Transition mode 1	Activates breaker transition mode 1	Internal calculation Refer to parameter 12931 ↗ p. 223.
00.94	93	LM: Transition mode 2	Activates breaker transition mode 1	Internal calculation Refer to parameter 12932 ↗ p. 224.
00.95	94	Reserved		
00.96	95	Release f-control	Release frequency control	Refer to parameter 12909 ↗ p. 308.
00.97	96	Release V-control	Release voltage control	Refer to parameter 12938 ↗ p. 327.
00.98	97	LM: F/P control	Activation of active power control	
00.99	98	LM: V/Q control	Activation of reactive power control	

**9.4.4.2 Group 01: Alarm System**

- Alarm system
- Logic command variables 01.01-01.11

Alarm classes may be configured as command variables for all logical outputs in the LogicsManager. Refer to [Chapter 9.5.1 “Alarm Classes” on page 733](#) for a description of the alarm classes.

No.	ID	Name / Function	Note
01.01	99	Alarm class A	TRUE as long as an alarm of this alarm class is active or latched (triggered)
01.02	100	Alarm class B	TRUE as long as an alarm of this alarm class is active or latched (triggered)
01.03	101	Alarm class C	TRUE as long as an alarm of this alarm class is active or latched (triggered)
01.04	102	Alarm class D	TRUE as long as an alarm of this alarm class is active or latched (triggered)
01.05	103	Alarm class E	TRUE as long as an alarm of this alarm class is active or latched (triggered)
01.06	104	Alarm class F	TRUE as long as an alarm of this alarm class is active or latched (triggered)
01.07	105	All alarm classes	TRUE as long as at least one alarm of the alarm classes A/B/C/D/E/F is active or latched (triggered)
01.08	106	Warning alarm	TRUE as long as at least one alarm of the alarm classes A/B is active or latched (triggered)
01.09	107	Shutdown alarm	TRUE as long as at least one alarm of the alarm classes C/D/E/F is active or latched (triggered)
01.10	108	Centralized alarm	TRUE as long as at least one alarm of the alarm classes B/C/D/E/F is active or latched (triggered)
01.11	109	New alarm triggered	TRUE if any alarm has been triggered until it is acknowledged

**9.4.4.3 Group 02: Systems Condition**

- Systems condition
- Logic command variables 02.01-02.21

The status of the system may be used as command variable in a logical output to set parameters for customized operations.

No.	ID	Name	Function	Note
02.01	119	Firing speed detected	Firing speed recognized (via MPU/gen. frequency / LogicsManager)	TRUE as long as at least firing speed is measured (defined by parameter 3313 ↗ p. 270) either via the MPU or the generator frequency; or is detected via the LogicsManager output "ignition speed reached" (defined by parameters 3324 ↗ p. 270 and 12500 ↗ p. 270)
02.02	120	Speed detected	Speed recognized (via MPU/gen. frequency / LogicsManager)	TRUE as long as a speed is measured (this can be lower than the ignition speed; either via the MPU, the generator frequency, or the LogicsManager output "ignition speed reached")
02.03	121	Generator voltage ok	Generator voltage within operating range	TRUE as long as the generator voltage is within the operating range
02.04	122	Generator frequency ok	Generator frequency within operating range	TRUE as long as the generator frequency is within the operating range
02.05	123	Generator ok	Generator voltage and frequency within operating ranges	TRUE as long as the generator voltage and frequency are within the operating ranges (02.03. and 02.04 are TRUE)
02.06	124	Busbar 1 voltage ok	Busbar 1 voltage within generator voltage operating range	TRUE as long as the busbar 1 voltage is within the generator voltage operating range
02.07	125	Busbar 1 frequency ok	Busbar 1 frequency within frequency voltage operating range	TRUE as long as the busbar 1 frequency is within the generator frequency operating range
02.08	126	Busbar 1 ok	Busbar 1 voltage and frequency within generator voltage and frequency operating ranges	TRUE as long as the busbar 1 voltage and frequency are within the generator voltage operating ranges (02.06. and 02.07 are TRUE)
02.09	127	Mains voltage ok	Mains voltage within operating range	TRUE as long as the mains voltage is within the operating range
02.10	128	Mains frequency ok	Mains frequency within operating range	TRUE as long as the mains frequency is within the operating range
02.11	129	Mains ok	Mains voltage and frequency within operating ranges	TRUE as long as the mains voltage and frequency are within the operating ranges (02.09. and 02.10 are TRUE)
02.12	130	Generator rotation CCW	Generator voltage: rotating direction CCW	TRUE as long as the respective rotation field is detected in case of a three-phase voltage measurement at the respective measuring location
02.13	131	Generator rotation CW	Generator voltage: rotating direction CW	
02.14	132	Mains rotation CCW	Mains voltage: rotating direction CCW	
02.15	133	Mains rotation CW	Mains voltage: rotating direction CW	
02.16	134	Busbar 1 rotation CCW	Busbar voltage: rotating direction CCW	
02.17	135	Busbar 1 rotation CW	Busbar voltage: rotating direction CW	
02.18	136	Reserved		
02.19	137	Reserved		







No.	ID	Name	Function	Note
02.20	138	Reserved		
02.21	139	Busbar 1 is dead	Busbar 1 is dead	TRUE as long as the busbar voltage is below the value configured in parameter 5820 ↗ p. 224 (Dead bus detection max. volt.)

#### 9.4.4.4 Group 03: Engine Control

- Engine control
- Logic command variables 03.01-03.37

These variables may be used as command variable in a logical output to set parameters for customized operations.

No.	ID	Name / Function	Note
03.01	179	Auxiliary services	TRUE if an auxiliary services prerun or postrun is enabled
03.02	180	Starter	TRUE if the starter relay is energized
03.03	181	Reserved	
03.04	182	Preglow (Diesel) Ignition (Gas)	TRUE if the preglow (Diesel) or ignition (gas) relay is energized
03.05	183	Horn (active)	TRUE if alarm class B to F is activated until the time until horn reset is expired or it is acknowledged for the first time.
03.06	184	Engine released	TRUE if the engine is requested and the start is released
03.07	185	Engine delay over (engine delayed monitoring expired)	TRUE after expiration of the "delayed engine monitoring" timer until the fuel relay is de-energized
03.08	186	Breaker delay over (engine delayed monitoring expired)	TRUE after expiration of the "breaker delay" timer until the fuel relay is de-energized (= CB may be closed)
03.09	187	Reserved	
03.10	188	Reserved	
03.11	189	Reserved	
03.12	190	Reserved	
03.13	191	Blinking lamp ECU	TRUE as soon as the ECU activates the diagnosis light (only for Scania S6 ECU). This command variable is only active if remote control of the ECU via easYgen is activated.
03.14	192	ECU special ignition	TRUE as long as a reset or read-out of the Scania S6 ECU blink code is requested (only for S6 Scania ECU). This command variable is only active if remote control of the ECU via easYgen is activated.
03.15	193	Reserved	
03.16	194	Reserved	
03.17	195	Reserved	
03.18	196	Reserved	
03.19	197	Reserved	

No.	ID	Name / Function	Note
03.20	198	Three-position controller output: frequency / active power (governor) raise	TRUE if the respective three-position controller issues the respective control pulse
03.21	199	Three-position controller output: frequency / active power (governor) lower	
03.22	200	Three-position controller output: voltage / reactive power (AVR) raise	
03.23	201	Three-position controller output: voltage / reactive power (AVR) lower	
03.24	202	Excitation AVR	TRUE if the easYgen excitation is activated
03.25	203	Reserved	
03.26	204	Reserved	
03.27	205	Stopping solenoid (Diesel)	TRUE if a stop signal is issued until the stop time of engine expires
03.28	206	Operating solenoid (Diesel) Gas valve (Gas)	TRUE if the fuel solenoid (Diesel) or gas valve (gas) relay is energized
03.29	207	Reserved	
03.30	208	Auxiliary services prerun	TRUE, if "Auxiliary services prerun" is active
03.31	209	Auxiliary services postrun	TRUE, if "Auxiliary services postrun" is active
03.32	210	+ PID1 controller	 available in package 2 only! TRUE if the respective three-position controller issues the respective control pulse
03.33	211	- PID1 controller	
03.34	212	+ PID2 controller	
03.35	213	- PID2 controller	
03.36	214	+ PID3 controller	
03.37	215	- PID3 controller	
03.38	216	reserved	
03.39	217	Neutral cont. closed	
03.40	218	Remote Shutdown	
03.41	219	Cyl.tmp.lev.1	 Available at package 2 . Cylinder temperature level #1
03.42	220	Cyl.tmp.lev.2	 Available at package 2 . Cylinder temperature level #1
03.43	221	Cyl.tmp.wire.brk.	 Available at package 2 . Cylinder temperature monitoring: wire break

#### 9.4.4.5 Group 04: Applications Condition

- Applications condition
- Logic command variables 04.01-04.60

These operating statuses may be used as command variable in a logical output to set parameters for customized operations.

No.	ID	Name	Function	Note
04.01	239	Auto mode	AUTOMATIC operating mode active	TRUE in AUTOMATIC operating mode
04.02	240	Stop mode	STOP operating mode active	TRUE in STOP operating mode
04.03	241	Manual mode	MANUAL operating mode active	TRUE in MANUAL operating mode
04.04	242	Lamp test	A lamp test is being performed	TRUE if the lamp test is active
04.05	243	Acknowledge	"Acknowledge" push button has been pressed or an external acknowledgment via Logics-Manager	This condition is TRUE for approx. 40 ms and must be extended utilizing a delay time
04.06	244	GCB closed	GCB is closed <b>A03</b> and <b>A04</b>	TRUE if DI 8 (Reply GCB) is de-energized
04.07	245	MCB closed	MCB is closed <b>A04</b> only	TRUE if DI 7 (Reply MCB) is de-energized
04.08	246	Reserved		
04.09	247	Emergency mode	Emergency power operation active	TRUE with the expiration of the emergency power delay; FALSE with the expiration of the mains settling time and the reply from the MCB is closed
04.10	248	Cool down	Engine cool-down cycle active	TRUE as long as the cool down time is running
04.11	249	Mains settling	Mains settling time active	Becomes TRUE with a mains failure and FALSE after the mains settling timer has expired
04.12	250	Start w/o load	Start without closing GCB is active	TRUE if Start w/o load is enabled
04.13	251	Remote request	Request over remote control to activate a function	TRUE if the start bit is set via serial connection (Modbus) or CAN bus (CANopen), (control word 503)
04.14	252	Remote acknowledge	Request over remote control to acknowledge	TRUE if this bit is set via interface (control word 503)
04.15	253	Idle run active	Idle mode is active	TRUE if the idle mode is active. This may be used to issue an "Idle" command to a speed controller.
04.16	254	Reserved		
04.17	255	Reserved		
04.18	256	Synchron. GCB active	Synchronization GCB is active	TRUE if the GCB shall be synchronized until the GCB is closed
04.19	257	Opening GCB active	Opening GCB is active	TRUE if a GCB open command is issued until DI 8 (Reply GCB) is energized
04.20	258	Closing GCB active	Closing GCB is active	TRUE if a GCB close command is issued; same function as relay 6 in <b>A03</b> or <b>A04</b>
04.21	259	Syn. MCB is active	Synchronization MCB is active	TRUE if the MCB shall be synchronized until the MCB is closed
04.22	260	Opening MCB active	Opening MCB is active	TRUE if an MCB open command is issued until DI 7 (Reply GCB) is energized

No.	ID	Name	Function	Note
04.23	261	Closing MCB active	Closing MCB is active	TRUE if an MCB close command is issued; same function as relay 8 in <b>A04</b>
04.24	262	Reserved		
04.25	263	Reserved		
04.26	264	Reserved		
04.27	265	Critical mode	Critical mode operation is enabled	TRUE if critical mode is enabled
04.28	266	Generator unloading	Generator unloading sequence is active	TRUE if a stop command has been issued until the GCB is opened
04.29	267	Mains unloading	Mains unloading sequence is active	TRUE if a synchronization has been started until the MCB is opened
04.30	268	Power limited prerun	Prerun operation with power limitation is active	TRUE as long as the warm up load limitation is enabled
04.31	269	Segment no.2 act	Load share group 2 is activated	Internal calculation Refer to parameter 12929 ↗ p. 344.
04.32	270	Segment no.3 act	Load share group 3 is activated	Internal calculation Refer to parameter 12928 ↗ p. 344.
04.33	271	Segment no.4 act	Load share group 4 is activated	Internal calculation Refer to parameter 12927 ↗ p. 344.
04.34	272	LDSS Priority 2	Load-dependent start/stop priority 2 is activated	Internal calculation Refer to parameter 12926 ↗ p. 285.
04.35	273	LDSS Priority 3	Load-dependent start/stop priority 3 is activated	Internal calculation Refer to parameter 12925 ↗ p. 286.
04.36	274	LDSS Priority 4	Load-dependent start/stop priority 4 is activated	Internal calculation Refer to parameter 12924 ↗ p. 286.
04.37	275	Remote volt. setp. 2	Voltage setpoint 2 is enabled	TRUE if this bit is set via interface (control word 504)
04.38	276	Remote freq. setp. 2	Frequency setpoint 2 is enabled	
04.39	277	Remote PF setp. 2	Power factor setpoint 2 is enabled	
04.40	278	Remote pwr. setp. 2	Load setpoint 2 is enabled	
04.41	279	Transition mode 1	Breaker transition mode alternative 1	Internal calculation Refer to parameter 12931 ↗ p. 223.
04.42	280	Transition mode 2	Breaker transition mode alternative 2	Internal calculation Refer to parameter 12932 ↗ p. 224.
04.43	281	LD start/stop	Load-dependent start/stop is activated	Internal calculation Refer to parameter 12930 ↗ p. 285.
04.44	282	Interface Control 1	Free control bit 1 is activated	Refer to ↗ <i>Chapter 7 "Interfaces And Protocols"</i> on page 521
04.45	283	Interface Control 2	Free control bit 2 is activated	

No.	ID	Name	Function	Note
04.46	284	Interface Control 3	Free control bit 3 is activated	
04.47	285	Interface Control 4	Free control bit 4 is activated	
04.48	286	Interface Control 5	Free control bit 5 is activated	
04.49	287	Interface Control 6	Free control bit 6 is activated	
04.50	288	Interface Control 7	Free control bit 7 is activated	
04.51	289	Interface Control 8	Free control bit 8 is activated	
04.52	290	Interface Control 9	Free control bit 9 is activated	
04.53	291	Interface Control 10	Free control bit 10 is activated	
04.54	292	Interface Control 11	Free control bit 11 is activated	
04.55	293	Interface Control 12	Free control bit 12 is activated	
04.56	294	Interface Control 13	Free control bit 13 is activated	
04.57	295	Interface Control 14	Free control bit 14 is activated	
04.58	296	Interface Control 15	Free control bit 15 is activated	
04.59	297	Interface Control 16	Free control bit 16 is activated	
04.60	298	Crit. mode postrun	Critical mode postrun is active	

#### 9.4.4.6 Group 05: Engine Related Alarms

- Engine related alarms
- Logic command variables 05.01-05.16

These engine alarms may be used as command variable in a logical output to set parameters for customized operations.

No.	ID	Name / Function	Note
05.01	299	Overspeed (limit) 1	TRUE = alarm latched (triggered) FALSE = alarm acknowledged
05.02	300	Overspeed (limit) 2	
05.03	301	Underspeed (limit) 1	
05.04	302	Underspeed (limit) 2	
05.05	303	Unintended stop	

No.	ID	Name / Function	Note
05.06	304	Engine stop malfunction	
05.07	305	Speed/frequency mismatch	
05.08	306	Start fail	
05.09	307	Maintenance days exceeded	
05.10	308	Maintenance hours exceeded	
05.11	309	Charge alternator low voltage	
05.12	310	Reserved	
05.13	311	Red stop lamp	
05.14	312	Amber warning lamp	
05.15	313	EEPROM failure	
05.16	314	Derating active	TRUE if derating is activated <a href="#">↪ Chapter 4.5.12.3 "Derating (Uprating) Of Power "</a> on page 315
05.18	316	Gen.excitation lim.-Status	TRUE = alarm latched (triggered) FALSE = alarm acknowledged

**9.4.4.7 Group 06: Generator Related Alarms**

- Generator related alarms
- Logic command variables 06.01-06.31

These generator alarms may be used as command variable in a logical output to set parameters for customized operations.

No.	ID	Name / Function	Note
06.01	339	Generator overfrequency (limit) 1	TRUE = alarm latched (triggered) FALSE = alarm acknowledged
06.02	340	Generator overfrequency (limit) 2	
06.03	341	Generator underfrequency (limit) 1	
06.04	342	Generator underfrequency (limit) 2	
06.05	343	Generator overvoltage (limit) 1	
06.06	344	Generator overvoltage (limit) 2	
06.07	345	Generator undervoltage (limit) 1	
06.08	346	Generator undervoltage (limit) 2	
06.09	347	Generator (definite time) overcurrent (limit) 1	
06.10	348	Generator (definite time) overcurrent (limit) 2	
06.11	349	Generator (definite time) overcurrent (limit) 3	
06.12	350	Generator reverse/reduced power (limit) 1	

No.	ID	Name / Function	Note
06.13	351	Generator reverse/reduced power (limit) 2	
06.14	352	Generator overload IOP (limit) 1	
06.15	353	Generator overload IOP (limit) 2	
06.16	354	(Generator) unbalanced load (limit)1	
06.17	355	(Generator) unbalanced load (limit) 2	
06.18	356	Generator (voltage) asymmetry	
06.19	357	Ground fault (limit) 1	
06.20	358	Ground fault (limit) 2	
06.21	359	Generator mismatched phase rotation (rotation field alarm)	
06.22	360	(Generator) inverse time-overcurrent	
06.23	361	Generator overload MOP (limit) 1	
06.24	362	Generator overload MOP (limit) 2	
06.25	363	Generator power factor inductive (limit) 1	
06.26	364	Generator power factor inductive (limit) 2	
06.27	365	Generator power factor capacitive (limit) 1	
06.28	366	Generator power factor capacitive (limit) 2	
06.29	367	Generator active power ramp mismatch	
06.30	368	Generator unloading mismatch	
06.31	369	Out of operating range	

#### 9.4.4.8 Group 07: Mains Related Alarms

- Mains related alarms
- Logic command variables 07.01-07.30

These mains alarms may be used as command variable in a logical output to set parameters for customized operations.

No.	ID	Function	Note
07.01	399	Reserved	
07.02	400	Reserved	
07.03	401	Reserved	
07.04	402	Reserved	
07.05	403	Mains mismatched phase rotation (rotation field alarm)	TRUE = alarm latched (triggered) FALSE = alarm acknowledged
07.06	404	Mains overfrequency (limit) 1	
07.07	405	Mains overfrequency (limit) 2	
07.08	406	Mains underfrequency (limit) 1	
07.09	407	Mains underfrequency (limit) 2	

No.	ID	Function	Note	
07.10	408	Mains overvoltage (limit) 1		
07.11	409	Mains overvoltage (limit) 2		
07.12	410	Mains undervoltage (limit) 1		
07.13	411	Mains undervoltage (limit) 2		
07.14	412	Mains phase shift		
07.15	413	Mains df/dt		
07.16	414	Mains active power mismatch		
07.17	415	Mains power factor inductive (limit) 1		
07.18	416	Mains power factor inductive (limit) 2		
07.19	417	Mains power factor capacitive (limit) 1		
07.20	418	Mains power factor capacitive (limit) 2		
07.21	419	Mains import power (limit) 1		
07.22	420	Mains import power (limit) 2		
07.23	421	Mains export power (limit) 1		
07.24	422	Mains export power (limit) 2		
07.25	423	Mains decoupling		
07.26	424	Reserved		
07.27	425	Mains voltage increase		TRUE = alarm latched (triggered) FALSE = alarm acknowledged
07.28	426	Time-dependent voltage		
07.29	427	QV monitoring 1		
07.30	428	QV monitoring 2		

**9.4.4.9 Group 08: System Related Alarms**

- System related alarms
- Logic command variables 08.01-08.33

These system alarms may be used as command variable in a logical output n to set parameters for customized operations.

No.	ID	Function	Note
08.01	459	Battery overvoltage (limit) 1	TRUE = alarm latched (triggered) FALSE = alarm acknowledged
08.02	460	Battery overvoltage (limit) 2	
08.03	461	Battery undervoltage (limit) 1	
08.04	462	Battery undervoltage (limit) 2	
08.05	463	GCB fail to close	
08.06	464	GCB fail to open	
08.07	465	MCB fail to close	



No.	ID	Function	Note
08.08	466	MCB fail to open	
08.09	467	Reserved	
08.10	468	CAN J1939 communication alarm	
08.11	469	Reserved	
08.12	470	Reserved	
08.13	471	Reserved	
08.14	472	Reserved	
08.15	473	Reserved	
08.16	474	Parameter alignment	
08.17	475	Missing members	
08.18	476	CANopen Interface 1	
08.19	477	CANopen Interface 2	
08.20	478	CAN bus overload	
08.21	479	Reserved	
08.22	480	Reserved	
08.23	481	Reserved	
08.24	482	Unit 1 call failed	
08.25	483	Unit 2 call failed	
08.26	484	Unit 3 call failed	
08.27	485	Reserved	
08.28	486	Reserved	
08.29	487	Reserved	
08.30	488	Timeout synchronization GCB	
08.31	489	Timeout synchronization MCB	
08.32	490	Reserved	
08.33	491	Generator /busbar / mains phase rotation mismatch	

#### 9.4.4.10 Group 09: Discrete Inputs

- Discrete inputs
- Logic command variables 09.01-09.12

The discrete inputs may be used as command variable in a logical output to set parameters for customized operations.

No.	ID	Function	Note
09.01	519	DI 1 (Discrete input [DI 01])	TRUE = logical "1" (delay times and N.O./N.C. parameters are ignored)
09.02	520	DI 2 (Discrete input [DI 02])	

No.	ID	Function	Note
09.03	521	DI 3 (Discrete input [DI 03])	FALSE = logical "0" (alarm has been acknowledged or immediately after TRUE condition is not present anymore, if Control is configured as alarm class)
09.04	522	DI 4 (Discrete input [DI 04])	
09.05	523	DI 5 (Discrete input [DI 05])	
09.06	524	DI 6 (Discrete input [DI 06])	
09.07	525	DI 7 (Discrete input [DI 07])	
09.08	526	DI 8 (Discrete input [DI 08])	
09.09	527	DI 9 (Discrete input [DI 09])	
09.10	528	DI 10 (Discrete input [DI 10])	
09.11	529	DI 11 (Discrete input [DI 11])	
09.12	530	DI 12 (Discrete input [DI 12])	

**9.4.4.11 Group 10: Analog Inputs**

- Analog inputs
- Logic command variables 10.01-10.03

The analog inputs may be used as command variable in a logical output.

No.	ID	Name / Function	Note
10.01	559	Analog input AI 01 wire break	TRUE = measured value out of range  FALSE = logical "0" (alarm has been acknowledged, or immediately after TRUE condition is not present anymore, if Control is configured as alarm class)
10.02	560	Analog input AI 02 wire break	
10.03	561	Analog input AI 03 wire break	

**9.4.4.12 Group 11: Clock And Timer**

- Clock and timer
- Logic command variables 11.01-11.10

Time functions may be used as command variable in a logical output.

No.	ID	Name / Function	Note
11.01	579	Timer setpoint 1 (exceeded)	Refer to parameter 1652 ↗ p. 377, 1651 ↗ p. 377 and 1650 ↗ p. 377.
11.02	580	Timer setpoint 2 (exceeded)	Refer to parameters 1657 ↗ p. 377, 1656 ↗ p. 377 and 1655 ↗ p. 377.
11.03	581	Active weekday (equal to setting)	Refer to parameter 1663 ↗ p. 377.
11.04	582	Active day (equal to setting)	Refer to parameter 1663 ↗ p. 377.
11.05	583	Active hour (equal to setting)	Refer to parameter 1662 ↗ p. 378.
11.06	584	Active minute (equal to setting)	Refer to parameter 1661 ↗ p. 378.
11.07	585	Active second (equal to setting)	Refer to parameter 1660 ↗ p. 378.
11.08	586	Engine (running hours exceeded by) 1 hour	Status changes every operating hour
11.09	587	Engine (running hours exceeded by) 10 hour	Status changes every 10 operating hours
11.10	588	Engine (running hours exceeded by) 100 hour	Status changes every 100 operating hours

#### 9.4.4.13 Group 12: External Discrete Inputs 1

- External discrete inputs 1
- Logic command variables 12.01-12.16

Additional discrete inputs from an expansion board (i.e. IKD 1 extension board) may be used as command variable in a logical output.

No.	ID	Name / Function	Note
12.01	609	External discrete input 1 [D.E01]	TRUE = logical "1" (delay times and N.O./N.C. parameters are ignored)
12.02	610	External discrete input 2 [D.E02]	
12.03	611	External discrete input 3 [D.E03]	FALSE = logical "0" (alarm has been acknowledged, or immediately after TRUE condition is not present anymore, if Control is configured as alarm class)
12.04	612	External discrete input 4 [D.E04]	
12.05	613	External discrete input 5 [D.E05]	
12.06	614	External discrete input 6 [D.E06]	
12.07	615	External discrete input 7 [D.E07]	

No.	ID	Name / Function	Note
12.08	616	External discrete input 8 [D.E08]	
12.09	617	External discrete input 9 [D.E09]	
12.10	618	External discrete input 10 [D.E10]	
12.11	619	External discrete input 11 [D.E11]	
12.12	620	External discrete input 12 [D.E12]	
12.13	621	External discrete input 13 [D.E13]	
12.14	622	External discrete input 14 [D.E14]	
12.15	623	External discrete input 15 [D.E15]	
12.16	624	External discrete input 16 [D.E16]	

**9.4.4.14 Group 13: Discrete Outputs**

- Discrete outputs
- Logic command variables 13.01-13.12

The discrete outputs may be used as command variable in a logical output.

No.	ID	Name / Function	Note
13.01	629	Discrete output DO1 [R01]	TRUE = logical "1" (this condition indicates the logical status of the internal relays)  FALSE = logical "0" (this condition indicates the logical status of the internal relays)
13.02	630	Discrete output DO2 [R02]	
13.03	631	Discrete output DO3 [R03]	
13.04	632	Discrete output DO4 [R04]	
13.05	633	Discrete output DO5 [R05]	
13.06	634	Discrete output DO6 [R06]	
13.07	635	Discrete output DO7 [R07]	
13.08	636	Discrete output DO8 [R08]	
13.09	637	Discrete output DO9 [R09]	
13.10	638	Discrete output DO10 [R10]	
13.11	639	Discrete output DO11 [R11]	
13.12	640	Discrete output DO12 [R12]	

**9.4.4.15 Group 14: External Discrete Outputs 1**

- External discrete outputs 1
- Logic command variables 14.01-14.16

The external discrete outputs may be used as command variable in a logical output.

No.	ID	Name / Function	Note
14.01	669	External discrete output DO1 [R.E01]	TRUE = logical "1" (this condition indicates the logical status of the relays, which are connected via external expansion boards)  FALSE = logical "0" (this condition indicates the logical status of the relays, which are connected via external expansion boards)
14.02	670	External discrete output DO2 [R.E02]	
14.03	671	External discrete output DO3 [R.E03]	
14.04	672	External discrete output DO4 [R.E04]	
14.05	673	External discrete output DO5 [R.E05]	
14.06	674	External discrete output DO6 [R.E06]	
14.07	675	External discrete output DO7 [R.E07]	
14.08	676	External discrete output DO8 [R.E08]	
14.09	677	External discrete output DO9 [R.E09]	
14.10	678	External discrete output DO10 [R.E10]	
14.11	679	External discrete output DO11 [R.E11]	
14.12	680	External discrete output DO12 [R.E12]	
14.13	681	External discrete output DO13 [R.E13]	
14.14	682	External discrete output DO14 [R.E14]	
14.15	683	External discrete output DO15 [R.E15]	
14.16	684	External discrete output DO16 [R.E16]	

#### 9.4.4.16 Group 15: Flexible Limits

- Flexible limits
- Logic command variables 15.01-15.40

The flexible analog input thresholds may be used as command variable in a logical output.

No.	ID	Name / Function	Note
15.01	689	Flexible analog limit 1 (triggered)	TRUE = limit value reached  FALSE = alarm acknowledged
15.02	690	Flexible analog limit 2 (triggered)	
15.03	691	Flexible analog limit 3 (triggered)	
15.04	692	Flexible analog limit 4 (triggered)	
15.05	693	Flexible analog limit 5 (triggered)	
15.06	694	Flexible analog limit 6 (triggered)	
15.07	695	Flexible analog limit 7 (triggered)	
15.08	696	Flexible analog limit 8 (triggered)	
15.09	697	Flexible analog limit 9 (triggered)	
15.10	698	Flexible analog limit 10 (triggered)	

No.	ID	Name / Function	Note
15.11	699	Flexible analog limit 11 (triggered)	
15.12	700	Flexible analog limit 12 (triggered)	
15.13	701	Flexible analog limit 13 (triggered)	
15.14	702	Flexible analog limit 14 (triggered)	
15.15	703	Flexible analog limit 15 (triggered)	
15.16	704	Flexible analog limit 16 (triggered)	
15.17	705	Flexible analog limit 17 (triggered)	
15.18	706	Flexible analog limit 18 (triggered)	
15.19	707	Flexible analog limit 19 (triggered)	
15.20	708	Flexible analog limit 20 (triggered)	
15.21	709	Flexible analog limit 21 (triggered)	
15.22	710	Flexible analog limit 22 (triggered)	
15.23	711	Flexible analog limit 23 (triggered)	
15.24	712	Flexible analog limit 24 (triggered)	
15.25	713	Flexible analog limit 25 (triggered)	
15.26	714	Flexible analog limit 26 (triggered)	
15.27	715	Flexible analog limit 27 (triggered)	
15.28	716	Flexible analog limit 28 (triggered)	
15.29	717	Flexible analog limit 29 (triggered)	
15.30	718	Flexible analog limit 30 (triggered)	
15.31	719	Flexible analog limit 31 (triggered)	
15.32	720	Flexible analog limit 32 (triggered)	
15.33	721	Flexible analog limit 33 (triggered)	
15.34	722	Flexible analog limit 34 (triggered)	
15.35	723	Flexible analog limit 35 (triggered)	
15.36	724	Flexible analog limit 36 (triggered)	
15.37	725	Flexible analog limit 37 (triggered)	
15.38	726	Flexible analog limit 38 (triggered)	
15.39	727	Flexible analog limit 39 (triggered)	
15.40	728	Flexible analog limit 40 (triggered)	

#### 9.4.4.17 Group 17: Alarm System 2 (VDE-AR-N 4105 & Free Alarms)

- VDE-AR-N 4105 & Free alarms
- Logic command variables 17.01-17.14

The transistor outputs may be used as command variable in a logical output.

No.	ID	Name / Function	Note
17.01	781	Reserved	
17.02	782	Reserved	
17.03	783	Reserved	
17.04	784	Reserved	
17.05	785	Missing member 4105	
17.06	786	Para.alignment 4105	Parameters are aligned to VDE-AR-N 4105 conditions
17.07	787	Meas.difference 4105	Measuring difference detected according to VDE-AR-N 4105
17.08	788	Decoupling GCB/MCB	
17.10	790	Max. starts per time unit	
17.11	791	Free alarm 1	
17.12	792	Free alarm 2	
17.13	793	Free alarm 3	
17.14	794	Free alarm 4	

#### 9.4.4.18 Group 18: Transistor Outputs

- Transistor outputs
- Logic command variables 18.01-18.04

The transistor outputs may be used as command variable in a logical output.

No.	ID	Name / Function	Note
18.01	813	Reserved	
18.02	814	Reserved	
18.03	815	D+ charge alternator 12 Volt feature active	TRUE as long as the starter relay is energized and the power supply voltage is below 16 V
18.04	816	D+ charge alternator 24 Volt feature active	TRUE as long as the starter relay is energized and the power supply voltage exceeds 16 V

**9.4.4.19 Group 22: External Discrete Inputs 2**

- External discrete inputs 2
- Logic command variables 22.01-22.16
-  No. 22.01..22.16 "External discrete input D.E17-32 are available at package 2 only.

Additional discrete inputs from an expansion board (i.e. IKD 1 extension board) may be used as command variable in a logical output.

No.	ID	Name / Function	Note
22.01	833	External discrete input 17 [D.E17]	TRUE = logical "1" (delay times and N.O./N.C. parameters are ignored)  FALSE = logical "0" (alarm has been acknowledged, or immediately after TRUE condition is not present anymore, if Control is configured as alarm class)
22.02	834	External discrete input 18 [D.E18]	
22.03	835	External discrete input 19 [D.E19]	
22.04	836	External discrete input 20 [D.E20]	
22.05	837	External discrete input 21 [D.E21]	
22.06	838	External discrete input 22 [D.E22]	
22.07	839	External discrete input 23 [D.E23]	
22.08	840	External discrete input 24 [D.E24]	
22.09	841	External discrete input 25 [D.E25]	
22.10	842	External discrete input 26 [D.E26]	
22.11	843	External discrete input 27 [D.E27]	
22.12	844	External discrete input 28 [D.E28]	
22.13	845	External discrete input 29 [D.E29]	
22.14	846	External discrete input 30 [D.E30]	
22.15	847	External discrete input 31 [D.E31]	
22.16	847	External discrete input 32 [D.E32]	

Table 104:

**9.4.4.20 Group 23: External Discrete Outputs 2**

- External discrete outputs 2
- Logic command variables 23.01-23.16
-  No. 23.01..22.16 "External discrete output R.E17..32 are available at package 2 only.

The external discrete outputs may be used as command variable in a logical output.







No.	ID	Name / Function	Note
23.01	853	External discrete output DO17 [R.E17]	TRUE = logical "1" (this condition indicates the logical status of the relays, which are connected via external expansion boards)
23.02	854	External discrete output DO18 [R.E18]	
23.03	855	External discrete output DO19 [R.E19]	





No.	ID	Name / Function	Note
23.04	856	External discrete output DO20 [R.E20]	FALSE = logical "0" (this condition indicates the logical status of the relays, which are connected via external expansion boards)
23.05	857	External discrete output DO21 [R.E21]	
23.06	858	External discrete output DO22 [R.E22]	
23.07	859	External discrete output DO23 [R.E23]	
23.08	860	External discrete output DO24 [R.E24]	
23.09	861	External discrete output DO25 [R.E25]	
23.10	862	External discrete output DO26 [R.E26]	
23.11	863	External discrete output DO27 [R.E27]	
23.12	864	External discrete output DO28 [R.E28]	
23.13	865	External discrete output DO29 [R.E29]	
23.14	866	External discrete output DO30 [R.E30]	
23.15	867	External discrete output DO31 [R.E31]	
23.16	868	External discrete output DO32 [R.E32]	

#### 9.4.4.21 Group 24: Flags Condition 2

- Flags condition 2
- Logic command variables 24.01..24.60
-  P2: No. 24.01..24.16 "LM: External relay DO17..32" and No. 24.17..24.19 "LM: PID..." are applicable with package 2 only.

No.	ID	Name	Function	Note
24.01	873	 P2: LM: External relay DO 17		TRUE, if the LogicsManager condition driving this relay is fulfilled
24.02	874	 P2: LM: External relay DO 18		
24.03	875	 P2: LM: External relay DO 19		
24.04	876	 P2: LM: External relay DO 20		
24.05	877	 P2: LM: External relay DO 21		
24.06	878	 P2: LM: External relay DO 22		
24.07	879	 P2: LM: External relay DO 23		
24.08	880	 P2: LM: External relay DO 24		
24.09	881	 P2: LM: External relay DO 25		
24.10	882	 P2: LM: External relay DO 26		
24.11	883	 P2: LM: External relay DO 27		
24.12	884	 P2: LM: External relay DO 28		
24.13	885	 P2: LM: External relay DO 29		
24.14	886	 P2: LM: External relay DO 30		

No.	ID	Name	Function	Note
24.15	887	 LM: External relay DO 31		
24.16	888	 LM: External relay DO 32		
24.17	889	 LM: PID1 ctrl.release	Enables PID 1 control	Internal calculation Refer to parameter 5580 ↗ p. 348.
24.18	890	 LM: PID2 ctrl.release	Enables PID 2 control	Internal calculation Refer to parameter 5593 ↗ p. 348.
24.19	891	 LM: PID3 ctrl.release	Enables PID 3 control	Internal calculation Refer to parameter 5679 ↗ p. 348.
24.20	892	LM: Unit1 call requ.		TRUE, if the LogicsManager condition driving this relay is fulfilled
24.21	893	LM: Unit2 call requ.		
24.22	894	LM: Unit3 call requ.		
24.23 .. 24.45	895 .. 917	Reserved		
24.46	918	LM: GCB open in MAN		TRUE, if the LogicsManager condition is fulfilled (LM: 12976)
24.47	919	LM: GCB close in MAN		TRUE, if the LogicsManager condition is fulfilled (LM: 12977)
24.48	920	LM: MCB open in MAN		TRUE, if the LogicsManager condition is fulfilled (LM: 12974)
24.49	921	LM: MCB close in MAN		TRUE, if the LogicsManager condition is fulfilled (LM: 12975)
24.50	922	LM: MAN engine start		TRUE, if the LogicsManager condition is fulfilled (LM: 12970)
24.51 .. 24.58	923 .. 930	Reserved		
24.59	931	LM: MAN engine stop		TRUE, if the LogicsManager condition is fulfilled (LM: 12971)
24.60	932	LM: Free derating		TRUE, if the LogicsManager condition is fulfilled (LM: 15146)
24.61 .. 24.75	933 .. 947	Reserved		
24.76	948	24.76 LM Enable test ramp status		TRUE, if the LogicsManager condition is fulfilled (LM: 11465)

9.4.4.22 Group 25: Ext. Analog inputs

-  Ext. AI1-16 are available at package 2 only.
- Ext. analog inputs
- Logic command variables 25.01-25.16

No.	ID	Name	Function	Note
25.01	972	Ext. AI 1 wire break-status		TRUE, if wire break of dedicated ext. analog input is recognized
25.02	973	Ext. AI 2 wire break-status		
25.03	974	Ext. AI 3 wire break-status		
25.04	975	Ext. AI 4 wire break-status		
25.05	976	Ext. AI 5 wire break-status		
25.06	977	Ext. AI 6 wire break-status		
25.07	978	Ext. AI 7 wire break-status		
25.08	979	Ext. AI 8 wire break-status		
25.09	980	Ext. AI 9 wire break-status		
25.10	981	Ext. AI 10 wire break-status		
25.11	982	Ext. AI 11 wire break-status		
25.12	983	Ext. AI 12 wire break-status		
25.13	984	Ext. AI 13 wire break-status		
25.14	985	Ext. AI 14 wire break-status		
25.15	986	Ext. AI 15 wire break-status		
25.16	987	Ext. AI 16 wire break-status		

9.4.5 Factory Settings

Functions

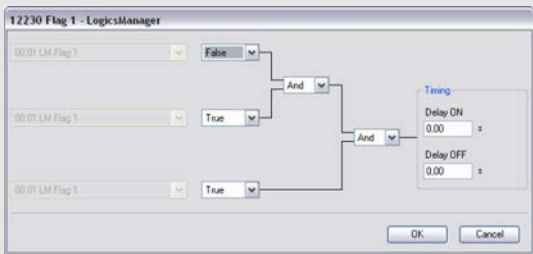
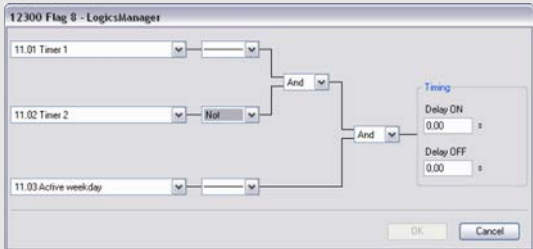
Simple (function)	Extended (configuration)	Result
<p><b>[00.0x] Flag {x}; {x} = 1 to 7</b></p> <p>If TRUE, flag {x} becomes TRUE.</p> <p>Deactivated by default.</p>		FALSE
<p><b>[00.08] Flag 8 - pre-configured to engine start via timer</b></p>		dependent on timer

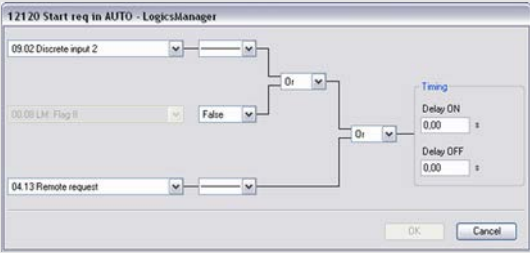
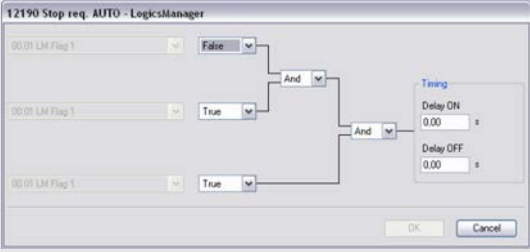
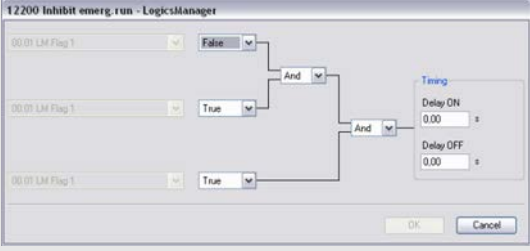
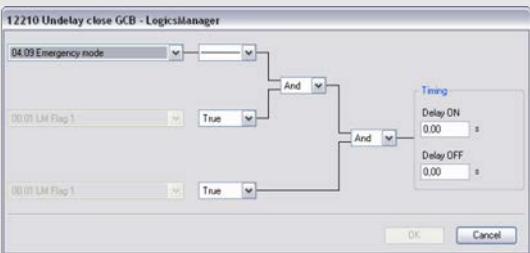
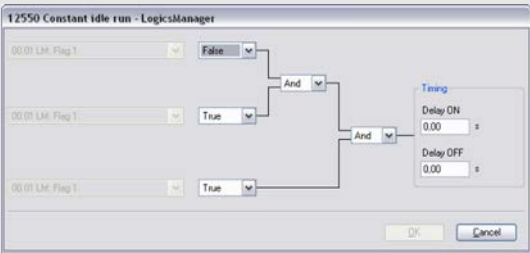
Simple (function)	Extended (configuration)	Result
<p>If TRUE, flag 8 becomes TRUE.</p> <p>TRUE once the configured time 1 has been reached [11.01], and the configured time 2 [11.02] has not been reached as well if the current day is the configured day [11.03] ( ↩ Chapter 4.7 "Configure LogicsManager" on page 375)</p> <p>Not available in operating modes "STOP" and "MAN"</p>		
<p><b>[00.09] Start request in Auto</b></p> <p>If TRUE, the engine is started in AUTOMATIC operating mode.</p> <p>TRUE once discrete input [DI 02] is energized.</p> <p>Note: This function is pre-configured and may be activated by passing through the command variables [00.08] LM: Flag 8 or [04.03] Remote request ('-' instead of '0').</p> <p>Not available in operating modes "STOP" and "MAN".</p>		<p>dependent on [DI 02]</p>
<p><b>[00.10] Stop request in Auto</b></p> <p>If TRUE, the engine is either stopped in AUTOMATIC operating mode or a start of the engine is suppressed (also an emergency operation).</p> <p>Deactivated by default.</p> <p>Not available in operating modes "STOP" and "MAN".</p>		<p>FALSE</p>
<p><b>[00.11] Inhibit emergency run</b></p> <p>If TRUE, an emergency operation is inhibited or interrupted.</p> <p>Deactivated by default.</p> <p>Not available in operating modes "STOP" and "MAN". Only available in application mode <b>A04</b>.</p>		<p>FALSE</p>
<p><b>[00.12] Undelay close GCB</b></p> <p>If TRUE, the GCB will be closed in an emergency operation without waiting for expiration of the delayed engine monitoring.</p> <p>TRUE once emergency mode is enabled.</p> <p>Only available in application mode <b>A03</b>, <b>A04</b> and operating modes "AUTO" and "MAN".</p>		<p>dependent on emergency operation</p>
<p><b>[00.14] Constant Idle run</b></p> <p>If TRUE, the control outputs an "Constant idle run" if a start request for the generator is present</p> <p>Deactivated by default.</p>		<p>FALSE</p>

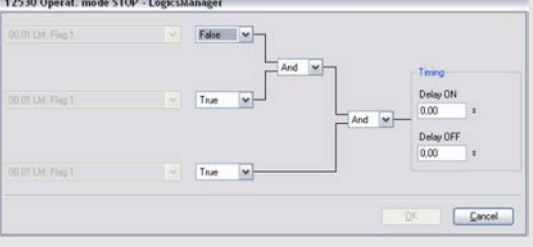
Simple (function)	Extended (configuration)	Result
<p><b>[00.15] External acknowledgment</b></p> <p>If TRUE, all alarms are acknowledged from an external source.</p> <p>TRUE once discrete input [DI 05] is energized.</p>		<p>dependent on discrete input [DI 05]</p>
<p><b>[00.16] Operation mode AUTOMATIC</b></p> <p>If TRUE the unit changes into AUTOMATIC operating mode.</p> <p>Deactivated by default.</p>		<p>FALSE</p>
<p><b>[00.17] Operation mode MANUAL</b></p> <p>If TRUE the unit changes into MANUAL operating mode.</p> <p>Deactivated by default.</p>		<p>FALSE</p>
<p><b>[00.18] Operation mode STOP</b></p> <p>If TRUE the unit changes into STOP operating mode.</p> <p>Deactivated by default.</p>		<p>FALSE</p>
<p><b>[00.19] Start without load</b></p> <p>If TRUE, the engine is started without load transfer to the generator (closing the GCB is blocked).</p> <p>Deactivated by default.</p>		<p>FALSE</p>
<p><b>[00.20] Automatic Idle mode</b></p> <p>If TRUE, the control performs an idle run for a configured time at start-up.</p> <p>Deactivated by default.</p> <p><b>Note</b></p> <p>This function is pre-configured and may be activated by passing through the command variable [00.09] Start req. in Auto ('-' instead of '0').</p>		<p>FALSE</p>

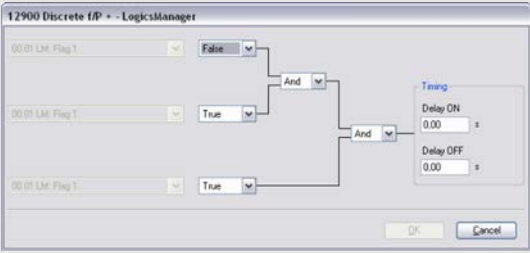
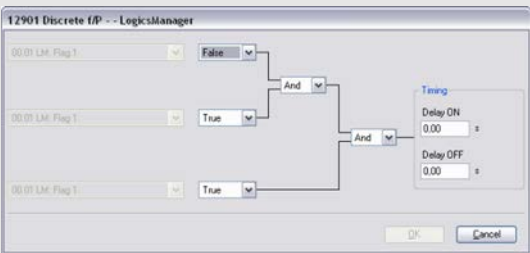
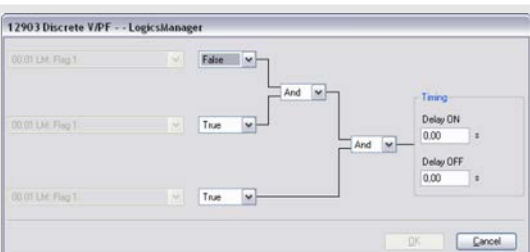
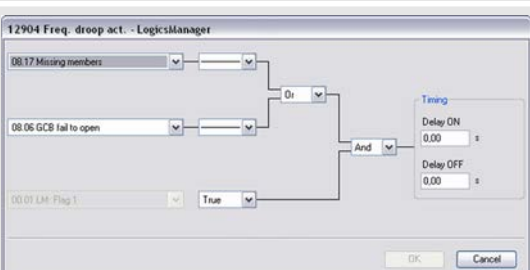
Simple (function)	Extended (configuration)	Result
<p><b>[00.21] Raise frequency/load setpoint</b></p> <p>If TRUE, the frequency/load setpoint will be raised.</p> <p>Deactivated by default.</p>		FALSE
<p><b>[00.22] Lower frequency/load setpoint</b></p> <p>If TRUE, the frequency/load setpoint will be lowered.</p> <p>Deactivated by default.</p>		FALSE
<p><b>[00.23] Raise voltage/power factor setpoint</b></p> <p>If TRUE, the voltage/power factor setpoint will be raised.</p> <p>Deactivated by default.</p>		FALSE
<p><b>[00.24] Lower voltage/power factor setpoint</b></p> <p>If TRUE, the voltage/power factor setpoint will be lowered.</p> <p>Deactivated by default.</p>		FALSE
<p><b>[00.25] Frequency droop active</b></p> <p>If TRUE, the frequency droop is enabled.</p> <p>TRUE once missing members are detected on the load share bus.</p> <p>Not available in operating mode "STOP".</p>		dependent on missing members
<p><b>[00.26] Voltage droop active</b></p> <p>If TRUE, the voltage droop is enabled.</p> <p>TRUE once missing members are detected on the load share bus.</p> <p>Not available in operating mode "STOP".</p>		dependent on missing members

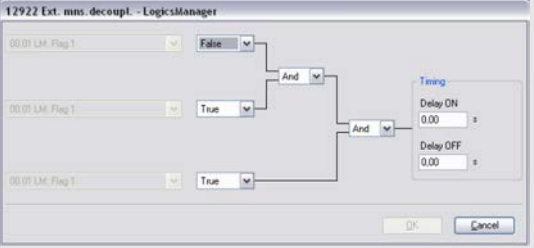
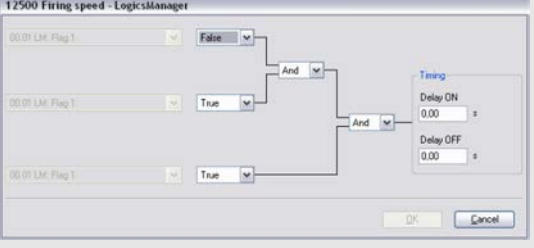
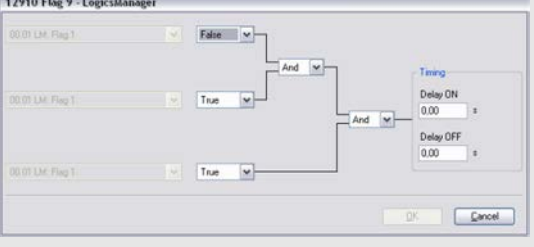
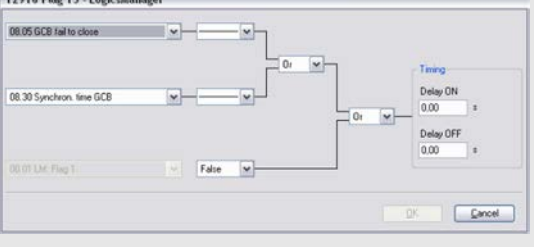
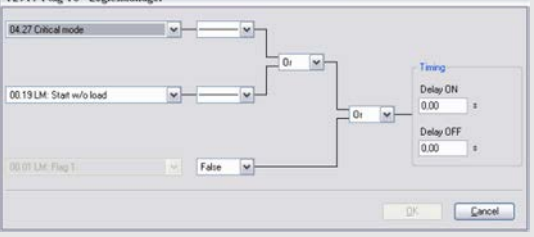
Simple (function)	Extended (configuration)	Result
<p><b>[00.27] External mains decoupling</b></p> <p>If TRUE, a mains failure is requested by an external device.</p> <p>Deactivated by default</p> <p>Not available in operation modes "STOP" and "MAN".</p>		<p>FALSE</p>
<p><b>[00.28] Critical mode</b></p> <p>If TRUE, the control performs a critical mode operation.</p> <p>Deactivated by default.</p> <p>TRUE, if no start failure is present and/or discrete input [DI 01] is not energized.</p> <p>Not available in operation modes "STOP" and "MAN".</p>		<p>dependent on start failure and [DI 01]</p>
<p><b>[00.29] Firing speed reached</b></p> <p>If TRUE, the unit recognizes that the ignition speed has been reached.</p> <p>Deactivated by default.</p>		<p>FALSE</p>
<p><b>[00.3x] Flag {y}; {x} = 0 to 5, {y} = 9 to 14</b></p> <p>If TRUE, flag {y} becomes TRUE.</p> <p>Deactivated by default</p> <p>Not available in operation modes "STOP" and "MAN".</p>		<p>FALSE</p>
<p><b>[00.36] Flag 15</b></p> <p>If TRUE, flag 15 becomes TRUE.</p> <p>Prepared for GCB fail to close or Synchronization time GCB.</p> <p>Not available in operating modes "STOP" and "MAN".</p>		<p>dependent on GCB fail to close and Synchronization time GCB</p>
<p><b>[00.37] Flag 16</b></p> <p>If TRUE, flag 16 becomes TRUE.</p> <p>Prepared for Critical mode or Start without load.</p> <p>Not available in operating modes "STOP" and "MAN".</p>		<p>dependent on Critical mode and Start without load</p>

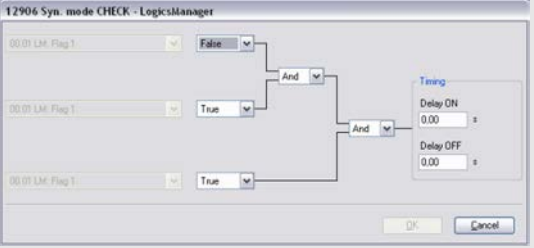
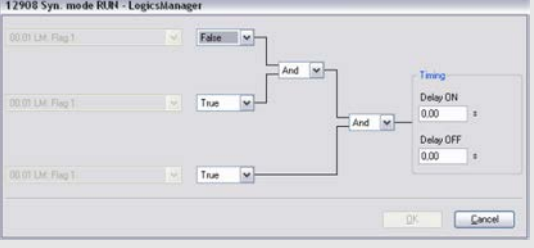
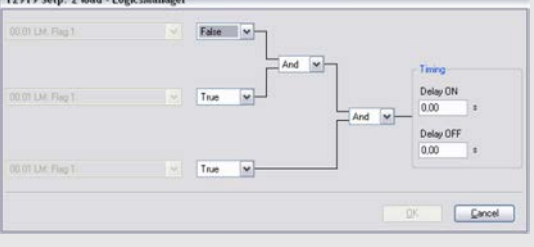
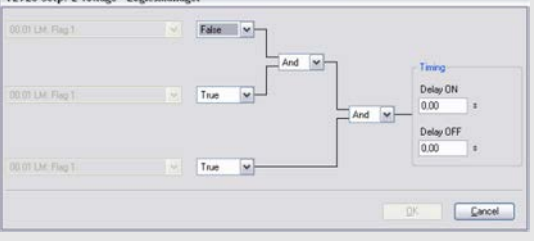
Simple (function)	Extended (configuration)	Result
<p><b>[00.38] Synchronization mode CHECK</b></p> <p>If TRUE, the CHECK synchronization mode is enabled.</p> <p>Deactivated by default.</p> <p>Only available in operating mode "AUTO" and application mode <b>A03</b>, <b>A04</b>.</p>		FALSE
<p><b>[00.39] Synchronization mode PERMISSIVE</b></p> <p>If TRUE, the PERMISSIVE synchronization mode is enabled.</p> <p>Deactivated by default.</p> <p>Only available in operating mode "AUTO" and application mode <b>A03</b>, <b>A04</b>.</p>		FALSE
<p><b>[00.40] Synchronization mode RUN</b></p> <p>If TRUE, the RUN synchronization mode is enabled.</p> <p>Deactivated by default.</p> <p>Only available in operating mode "AUTO" and application mode <b>A03</b>, <b>A04</b>.</p>		FALSE
<p><b>[00.81] Setpoint 2 frequency enabled</b></p> <p>If TRUE, the frequency setpoint 2 is enabled.</p> <p>Deactivated by default.</p> <p>Not available in operating modes "STOP" and "MAN".</p>		FALSE
<p><b>[00.82] Setpoint 2 load enabled</b></p> <p>If TRUE, the load setpoint 2 is enabled.</p> <p>Deactivated by default.</p> <p>Not available in operating modes "STOP" and "MAN".</p>		FALSE
<p><b>[00.83] Setpoint 2 voltage enabled</b></p> <p>If TRUE, the voltage setpoint 2 is enabled.</p> <p>Deactivated by default.</p> <p>Not available in operating modes "STOP" and "MAN".</p>		FALSE

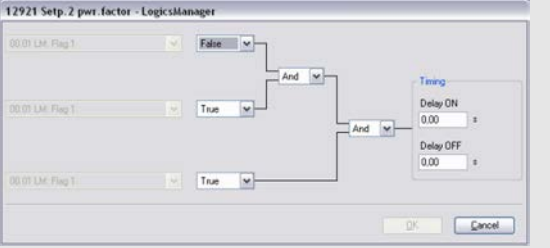
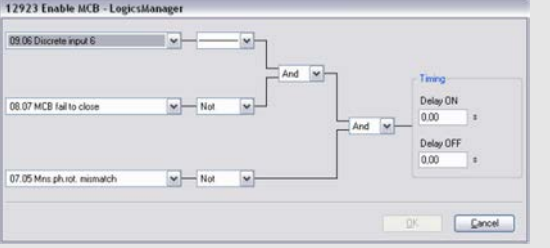
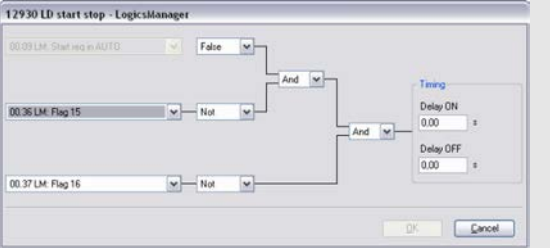
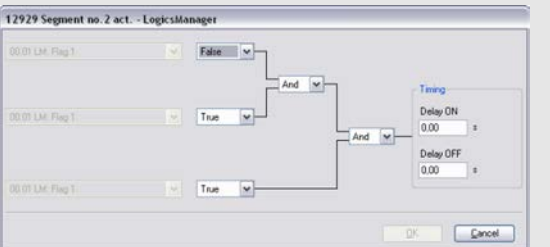
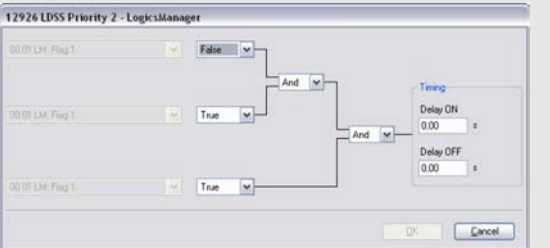
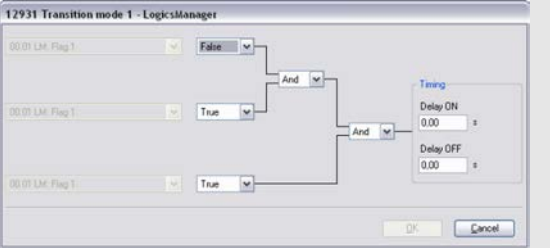

Simple (function)	Extended (configuration)	Result
<p><b>[00.84] Setpoint 2 power factor enabled</b></p> <p>If TRUE, the power factor setpoint 2 is enabled.</p> <p>Deactivated by default.</p> <p>Not available in operating modes "STOP" and "MAN".</p>		<p>FALSE</p>
<p><b>[00.85] Enable MCB</b></p> <p>If TRUE, the MCB is enabled.</p> <p>TRUE, if discrete input [DI 06] is energized and/or MCB did not fail to close and/or no mains phase rotation mismatch is detected.</p> <p>Only available in operating mode "AUTO" and application mode <b>A03</b>, <b>A04</b>.</p>		<p>dependent on [DI 06] and MCB closure and mains phase rotation</p>
<p><b>[00.86] Load-dependent start/stop</b></p> <p>If TRUE, load-dependent start/stop is enabled.</p> <p>Deactivated by default.</p> <p>Prepared for start request in AUTO and neither Flag 15 nor Flag 16 are enabled.</p> <p>Only available in operating mode "AUTO" and application mode <b>A03</b>, <b>A04</b>.</p>		<p>FALSE</p>
<p><b>[00.8x] Segment no. {y} active; {x} = 7 to 9; {y} = 2 to 4</b></p> <p>If TRUE, load-dependent start/stop segment no.{y} is enabled.</p> <p>Deactivated by default.</p> <p>Only available in operating mode "AUTO" and application mode <b>A03</b>, <b>A04</b>.</p>		<p>FALSE</p>
<p><b>[00.9x] LDSS Priority {y}; {x} = 0 to 2; {y} = 2 to 4</b></p> <p>If TRUE, load-dependent start/stop priority {y} is enabled.</p> <p>Deactivated by default.</p> <p>Only available in operating mode "AUTO" and application mode <b>A03</b>, <b>A04</b>.</p>		<p>FALSE</p>
<p><b>[00.9x] Transition mode {y}; {x} = 3 to 4; {y} = 1 to 2</b></p> <p>If TRUE, transition mode {x} is enabled.</p> <p>Deactivated by default.</p> <p>Only available in operating mode "AUTO" and application mode <b>A04</b>.</p>		<p>FALSE</p>

Simple (function)	Extended (configuration)	Result
<p><b>[24.1x] PID{y} ctrl. release; {x} = 7 to 9; {y} = 1 to 3</b></p> <p>If TRUE, PID {y} control is released.</p> <p>Deactivated by default.</p> <p>Not available in operating modes "STOP" and "MAN".</p>		<p>FALSE</p>

**Relay outputs**

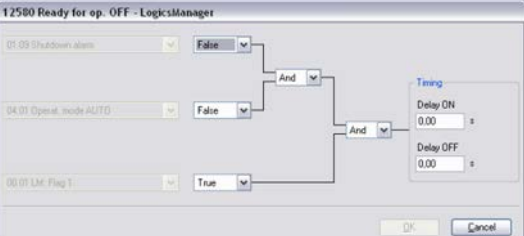
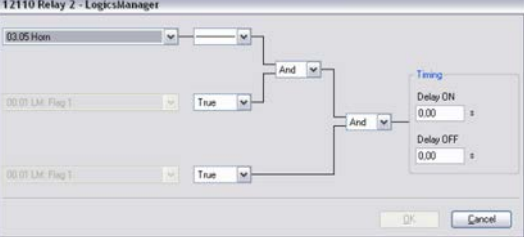
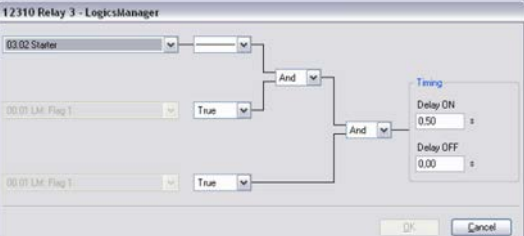
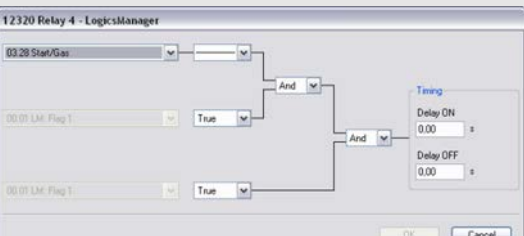
Simple (function)	Extended (configuration)	Result
<p><b>[00.41] Relay 1 [R01] - Ready for operation OFF</b></p> <p>Relay will be de-energized if unit is not ready for operation or the LogicsManager output is TRUE.</p> <p>Deactivated by default</p> <p>Note: This function is pre-configured and may be activated by passing through the command variables [01.09] Shutdown alarm or [04.01] Operating mode AUTO or [00.01] LM: Flag 1 ('-' instead of '0').</p> <p>The unit is only ready for operation after an start-up delay following the power supply connection.</p>		<p>FALSE</p>
<p><b>[00.42] Relay 2 [R02] - Centralized alarm (horn) / freely configurable</b></p> <p>Relay energizes if the internal condition "Horn" is TRUE</p>		<p>dependent on Logics Command Variable [03.05]</p>
<p><b>[00.43] Relay 3 [R03] - Starter / freely configurable</b></p> <p>Relay energizes if the internal condition "Starter" is TRUE</p>		<p>dependent on Logics Command Variable [03.02]</p>
<p><b>[00.44] Relay 4 [R04] - Start/Gas / freely configurable</b></p> <p>Relay energizes if the internal condition "Start/Gas" is TRUE to energize the start (Diesel) or gas (Gas) solenoid</p>		<p>dependent on Logics Command Variable [03.28]</p>

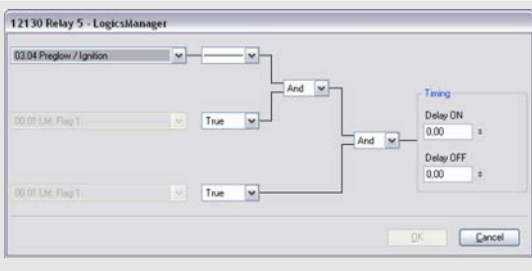
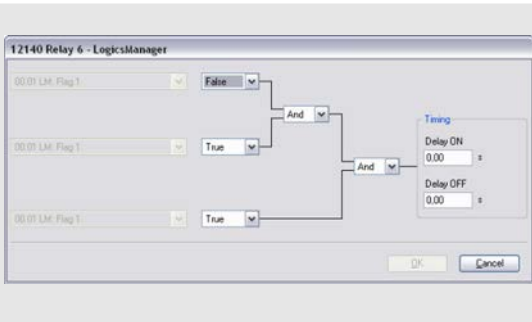
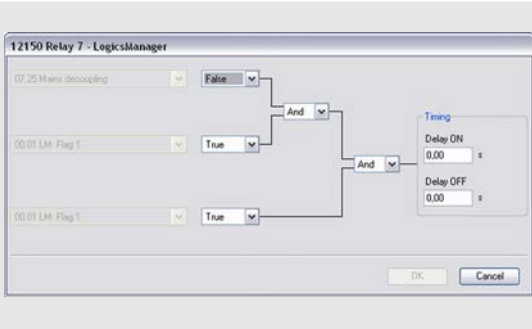
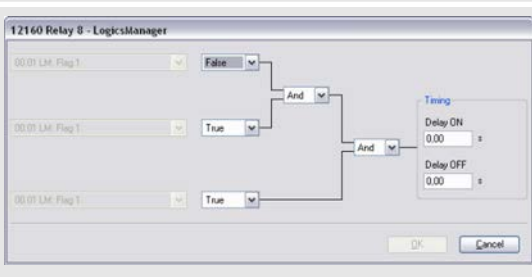
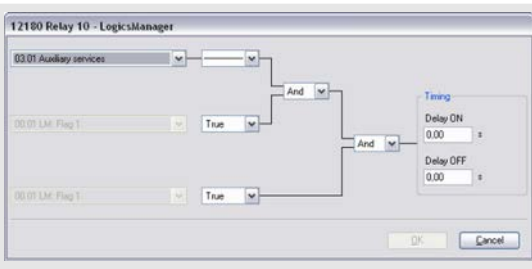
Simple (function)	Extended (configuration)	Result
<p><b>[00.45] Relay 5 [R05] - Preglow / Ignition / freely configurable</b></p> <p>Relay energizes if the internal condition "Preglow / Ignition" is TRUE to preglow the Diesel engine or enabling the ignition of the gas engine</p>		<p>dependent on Logics Command Variable [03.04]</p>
<p><b>[00.46] Relay 6 [R06] - Free / Command: close GCB</b></p> <p>In application mode <b>A01</b> and <b>A02</b> = freely configurable relay (unassigned)</p> <p>In application mode <b>A03</b> and <b>A04</b> "Command: close GCB"</p> <p>Deactivated by default</p>		<p>FALSE</p>
<p><b>[00.47] Relay 7 [R07] - Mains decoupling / freely configurable / Command: open GCB</b></p> <p>In application mode <b>A01</b> pre-configured to mains decoupling. Relay energizes if the internal condition "Mains decoupling" is TRUE to decouple the genset from the mains.</p> <p>In application mode <b>A02</b>, <b>A03</b> and <b>A04</b> "Command: open GCB"</p> <p>Deactivated by default</p>		<p>dependent on application mode and Logics Command Variable [07.25]</p>
<p><b>[00.48] Relay 8 [R08] - Free / Command: close MCB</b></p> <p>In application mode <b>A01</b>, <b>A02</b>, and <b>A03</b> = freely configurable relay (unassigned)</p> <p>In application mode <b>A04</b> "Command: close MCB"</p> <p>Deactivated by default</p>		<p>FALSE</p>
<p><b>[00.49] Relay 9 [R09] - Mains decoupling / freely configurable / Command: open MCB</b></p> <p>In application mode <b>A01</b>, <b>A02</b>, and <b>A03</b> pre-configured to mains decoupling. Relay energizes if the internal condition "Mains decoupling" is TRUE to decouple the genset from the mains.</p> <p>"Command: open MCB"</p> <p>Deactivated by default</p>		<p>dependent on application mode and Logics Command Variable [07.25]</p>
<p><b>[00.50] Relay 10 [R10] - Auxiliary services / freely configurable</b></p> <p>Relay energizes if the internal condition "Aux. services" is TRUE to activate the auxiliary services (it energizes prior to an engine start and de-energizes with the engine stop)</p>		<p>dependent on Logics Command Variable [03.01]</p>

Simple (function)	Extended (configuration)	Result
<p><b>[00.51] Relay 11 [R11] - Warning alarm class active / freely configurable</b></p> <p>Relay energizes if one of the alarm classes A or B is active</p>		dependent on Logics Command Variable [01.08]
<p><b>[00.52] Relay 12 [R12] - Shutdown alarm class active / freely configurable</b></p> <p>Relay energizes if one of the alarm classes C, D, E or F is active</p>		dependent on Logics Command Variable [01.09]
<p><b>[00.xx] External digital output {y} - Free (external expansion card, if connected; {xx} = 63 to 78 ; {y} = 1 to 16)</b></p> <p>Control of the external relay {y}, if this is connected</p> <p>Prepared for: Deactivated by default</p>		FALSE
<p><b>[24.xx] External digital output {y} - Free (external expansion card, if connected; {xx} = 01 to 16 ; {y} = 17 to 32)</b></p> <p> easYgen-3100/3200: Package 2 only</p> <p>Control of the external relay {y}, if this is connected</p> <p>Prepared for: Deactivated by default</p>		FALSE

**Discrete inputs**

DI	Alarm class		Pre-assigned to
1	F	freely configurable	EMERGENCY STOP
2	CONTROL	freely configurable	LogicsManager Start in AUTO
3	B	freely configurable	Low oil pressure
4	B	freely configurable	Coolant temperature
5	CONTROL	freely configurable	LogicsManager External acknowledgement
6	CONTROL	freely configurable	LogicsManager Enable MCB
7		fixed	Reply MCB
8		fixed	Reply GCB

DI	Alarm class		Pre-assigned to
9	B	freely configurable	unassigned
10	B	freely configurable	unassigned
11	B	freely configurable	unassigned
12	B	freely configurable	unassigned

## 9.5 Event And Alarm Reference

### 9.5.1 Alarm Classes



*The control functions are structured in the following alarm classes:*

Alarm class	Visible in the display	LED "Alarm" & horn	Relay "Command: open GCB"	Shut-down engine	Engine blocked until ack. sequence has been performed
<b>A</b>	Yes	No	No	No	No
Warning Alarm	This alarm does not interrupt the unit operation. A message output without a centralized alarm occurs: ■ Alarm text.				
<b>B</b>	Yes	Yes	No	No	No
Warning Alarm	This alarm does not interrupt the unit operation. An output of the centralized alarm occurs and the command variable 3.05 (horn) is issued. ■ Alarm text + flashing LED "Alarm" + Relay centralized alarm (horn).				
<b>C</b>	Yes	Yes	Soft unloading	Cool down time	Yes
Shutdown Alarm	With this alarm the GCB is opened and the engine is stopped. Coasting occurs. ■ Alarm text + flashing LED "Alarm" + Relay centralized alarm (horn) + GCB open + Coasting + Engine stop.				
<b>D</b>	Yes	Yes	Immediately	Cool down time	Yes
Shutdown Alarm	With this alarm the GCB is opened and the engine is stopped. Coasting occurs. ■ Alarm text + flashing LED "Alarm" + Relay centralized alarm (horn) + GCB open + Coasting + Engine stop.				
<b>E</b>	Yes	Yes	Soft unloading	Immediately	Yes
Shutdown Alarm	With this alarm the GCB is opened immediately and the engine is stopped. ■ Alarm text + flashing LED "Alarm" + Relay centralized alarm (horn) + GCB open + Engine stop.				
<b>F</b>	Yes	Yes	Immediately	Immediately	Yes
Shutdown Alarm	With this alarm the GCB is opened immediately and the engine is stopped. ■ Alarm text + flashing LED "Alarm" + Relay centralized alarm (horn) + GCB open + Engine stop.				

Alarm class	Visible in the display	LED "Alarm" & horn	Relay "Command: open GCB"	Shut-down engine	Engine blocked until ack. sequence has been performed
Control	No	No	No	No	No
Control Signal	This signal issues a control command only. It may be assigned to a discrete input for example to get a control signal, which may be used in the LogicsManager. No alarm message and no entry in the alarm list or the event history will be issued. This signal is always self-acknowledging, but considers a delay time and may also be configured with an engine delay.				



**CAUTION!**

If an alarm of class C, D, or E is present and the GCB cannot be opened, the engine will not be stopped. This can only be achieved by enabling GCB monitoring (parameter 2600 ↪ p. 189) with the alarm class configured to "F" (parameter 2601 ↪ p. 189).

If an alarm has been configured with a shutdown alarm that has been enabled to self-acknowledge, and has been configured as engine delayed the following scenario may happen:

- The alarm shuts down the engine because of its alarm class.
- Due to the engine stopping, all engine delayed alarms are ignored.
- The alarm class is acknowledged automatically.
- The alarm will self-acknowledge and clear the fault message that shut the engine down.  
This prevents the fault from being analyzed. After a short delay, the engine will restart.
- After the engine monitoring delay expires, the fault that originally shut down the engine will do so again.  
This cycle will continue to repeat until corrected.

**9.5.2 Conversion Factors**

**Temperature**

°C → °F	$T [°F] = (T [°C] \times 1.8) + 32$
°F → °C	$T [°C] = (T [°F] - 32) / 1.8$

**Pressure**

bar → psi	$P [psi] = P [bar] \times 14.503$
psi → bar	$P [bar] = P [psi] / 14.503$

### 9.5.3 Status Messages

Message text ID	Meaning
AUTO mode ready 13253	<b>Automatic mode ready for start</b> The unit is waiting for a start signal in Automatic operating mode and no alarm of class C, D, E, or F is present.
Aux. serv. postrun 13200	<b>Postrun of the auxiliary operation is active</b> After the engine has stopped, auxiliary operations are enabled. These operations ensure that required equipment which is necessary for the operation of the engine continues to run (i.e. electric cooling fan).
Aux. services prerun 13201	<b>Prerun of the auxiliary operation is active</b> Before the engine is started the signal "aux. services prerun" is enabled, so that all required equipment which is necessary for the operation of the engine can be initialized, started or switched.
Cool down 13204	<b>Coasting of the engine is active</b> The no load operation is performed prior to the stopping of the engine. The no load operation is utilized to cool the engine.
Crank protect 13214	<b>Starter protection</b> To prevent the starter from being damaged by an engine that is rotating, a crank protection delay is active to ensure that the engine has time to stop rotating.
Critical mode 13202	<b>Critical mode (Sprinkler operation) is active</b> The sprinkler operation is activated.
Emergency/Critical 13215	<b>Emergency operation during active critical operation <b>A04</b></b> Critical operation is activated.
Emergency run 13211	<b>Emergency power operation <b>A04</b></b> After the control unit detects that a mains fault has occurred, the engine is started after the emergency delay timer expires. The MCB is opened, the GCB is closed, and the generator set assumes the load. If the generator set is already running, operations continue until the emergency power operation conditions no longer exist. If the mains return, the mains settling timer becomes active first (see below).
GCB dead bus close 13209	<b>Dead bus closing of the GCB <b>A03 A04</b></b> The GCB is closed onto the de-energized busbar. The measured busbar voltage is below the configured dead bus detection limit.
GCB → MCB Delay 13261	<b>GCB – MCB delay time is active <b>A04</b></b> If the breaker logic is configured to Open Transition and a transfer from generator to mains supply is initiated, the transfer time delay will start after the replay "GCB is open" is received. The MCB close command will be issued after the transfer time has expired.
GCB open 13255	<b>The GCB is being opened <b>A02</b></b> A GCB open command has been issued.
Gen. stable time 13250	<b>Generator stable time is active</b> If the engine monitoring delay timer has expired, the generator settling time starts. This permits for an additional delay time before the breaker is closed in order to ensure that none of the engine delayed watchdogs trips.
Idle run active 13216	<b>The control is in idle mode</b> No undervoltage, underfrequency, and underspeed monitoring is performed in idle mode. The flexible limits 33 through 40 are not monitored.
Ignition 13213	<b>Enable the ignition (Gas engine)</b> After the purging operation and before the fuel solenoid is opened.

Message text ID	Meaning
In operation 13251	<b>The genset is in regular operation</b> The genset is in regular operation and is ready for supplying load.
Loading Generator 13258	<b>The generator power will be increased to the setpoint</b> The generator power will be increased to the configured setpoint with a rate defined by the power control setpoint ramp.
Mains settling 13205	<b>Mains settling time is active <span style="background-color: #cccccc;">A04</span></b> When the control unit detects that the mains fault is no longer present and power has been restored, the mains settling timer begins counting down. If the mains are stable after the expiration of the timer (the mains voltage has not fallen below or risen over the configured monitoring limits), the load is transferred from the generator supply to the mains supply.
MCB dead bus close 13210	<b>Dead bus closing of the MCB <span style="background-color: #cccccc;">A04</span></b> The MCB is closed onto the de-energized busbar. The measured busbar voltage is below the configured dead bus detection limit.
MCB → GCB Delay 13262	<b>MCB – GCB delay time is active <span style="background-color: #cccccc;">A04</span></b> If the breaker logic is configured to Open Transition and a transfer from mains to generator supply is initiated, the transfer time delay will start after the reply "MCB is open" is received. The GCB close command will be issued after the transfer time has expired.
MCB open 13257	<b>The MCB is being opened <span style="background-color: #cccccc;">A04</span></b> An MCB open command has been issued.
Power limited prerun 13252	<b>Active power limited prerun is active</b> The real power setpoint is limited to the warm up power limit for the configured warm up time.
Preglow 13208	<b>Preglow of the engine is active (Diesel engine)</b> The diesel engine is preheated prior to starting.
Ramp to rated 13254	<b>Engine is accelerating to rated speed</b> After firing speed has been exceeded, the engine monitoring delay timer starts. This message is displayed during this period.
Start 13206	<b>Start engine is active</b> After the "Prerun auxiliary operation" expires, the engine is started according to the configured start logic (Diesel or gas engine). When the start sequence is active, various relays are enabled and representative signals are passed via the CAN bus to a secondary engine control.
Start – Pause 13207	<b>Start pause while starting the engine is active</b> If the engine could not be started, the controller will pause for the configured time prior to attempting to issuing a start command again.
Start w/o Load 13263	<b>Start without load is active</b> A regular engine start is performed. The GCB operation is blocked to prevent a change from mains to generator supply.
Stop engine 13203	<b>Engine will be stopped</b> The engine will be stopped. The engine stop delay will be started when ignition speed has been fallen below. A restart is only possible if the engine stop delay has been expired.
Synchronization GCB 13259	<b>The GCB will be synchronized</b> The control tries to synchronize the GCB.
Synchronization MCB 13260	<b>The MCB will be synchronized</b> The control tries to synchronize the MCB.



Message text ID	Meaning
Turning 13212	<b>Purging operation is active (Gas engine)</b> Before the fuel solenoid opens and the ignition of the gas engine is energized the remaining fuel, that may be present in the combustion chamber, will be removed by a purging operation. The starter turns the engine without enabling the ignition for a specified time to complete the purging operation. After the purging process, the ignition is energized.
Unloading Generator 13256	<b>The generator power will be decreased</b> The generator power will be decreased after a stop command has been issued with a rate defined by the power control setpoint ramp before the GCB will be opened.
Unloading mains 13264	<b>The mains power will be decreased</b> The real power setpoint is increased with the configured rate after synchronizing the generator in inter-change transition mode. After the mains have been unloaded, the MCB will be opened.
Synch. PERMISSIVE 13265	<b>Synchronization mode PERMISSIVE</b> If the synchronization mode is set to "PERMISSIVE" (parameter 5728 ↪ p. 233) the screen message "Synch. PERMISSIVE" is blinking on the main screen.
Synch. CHECK 13266	<b>Synchronization mode CHECK</b> If the synchronization mode is set to "CHECK" (parameter 5728 ↪ p. 233) the screen message "Synch. CHECK" is blinking on the main screen.
Synch. OFF 13267	<b>Synchronization mode OFF</b> If the synchronization mode is set to "OFF" (parameter 5728 ↪ p. 233) the screen message "Synch. OFF" is blinking on the main screen.
Add-on delay 13274	<b>Load dependent start/stop (LDSS) add-on delay time</b> Shows the current state of LDSS in the sequencing screen. A countdown of the configured add-on delay time will be displayed.
Add-off delay 13275	<b>Load dependent start/stop (LDSS) add-off delay time</b> Shows the current state of LDSS in the sequencing screen. A countdown of the configured add-off delay time will be displayed.
Minimum run time 13276	<b>Load dependent start/stop (LDSS) minimum run time</b> Shows the current state of LDSS in the sequencing screen. A countdown of the configured minimum run time will be displayed.
Derating active 13281	<b>Derating active</b> As long as the derating function is activated, this text message is shown (parameter 15143 ↪ p. 320).

## 9.5.4 Event History

### General notes

The event history is a 300 entry FIFO (First In/First Out) memory for logging alarm events and operation states of the unit. As new event messages are entered into the history, the oldest messages are deleted once 300 events have occurred.

For additional information refer to ↪ *Chapter 5 "Operation" on page 383.*

## Resetting event history

1. ➔



*Make sure to have set the appropriate code level to reset the event history.*

*If you have not entered the correct password for the required code level, the parameters for resetting the event history are not available (for additional information refer to [Chapter 4.1.6 "Password System"](#) on page 93).*

2. ➔

Reset the event history by setting the parameter "Clear eventlog" (parameter 1706 [p. 93](#)) to "Yes" via the front panel.

⇒ The complete event history is now being cleared.

### 9.5.4.1 Event Messages

Message text ID	Meaning
AUTO mode 14353	AUTO mode
STOP mode 14354	STOP mode
MAN mode 14355	MAN mode
MCB open 14700	MCB open
MCB close 14701	MCB close
GCB open 14702	GCB open
GCB close 14703	GCB close
Mains failure 14704	Mains failure
Emergency run 14705	Emergency run
Engine is running 14706	Engine is running
Critical mode 14707	Critical mode
Start up power 14778	Start up power

Message text ID	Meaning
Neutral cont. opened 1842	Neutral control opened
Neutral cont. closed 1843	Neutral control closed
Loading *.wset 1845	Loading *.wset file
Derating power act. 16192	Derating power active
Power uprating act. 16193	Power uprating active

#### 9.5.4.2 Alarm Messages



*For a detailed description of the monitoring functions, which trigger the alarm messages, refer to [Chapter 4.4](#) "Configure Monitoring" on page 109.*

Message text ID	Meaning
Amber warning lamp 15126	<b>Amber warning lamp, J1939 interface</b> This watchdogs monitors, whether a specific alarm bit is received from the CAN J1939 interface. This enables to configure the control in a way that a reaction is caused by this bit (e.g. warning, shutdown). No alarm can be indicated if the CAN communication fails.
Bat. overvoltage 1 10007	<b>Battery overvoltage, limit value 1</b> The battery voltage has exceeded the limit value 1 for battery overvoltage for at least the configured time and does not fall below the value of the hysteresis.
Bat. overvoltage 2 10008	<b>Battery overvoltage, limit value 2</b> The battery voltage has exceeded the limit value 2 for battery overvoltage for at least the configured time and does not fall below the value of the hysteresis.
Bat. undervoltage 1 10005	<b>Battery undervoltage, limit value 1</b> The battery voltage has fallen below the limit value 1 for battery undervoltage for at least the configured time and has not exceeded the value of the hysteresis.
Bat. undervoltage 2 10006	<b>Battery undervoltage, limit value 2</b> The battery voltage has fallen below the limit value 2 for battery undervoltage for at least the configured time and has not exceeded the value of the hysteresis.
CAN bus overload 10089	<b>CAN bus overload alarm</b> The sum of CAN bus messages on all can buses together exceeds 32 messages per 20 ms.

Message text ID	Meaning
CAN fault J1939 10017	<b>Interface alarm J1939</b> The communication with the ECU via the CAN bus interface is detected as interrupted because no data can be transmitted or received over the bus within the configured time.
CANopen Interface 1 10087	<b>Interface alarm CANopen on CAN bus 1</b> No Receive Process Data Object ( RPDO) is received within the configured time.
CANopen Interface 2 10088	<b>Interface alarm CANopen on CAN bus 2</b> No message is received from the external expansion board (Node-ID) within the configured time.
Charge alt. low volt 4056	<b>Charging alternator voltage low</b> The charging alternator voltage has fallen below the critical limit for at least the configured time and has not exceeded the value of the hysteresis (the critical limit is 9 V for 12 V systems and 20 V for 24 V systems).
Eng. stop malfunct. 2504	<b>Stop alarm of the engine</b> The engine failed to stop when given the stop command. When a stop command is issued a timer starts a countdown. If speed is still detected when this timer expires the controller recognizes an unsuccessful stop of the engine. An unsuccessful stop of the engine is determined if speed (measured by the generator frequency, the MPU, or the LogicsManager "ignition speed") is detected within the configured time after the stop signal has been issued.
EEPROM failure 1714	<b>The EEPROM checksum is corrupted</b> The EEPROM check at startup has resulted a defective EEPROM.
GCB fail to close 2603	<b>GCB failed to close</b> The easYgen has attempted to close the GCB the configured maximum number of attempts and failed. Depending on the configuration, the easYgen will continue to attempt to close the GCB as long as the conditions for closing the GCB are fulfilled.
GCB fail to open 2604	<b>GCB failed to open</b> The easYgen is still receiving the reply "GCB closed" after the GCB open monitoring timer has expired.
GCB syn. timeout 3064	<b>GCB synchronization time exceeded</b> The easYgen has failed to synchronize the GCB within the configured synchronization time.
Gen act. pwr mismatch 2924	<b>Generator active power mismatch</b> The deviation between the generator power and the active power setpoint has exceeded the limit for at least the configured time.
Gen. PF lagging 1 2337	<b>Generator overexcited, limit value 1</b> The power factor limit 1 has been exceeded at the generator towards inductive (i.e. the current is lagging) for at least the configured time and does not fall below the value of the hysteresis.
Gen. PF lagging 2 2338	<b>Generator overexcited, limit value 2</b> The power factor limit 2 has been exceeded at the generator towards inductive (i.e. the current is lagging) for at least the configured time and does not fall below the value of the hysteresis.
Gen. PF leading 1 2387	<b>Generator underexcited, limit value 1</b> The power factor limit 1 has fallen below at the generator towards capacitive (i.e. the current is leading) for at least the configured time and does not exceed the value of the hysteresis.
Gen. PF leading 2 2388	<b>Generator underexcited, limit value 2</b> The power factor limit 2 has fallen below at the generator towards capacitive (i.e. the current is leading) for at least the configured time and does not exceed the value of the hysteresis.

Message text ID	Meaning
Gen. overcurrent 1 2218	<b>Generator overcurrent, limit value 1</b> The generator current has exceeded the limit value 1 for the generator overcurrent for at least the configured time and does not fall below the value of the hysteresis.
Gen. overcurrent 2 2219	<b>Generator overcurrent, limit value 2</b> The generator current has exceeded the limit value 2 for the generator overcurrent for at least the configured time and does not fall below the value of the hysteresis.
Gen. overcurrent 3 2220	<b>Generator overcurrent, limit value 3</b> The generator current has exceeded the limit value 3 for the generator overcurrent for at least the configured time and does not fall below the value of the hysteresis.
Gen. overfrequency 1 1912	<b>Generator overfrequency, limit value 1</b> The generator frequency has exceeded the limit value 1 for generator overfrequency for at least the configured time and does not fall below the value of the hysteresis.
Gen. overfrequency 2 1913	<b>Generator overfrequency, limit value 2</b> The generator frequency has exceeded the limit value 2 for generator overfrequency for at least the configured time and does not fall below the value of the hysteresis.
Gen. overload IOP 1 2314	<b>Generator overload IOP, limit value 1</b> The generator power has exceeded the limit value 1 for generator overload in isolated operation (MCB is open) for at least the configured time and does not fall below the value of the hysteresis.
Gen. overload IOP 2 2315	<b>Generator overload IOP, limit value 2</b> The generator power has exceeded the limit value 2 for generator overload in isolated operation (MCB is open) for at least the configured time and does not fall below the value of the hysteresis.
Gen. overload MOP 1 2362	<b>Generator overload MOP, limit value 1</b> The generator power has exceeded the limit value 1 for generator overload in mains parallel operation (GCB and MCB are closed) for at least the configured time and does not fall below the value of the hysteresis.
Gen. overload MOP 2 2363	<b>Generator overload MOP, limit value 2</b> The generator power has exceeded the limit value 2 for generator overload in mains parallel operation (GCB and MCB are closed) for at least the configured time and does not fall below the value of the hysteresis.
Gen. overvoltage 1 2012	<b>Generator overvoltage, limit value 1</b> The generator voltage has exceeded the limit value 1 for generator overvoltage for at least the configured time and does not fall below the value of the hysteresis.
Gen. overvoltage 2 2013	<b>Generator overvoltage, limit value 2</b> The generator voltage has exceeded the limit value 2 for generator overvoltage for at least the configured time and does not fall below the value of the hysteresis.
Gen. rev/red. pwr. 1 2262	<b>Generator reverse power, limit value 1 / Generator reduced power, limit value 1</b> The generator power has exceeded the limit value 1 for generator reverse power / generator reduced power for at least the configured time and does not fall below the value of the hysteresis.
Gen. rev/red. pwr. 2 2263	<b>Generator reverse power, limit value 2 / Generator reduced power, limit value 2</b> The generator power has exceeded the limit value 2 for generator reverse power / generator reduced power for at least the configured time and does not fall below the value of the hysteresis.
Gen. ph. rot. mismatch 3955	<b>Generator rotating field mismatch</b> The generator rotating field does not correspond with the configured direction.

Message text ID	Meaning
Gen. underfrequency 1 1962	<b>Generator underfrequency, limit value 1</b> The generator frequency has fallen below the limit value 1 for generator underfrequency for at least the configured time and has not exceeded the value of the hysteresis. Additionally, the alarm has not been acknowledged (unless the "Self acknowledgement" is configured YES).
Gen. underfrequency 2 1963	<b>Generator underfrequency, limit value 2</b> The generator frequency has fallen below the limit value 2 for generator underfrequency for at least the configured time and has not exceeded the value of the hysteresis.
Gen. undervoltage 1 2062	<b>Generator undervoltage, limit value 1</b> The generator voltage has fallen below the limit value 1 for generator undervoltage for at least the configured time and has not exceeded the value of the hysteresis.
Gen. undervoltage 2 2063	<b>Generator undervoltage, limit value 2</b> The generator voltage has fallen below the limit value 2 for generator undervoltage for at least the configured time and has not exceeded the value of the hysteresis.
Gen unloading fault 3124	<b>Generator unloading mismatch</b> The easYgen failed to reduce the generator power below the configured unload limit within the configured time.
Gen. volt. asymmetry 3907	<b>Voltage asymmetry</b> The generator phase-to-phase voltages have higher differences between each other than the configured limit value.
Ground fault 1 3263	<b>Generator ground current, limit value 1</b> The measured or calculated ground current has exceeded the limit value 1 for the generator ground current for at least the configured time and does not fall below the value of the hysteresis.
Ground fault 2 3264	<b>Generator ground current, limit value 2</b> The measured or calculated ground current has exceeded the limit value 2 for the generator ground current for at least the configured time and does not fall below the value of the hysteresis.
Inv. time overcurr. 4038	<b>Generator inverse time-overcurrent</b> Current monitoring with tripping time depending on the measured current. The higher the current is the faster the tripping time according to a defined curve. According to IEC 255 three different characteristics are available: normal, highly, and extremely inverse.
Mains decoupling 3114	<b>Mains decoupling is initiated</b> One or more monitoring function(s) considered for the mains decoupling functionality has triggered.
Mains export power 1 3241	<b>Mains export power, limit value 1</b> The mains export power has exceeded or fallen below the limit value 1 for mains export power for at least the configured time and does not fall below or exceed the value of the hysteresis.
Mains export power 2 3242	<b>Mains export power, limit value 2</b> The mains export power has exceeded or fallen below the limit value 2 for mains export power for at least the configured time and does not fall below or exceed the value of the hysteresis.
Mains import power 1 3217	<b>Mains import power, limit value 1</b> The mains import power has exceeded or fallen below the limit value 1 for mains import power for at least the configured time and does not fall below or exceed the value of the hysteresis.
Mains import power 2 3218	<b>Mains import power, limit value 2</b> The mains import power has exceeded or fallen below the limit value 2 for mains import power for at least the configured time and does not fall below or exceed the value of the hysteresis.

Message text ID	Meaning
Mains overfreq. 1 2862	<b>Mains overfrequency, limit value 1</b> The mains frequency has exceeded the limit value 1 for mains overfrequency for at least the configured time and does not fall below the value of the hysteresis.
Mains overfreq. 2 2863	<b>Mains overfrequency, limit value 2</b> The mains frequency has exceeded the limit value 2 for mains overfrequency for at least the configured time and does not fall below the value of the hysteresis. Triggering this monitoring function causes the mains decoupling function to trigger.
Mains overvoltage 1 2962	<b>Mains overvoltage, limit value 1</b> The mains voltage has exceeded the limit value 1 for mains overvoltage for at least the configured time and does not fall below the value of the hysteresis.
Mains overvoltage 2 2963	<b>Mains overvoltage, limit value 2</b> The mains voltage has exceeded the limit value 2 for mains overvoltage for at least the configured time and does not fall below the value of the hysteresis. Triggering this monitoring function causes the mains decoupling function to trigger.
Mains PF lagging 1 2985	<b>Mains overexcited, limit value 1</b> The power factor limit 1 has been exceeded at the mains interchange point towards inductive (i.e. the current is lagging) for at least the configured time and does not fall below the value of the hysteresis.
Mains PF lagging 2 2986	<b>Mains overexcited, limit value 2</b> The power factor limit 2 has been exceeded at the mains interchange point towards inductive (i.e. the current is lagging) for at least the configured time and does not fall below the value of the hysteresis.
Mains PF leading 1 3035	<b>Mains underexcited, limit value 1</b> The power factor limit 1 has fallen below at the mains interchange point towards capacitive (i.e. the current is leading) for at least the configured time and does not exceed the value of the hysteresis.
Mains PF leading 2 3036	<b>Mains underexcited, limit value 2</b> The power factor limit 1 has fallen below at the mains interchange point towards capacitive (i.e. the current is leading) for at least the configured time and does not exceed the value of the hysteresis.
Mains phase shift 3057	<b>Mains phase shift</b> A mains phase shift, which has exceeded the configured limit, has occurred. Triggering this monitoring function causes the mains decoupling function to trigger.
Mains df/dt 3106	<b>Mains df/dt (ROCOF)</b> A mains df/dt, which has exceeded the configured limit, has occurred. Triggering this monitoring function causes the mains decoupling function to trigger.
Mains underfreq. 1 2912	<b>Mains underfrequency, limit value 1</b> The mains frequency has fallen below the limit value 1 for mains underfrequency for at least the configured time and has not exceeded the value of the hysteresis.
Mains underfreq. 2 2913	<b>Mains underfrequency, limit value 2</b> The mains frequency has fallen below the limit value 2 for mains underfrequency for at least the configured time and has not exceeded the value of the hysteresis. Triggering this monitoring function causes the mains decoupling function to trigger.
Mains undervoltage 1 3012	<b>Mains undervoltage, limit value 1</b> The mains voltage has fallen below the limit value 1 for mains undervoltage for at least the configured time and has not exceeded the value of the hysteresis.

Message text ID	Meaning
Mains undervoltage 2 3013	<b>Mains undervoltage, limit value 2</b> The mains voltage has fallen below the limit value 2 for mains undervoltage for at least the configured time and has not exceeded the value of the hysteresis. Triggering this monitoring function causes the mains decoupling function to trigger.
Maint. days exceeded 2560	<b>Maintenance days exceeded</b> The generator run time has exceeded the configured number of days since the last maintenance period. Additionally, the alarm has not been acknowledged.
Maint. hrs exceeded 2561	<b>Maintenance hours exceeded</b> The generator run time has exceeded the configured number of operating hours since the last maintenance period. Additionally, the alarm has not been acknowledged.
MCB fail to close 2623	<b>MCB failed to close</b> The easYgen has attempted to close the MCB the configured maximum number of attempts and failed. Depending on the configuration, the easYgen will continue to attempt to close the GCB as long as the conditions for closing the MCB are fulfilled.
MCB fail to open 2624	<b>Failed MCB open</b> The easYgen is still receiving the reply "MCB closed" after the MCB open monitoring timer has expired.
MCB syn. timeout 3074	<b>MCB synchronization time exceeded</b> The easYgen has failed to synchronize the MCB within the configured synchronization time.
Missing members 4064	<b>Missing load share members detected</b> The easYgen has detected that the number of available units for load sharing does not correspond with the configured number of members.
Mns act. pwr mismatch 2934	<b>Mains active power mismatch</b> The deviation between the import/export power and the active import/export power setpoint has exceeded the limit for at least the configured time.
Mns. ph. rot. mismatch 3975	<b>Mains rotating field mismatch</b> The mains rotating field does not correspond with the configured direction.
Mains volt. incr. 8834	<b>Mains voltage increase</b> The mains voltage has exceeded for a longer time period the voltage increase criteria.
Time-dep. voltage 4958	<b>Time-dependent voltage</b> The measured voltage falls below/exceeds the configured criteria.
QV monitoring 1 3288	<b>QV monitoring, delay time 1</b> The generator reactive power has exceeded the limit for at least the configured delay time 1.
QV monitoring 2 3289	<b>QV monitoring, delay time 2</b> The generator reactive power has exceeded the limit for at least the configured delay time 2.
Operat. range failed 2664	<b>Measured values not within operating range</b> An alarm will be issued if ignition speed is exceeded and the measured values for generator and/or mains are not within the configured operating range. No alarm will be issued in idle mode.
Overspeed 1 2112	<b>Engine overspeed, limit value 1</b> The engine speed has exceeded the limit value 1 for engine overspeed for at least the configured time and does not fall below the value of the hysteresis.



Message text ID	Meaning
Overspeed 2 2113	<b>Engine overspeed, limit value 2</b> The engine speed has exceeded the limit value 2 for engine overspeed for at least the configured time and does not fall below the value of the hysteresis.
Parameter alignment 4073	<b>LDSS parameter mismatch detected</b> The easYgen has detected that not all LDSS parameters are configured identically at all participating units. Refer to <a href="#">Chapter 4.4.6.11 "Multi-Unit Parameter Alignment" on page 209</a> for a list of all monitored parameters.
Ph. rotation mismatch 2944	<b>Generator/busbar/mains phase rotation different</b> Generator, busbar (easYgen-3400/3500 only), and mains have different rotating fields. A CB closure is blocked.  The phase rotation monitoring is always enabled and cannot be disabled.
Red stop lamp 15125	<b>Red stop lamp, J1939 interface</b> This watchdog monitors, whether a specific alarm bit is received from the CAN J1939 interface. This enables to configure the control in a way that a reaction is caused by this bit (e.g. warning, shutdown). No alarm can be indicated if the CAN communication fails.
Speed/freq. mismatch 2457	<b>Difference in frequency/speed measurement alarm</b> The speed differential between the generator frequency (ascertained by the generator voltage measurement) and the engine speed (measured by the MPU) has exceeded the configured limit value / differential frequency for at least the configured time and has not fallen below the value of the hysteresis. The alarm may also be triggered if the LogicsManager "ignition speed" is enabled and no electrical frequency is detected as well as the other way round.
Start fail 3325	<b>Failure of engine to start alarm</b> The generator set has failed to start after the configured number of attempts. Depending on the configuration, no more start attempt will be carried out until the alarm is acknowledged.
Unbalanced load 1 2412	<b>Generator unbalanced load, limit value 1</b> The generator current has exceeded the limit value 1 for generator unbalanced load for at least the configured time and does not fall below the value of the hysteresis.
Unbalanced load 2 2413	<b>Generator unbalanced load, limit value 2</b> The generator current has exceeded the limit value 2 for generator unbalanced load for at least the configured time and does not fall below the value of the hysteresis.
Underspeed 1 2162	<b>Engine underspeed, limit value 1</b> The engine speed has fallen below the limit value 1 for engine underspeed and has not exceeded the value of the hysteresis.
Underspeed 2 2163	<b>Engine underspeed, limit value 2</b> The engine speed has fallen below the limit value 2 for engine underspeed and has not exceeded the value of the hysteresis.
Unintended stop 2652	<b>Unintended Stop</b> The easYgen expects the generator to be running but a sudden underrun of the ignition speed has been detected.
{Analog input x}	<b>Analog input {x}, wire break</b> During measurement of the analog input a wire break was detected. This text may be assigned customer defined. The text in angular brackets is the default text.  Refer to <a href="#">"Message IDs for analog inputs" on page 746</a> and <a href="#">"Message IDs for external analog inputs" on page 746</a> .

Message text ID	Meaning
{Discrete input x}	<p><b>Discrete input {x}, energized / de-energized</b></p> <p>The actual state of the monitored discrete input is energized / de-energized (depending on the configuration) for at least the configured time. This text may be assigned customer defined. The text in angular brackets is the default text.</p> <p>Refer to ☞ “<i>Message IDs for discrete inputs</i>” on page 746.</p>
{Ext. Discrete input x}	<p><b>External discrete input {x}, energized / de-energized</b></p> <p>The actual state of the monitored external discrete input is energized / de-energized (depending on the configuration) for at least the configured time. This text may be assigned customer defined. The text in angular brackets is the default text.</p> <p>Refer to ☞ “<i>Message IDs for external discrete inputs</i>” on page 747.</p>
{Flexible limit x}	<p><b>Flexible threshold {x}, overrun / underrun</b></p> <p>The actual value of the monitored analog value has exceeded / fallen below the threshold (depending on the configuration) for at least the configured time and does not fall below / exceed the value of the hysteresis. This text may be assigned customer defined. The text in angular brackets is the default text.</p> <p>Refer to ☞ “<i>Message IDs for flexible limits</i>” on page 747.</p>

**Message IDs for analog inputs**

Analog input #	1	2	3
Message ID	10014	10015	10060

**Message IDs for external analog inputs**

External analog input #	1	2	3	4	5	6	7	8
Message ID	10221	10222	10223	10224	10225	10226	10227	10228

External analog input #	9	10	11	12	13	14	15	16
Message ID	10229	10230	10231	10232	10233	10234	10235	10236

**Message IDs for discrete inputs**

Discrete input #	1	2	3	4	5	6	7	8	9	10	11	12
Message ID	10600	10601	10602	10603	10604	10605	10607	10608	10609	10610	10611	10612

## Message IDs for external discrete inputs

External discrete input #	1	2	3	4	5	6	7	8
Message ID	16360	16361	16362	16364	16365	16366	16367	16368

External discrete input #	9	10	11	12	13	14	15	16
Message ID	16369	16370	16371	16372	16373	16374	16375	16376

External discrete input #	17	18	19	20	21	22	23	24
 P2: package 2 only.								
Message ID	16202	16212	16222	16232	16242	16252	16262	16272

External discrete input #	25	26	27	28	29	30	31	32
 P2: package 2 only.								
Message ID	16282	16292	16302	16312	16322	16332	16342	16352

## Message IDs for flexible limits

Flexible limit #	1	2	3	4	5	6	7	8	9	10
Message ID	10018	10019	10020	10021	10022	10023	10024	10025	10026	10027

Flexible limit #	11	12	13	14	15	16	17	18	19	20
Message ID	10028	10029	10030	10031	10032	10033	10034	10035	10036	10037

Flexible limit #	21	22	23	24	25	26	27	28	29	30
Message ID	10038	10039	10040	10041	10042	10043	10044	10045	10046	10047

Flexible limit #	31	32	33	34	35	36	37	38	39	40
Message ID	10048	10049	10050	10051	10052	10053	10054	10055	10056	10057

## 9.6 Formulas

### 9.6.1 Load Dependent Start Stop (LDSS) Formulas

The following formulas are used by the load-dependent start/stop function to determine whether a genset is to be started or stopped.

**Abbreviations**

Abbreviation	Parameter	
$PGN_{real\ active}$		Momentary active generator real power on the busbar
$P_{rated\ active}$		Momentary active generator rated power on the busbar
Preserve		$P_{rated\ active} - PGN_{real\ active}$
$P_{reserve\ isolated}$	5760	Minimum permissible reserve power on busbar in isolated operation
$P_{hysteresis\ IOP}$	5761	hysteresis in isolated operation
$PMN_{setpoint}$		Export / import power control setpoint
$PMN_{real}$		Momentary active power at the interchange point
$PMOP_{minimum}$	5767	Minimum requested generator load
$P_{reserve\ parallel}$	5768	Minimum permissible reserve power on busbar in mains parallel operation
$P_{hysteresis\ MOP}$	5769	$P_{hysteresis}$ in mains parallel operation
$P_{max.\ load\ isolated}$	5762	Maximum permissible generator load in isolated operation
$P_{min.\ load\ isolated}$	5763	Minimum permissible generator load in isolated operation
$P_{max.\ load\ parallel}$	5770	Maximum permissible generator load in mains parallel operation
$P_{min.\ load\ parallel}$	5771	Minimum permissible generator load in mains parallel operation

**LDSS mode "Reserve Power"**

Task	Formula
<b>Isolated Operation</b>	
Changing the Engine Combination to Increase Rated Power	$PGN_{real\ active} + P_{reserve\ isolated} > P_{rated\ active}$
Changing the Engine Combination to Reduce Rated Power	$PGN_{real\ active} + P_{reserve\ isolated} + P_{hysteresis\ IOP} < P_{rated\ active}$
<b>Mains Parallel Operation (Import/Export Control)</b>	
Starting the First Engine Combination (no engine supplies the busbar)	$PMN_{setpoint} - PMN_{real} + PGN_{real\ active} > PMOP_{minimum}$
Changing the Engine Combination to Increase Rated Power	$PMN_{setpoint} - PMN_{real} + PGN_{real\ active} + P_{reserve\ parallel} > P_{rated\ active}$
Changing the Engine Combination to Reduce Rated Power	$PMN_{setpoint} - PMN_{real} + PGN_{real\ active} + P_{reserve\ parallel} + P_{hysteresis\ MOP} < P_{rated\ active}$
Stopping the Last Engine Combination (load close to minimum load)	$PMN_{setpoint} - PMN_{real} + PGN_{real\ active} < PMOP_{minimum} - P_{hysteresis\ MOP}$

**LDSS mode "Generator Load"**

Task	Formula
<b>Isolated Operation</b>	
Changing the Engine Combination to Increase Rated Power	$PGN_{real\ active} > P_{max.\ load\ isolated}$
Changing the Engine Combination to Reduce Rated Power (except dynamic setpoint is not matched)	$PGN_{real\ active} < P_{min.\ load\ isolated}$
<b>Mains Parallel Operation (Import/Export Control)</b>	

Task	Formula
Starting the First Engine Combination (no engine supplies the busbar)	$PMN_{\text{setpoint}} - PMN_{\text{real}} + PGN_{\text{real active}} > PMOP_{\text{minimum}}$
Changing the Engine Combination to Increase Rated Power	$PGN_{\text{real active}} > P_{\text{max. load parallel}}$
Changing the Engine Combination to Reduce Rated Power (except dynamic setpoint is not matched)	$PGN_{\text{real active}} < P_{\text{min. load parallel}}$
Stopping the Last Engine Combination (load close to minimum load)	$PMN_{\text{setpoint}} - PMN_{\text{real}} + PGN_{\text{real active}} < PMOP_{\text{minimum}} - P_{\text{hysteresis MOP}}$

## LDSS dynamic

Dynamic characteristic	= [(max. generator load – min. generator load) * dynamic] + (min. generator load)	
Dynamic power level	= (dynamic characteristic) * (generator rated power)	
Constants	Low dynamic	= 25 %
	Moderate dynamic	= 50 %
	High dynamic	= 75 %

### Example for moderate dynamic

- Dynamic characteristic = [(80 % – 40 %) \* 50 %] + (40 %) = 60 %
- Dynamic power level = (60 %) \* (200 kW) = 120 kW

## 9.7 Additional Information

### 9.7.1 D-SUB Connector Housing

Some housings for D-Sub connectors are too wide to plug them into the unit properly. If your serial or CAN bus cable is equipped with a housing, which does not fit into the easYgen socket, you may replace the housing with one of the following housings:

Manufacturer	Type/Order No.
FCT (www.fctgroup.com)	FKH1 FKC1G
Wuerth Electronic (www.we-online.de)	618009214622 260809 41800927911

### 9.7.2 CAN Bus Pin Assignments Of Third-Party Units



**"For your information only ..."**

The following pin assignments are typically by third-party units.

For the CAN Bus pin assignments of your Woodward device please go to [Chapter 3.4 "CAN Bus Interfaces"](#) on page 80.

#### D-SUB DE9 connector

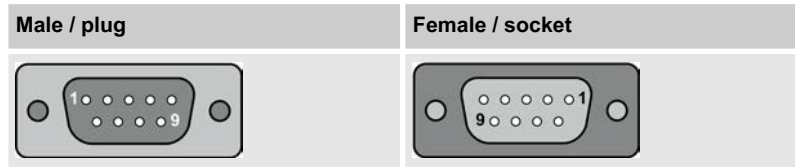

Terminal	Signal	Description
1	-	Reserved
2	CAN_L	CAN Bus Signal (dominant low)
3	CAN_GND	CAN ground
4	-	Reserved
5	(CAN_SHLD)	Optional shield Connected with connector housing and internally grounded via RC element
6	(GND)	Optional CAN ground
7	CAN_H	CAN Bus Signal (dominant high)
8	-	Reserved
9	(CAN_V+)	Optional external voltage supply Vcc

Table 105: Pin assignment

#### RJ45/8P8C connector

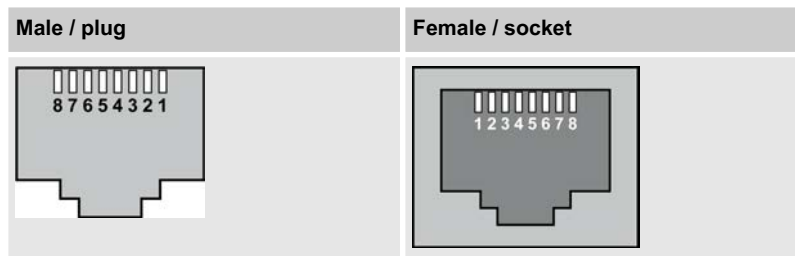

Terminal	Signal	Description
1	CAN_H	CAN bus line (dominant high)
2	CAN_L	CAN bus line (dominant low)
3	CAN_GND	Ground / 0 V / V-
4	-	Reserved

Terminal	Signal	Description
5	-	Reserved
6	(CAN_SHLD)	Optional CAN Shield
7	CAN_GND	Ground / 0 V / V-
9	(CAN_V+)	Optional external voltage supply Vcc

Table 106: Pin assignment

IDC/header connector

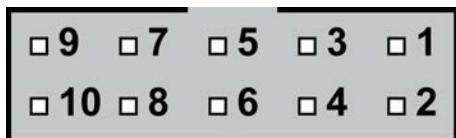

Fig. 305: IDC/header connector

Terminal	Signal	Description
1	-	Reserved
2	(GND)	Optional CAN ground
3	CAN_L	CAN bus line (dominant low)
4	CAN_H	CAN bus line (dominant high)
5	CAN_GND	CAN ground
6	-	Reserved
7	-	Reserved
8	(CAN_V+)	Optional external voltage supply Vcc
9	(CAN_SHLD)	Optional shield
10	-	Not connected

Table 107: Pin assignment





## 10 Glossary And List Of Abbreviations

<b>AM</b>	AnalogManager
<b>BDEW</b>	German community of 1,800 companies represented by the German Association of Energy and Water Industries (Bundesverband der Energie- und Wasserwirtschaft)
<b>CB</b>	Circuit Breaker
<b>CL</b>	Code Level
<b>CT</b>	Current Transformer
<b>DI</b>	Discrete Input
<b>DO</b>	Discrete (Relay) Output
<b>ECU</b>	Engine Control Unit
<b>FMI</b>	Failure Mode Indicator
<b>GCB</b>	Generator Circuit Breaker
<b>GGB</b>	Generator Group Breaker
<b>HMI</b>	Human Machine Interface e.g., a front panel with display and buttons for interaction
<b>I</b>	Current
<b>IOP</b>	Isolated Operation in Parallel ("Isolated Parallel Operation")
<b>LDSS</b>	Load-Dependent Start/Stop operation
<b>LM</b>	LogicsManager©
<b>MCB</b>	Mains Circuit Breaker
<b>MOP</b>	Mains Operation in Parallel
<b>MPU</b>	Magnetic Pickup Unit
<b>N.C.</b>	Normally Closed (break) contact
<b>N.O.</b>	Normally Open (make) contact
<b>NC</b>	Neutral Contactor
<b>OC</b>	Occurrence Count
<b>Operation</b>	In (general) operation.  State when the genset is running according to the selected mode, all parameters are in allowed values and ranges, and without OPEN requests or alarms. Somehow "waiting for next occurrence".
<b>P</b>	Real power
<b>P/N</b>	Part Number
<b>PF</b>	Power Factor
<b>PID</b>	Proportional Integral Derivative controller
<b>PLC</b>	Programmable Logic Control
<b>PT</b>	Potential (Voltage) Transformer
<b>Q</b>	Reactive power
<b>S</b>	Apparent power
<b>S/N</b>	Serial Number
<b>SPN</b>	Suspect Parameter Number
<b>V</b>	Voltage



## 11 Index

<b>A</b>		
Alarms	199	
Free configurable	200	
<b>B</b>		
Battery		
Monitoring	207, 208	
BDEW	146	
<b>C</b>		
CAN		
Bus Overload	201	
J1939 Interface	204	
Monitoring	202, 203	
Contact person	25	
Critical Mode	294	
Customer Service	25	
<b>D</b>		
Droop	345	
<b>E</b>		
Engine		
Operating Range Failure	180	
Overspeed	171	
Shutdown Malfunction	178	
Speed Detection	173	
Start Failure	178	
Underspeed	172	
Unintended Stop	179	
Engine/Generator		
Active Power Mismatch	175	
Unloading Mismatch	177	
Engine/Mains		
Active Power Mismatch	176	
<b>G</b>		
GCB	188	
Application	225	
Synchronization	189	
Generator		
Ground Fault	125	
Inverse Time-Overcurrent	131	
Lagging Power Factor	134	
Overfrequency	110	
Overvoltage	113	
Phase Rotation	129	
Reverse/Reduced Power	117	
Speed Detection	173	
Unbalanced Load	122	
Underfrequency	112	
Undervoltage	115	
Voltage asymmetry	124	
Grid Code	146	
<b>I</b>		
Intended use	25	
IOP	288	
Isolated Parallel Operation	288	
<b>J</b>		
J1939 Interface	204, 205, 206	
<b>L</b>		
LDSS	281	
Load Control	308	
Load Dependent Start Stop	281	
Load Share Control	336	
<b>M</b>		
Mains		
Blocking protection	170	
Change Of Frequency	159	
Decoupling	140	
Export Power	166	
Import Power	164	
Lagging Power Factor	167	
Leading Power Factor	169	
Operating Voltage / Frequency	139	
QV Monitoring	157	
Time-Dependent Voltage	154	
Underfrequency	148	
Undervoltage	151	
Voltage Increase	152	
Voltage Phase Rotation	163	
Mains Parallel Operation	291	
MCB	190	
Application	229	
Measurement		
Parameters	94	
MOP	291	
<b>P</b>		
Personnel	26	
Phase Rotation		
Generator/Busbar/Mains	193	
PID Control	347	
Power Factor Control	327	
Protective equipment	30	
<b>S</b>		
Service	25	
Symbols		
in the instructions	23	
<b>T</b>		
Temperature		
Cylinder Temperature	182	
<b>U</b>		
Use	25	
<b>V</b>		
VDE-AR-N 4105	143	
Voltage Control	323	
<b>W</b>		
Warranty	25	







**Woodward GmbH**

Handwerkstrasse 29 - 70565 Stuttgart - Germany

Phone +49 (0) 711 789 54-510

Fax +49 (0) 711 789 54-101

[stgt-info@woodward.com](mailto:stgt-info@woodward.com)